

gegr. 1892

Wilh. Breuer

## GASTRONOMIE- UND SERVIERARTIKEL

FOOD SERVICE EQUIPMENT  
EQUIPAMIENTOS PROFESIONALES  
EQUIPEMENT PROFESSIONNEL



2017

# Produktqualität und Energieeffizienz bei Profi-Geräten

- Hocheffiziente Kältesysteme für eine deutliche Senkung des Energieverbrauchs und der Betriebskosten
- Serielle Bus-Schnittstelle, potentialfreier Kontakt und Infrarot-Schnittstelle ermöglichen die Vernetzung mit zentralen Dokumentations- und Alarmsystemen
- Bedarfsgesteuerte Heißgasabtauung macht zusätzlichen Energieaufwand unnötig und gewährleistet Abtauzeiten von nur ca. 10 Minuten
- Chrom-Nickelstahl Außengehäuse und tiefgezogener Innenbehälter mit Reinigungsablauf sind hygienisch und pflegeleicht



## Seite/page

15 APS+ / ASIA+



20



25



36



42



43

45

Servierartikel aus Melamin  
 serving items melamine  
 artículos de servicio en melamina  
 pièces de service en mélamine



46



50



57



76



123

135

Servierartikel  
 serving items  
 artículos de servicio  
 pièces de service



137



142



174



177



187

191

Buffet . Banquet  
 buffet . banquet  
 buffé . catering  
 buffet . catering



193



244



257



210



271

273

Chafing Dish  
 chafing dish  
 chafing dish  
 chafing dish



274



280



289



292



296

297

GN . GN-Zubehör  
 GN . GN-extras  
 GN . GN-extras  
 bacs et accessoires GN



301



304



309



310



314

319

Bar . Wein  
 bar . wine  
 bar . vino  
 bar . vin



324



330



340



362



380

381

Kaffee . Körbe  
 coffee . basket  
 café . cestas  
 café . corbeilles



389

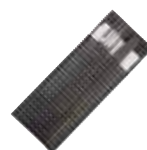

410



412



423



444

447

Kochen . Backen  
 cooking . baking  
 la cocina . repostería  
 cuisinier . pâtisserie



449



451



453



455



456

469

Werkzeug  
 kitchentool  
 cocinas herramientas  
 cuisines l'outil



474



487



490



494



500

503

Zubehör . Hauben  
 spare parts . covers  
 recambios . tapas  
 pièces de rechange . cloches



506



506



508



509



510

# NEUHEITEN NEWS NOVEDADES NOUVEAUTÉS 2017



ASIA+ - Seite/page 34-44



Becher „MOSCOW MULE“ - Seite/page 333



Table Caddy „VINTAGE“ - Seite/page 411



Isolierkannen - Seite/page 444-446



STONE ART - Seite/page 46-49



ENAMELWARE - Seite/page 145-147



FLOWER POT - Seite/page 59



Buffetsystem „SUPERBOX“ - Seite/page 192-195



Chafing Dish „WINDOW“ - Seite/page 280



FRIDA - Seite/page 56-58



Snack Holder - Seite/page 136-139

## Icon-Index / Material-Index

 <b>neuer Artikel</b> new item	 <b>spülmaschinengeeignet</b> dishwasher-proof	 <b>für Induktionsplatten</b> for induction use	 <b>Inhaltsangabe</b> volume
 <b>niedriger Preis</b> hot price	 <b>nicht spülmaschinengeeignet</b> not dishwasher-proof	 <b>kühlbar</b> for cooling	
 <b>Made in Germany</b>	 <b>abwaschbar / wasserfest</b> water-proof	 <b>doppelwandig</b> double wall	
 <b>1-a-Profiqualität</b> prime quality	 <b>mikrowellengeeignet</b> microwave-proof	 <b>bruchsicher</b> shatter-proof	
 <b>APS-Design</b>	 <b>nicht mikrowellengeeignet</b> not microwave-proof	 <b>Eigenmontage</b> self assembly	
 <b>GN-Größen</b> GN norm	 <b>keine direkte Hitze</b> not direct heat	 <b>für Lebensmittelkontakt</b> food safe	
 <b>stapelbar</b> stackable	 <b>nicht für Backofen</b> not for baking oven	 <b>nicht für Lebensmittelkontakt</b> non food safe	

### APS - BSCI-Mitglied

APS engagiert sich für die Verbesserung von Arbeitsbedingungen. Wir sind Partner der europäischen Organisation BSCI. Die "Business Social Compliance Initiative" (BSCI) ist eine Initiative von Unternehmen zur Verbesserung der Arbeitsbedingungen in der globalen Versorgungskette.

### APS is a member of BSCI

APS is committed to the improvement of working conditions. APS is a partner of the European organization BSCI. BSCI "Business Social Compliance Initiative" is an initiative of enterprises to improve working conditions in the global supply chain.



### APS Melamin - Garantierte Qualität

APS Melaminprodukte entsprechen der Richtlinie EG1935/2004 und 10/2011 der Europäischen Kommission. Diese enthält Bestimmungen für Materialien aus Kunststoff, welche mit Lebensmitteln in Berührung kommen. Wir arbeiten sehr eng mit den Zertifizierungsinstitutionen Intertek und TÜV zusammen und können somit die Lebensmittelechtheit (LFGB Regulation) der APS Melaminartikel garantieren.

### APS Melamine - Guaranteed quality

APS melamine products comply with directive EG1935/2004 and 10/2011 of the European Commission. This contains provisions for plastic materials which come into contact with foodstuffs. We work very closely together with the certification institutions Intertek and TÜV, and are therefore able to guarantee the compatibility with foodstuffs (German LFGB regulation) of APS melamine articles.

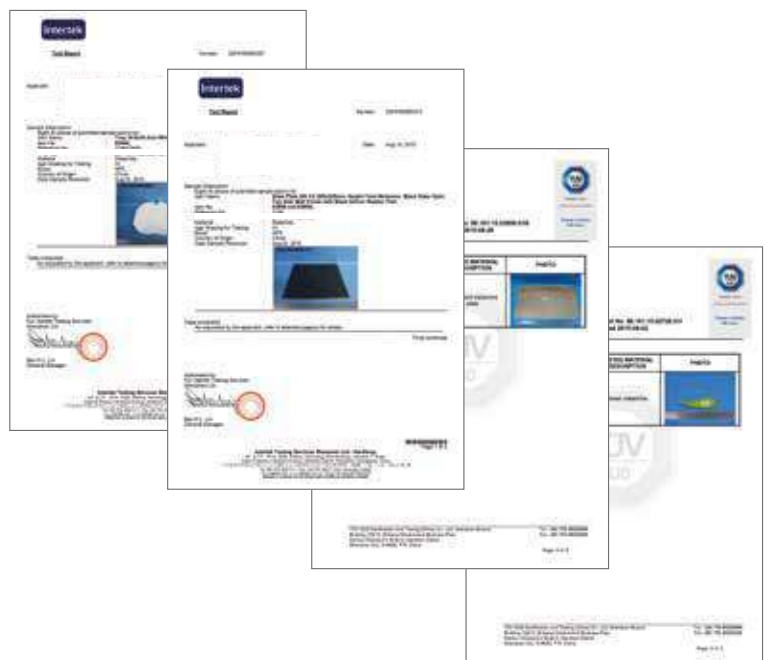

**Edelstahl 18/10 / Stainless steel 18/10**

Werkstoff 1.430 rostfrei; langlebig; schlechter Wärmeleiter, daher gute isolierende Eigenschaften; absolut hygienisch und nicht toxisch; recyclebar; nicht resistent gegen dauerhaften Kontakt mit Chloriden und Säuren (z.B. Kochsalz und Fruchtsäuren); sterilisierbar; Oberfläche lässt sich vielfältig polieren; nicht magnetisch; ab 400°C Verfärbungen

Pflege: pflegeleicht; maschinell oder per Hand mit milden Spülmitteln; möglichst keine Stahlwolle u.ä. verwenden; nach Erhitzung Schockabkühlung vermeiden

**Edelstahl (unspezif.) / Stainless steel (unspecific)**

niedrig nickelhaltige Edelstähle wie 14/4, nicht magnetisch, geringere allgemeine Resistenz als Edelstahl 18/10  
Pflege: siehe Edelstahl 18/10

**Edelstahl 18/0 / Stainless steel 18/0**

Werkstoff 1.4016 rostfrei und langlebig bei entsprechender Pflege: absolut hygienisch und nicht toxisch; gut härtbar, daher idealer Stahl für Tafelmesser, Tablets, Schneidwerkzeuge u.ä.; lässt sich hochglanzpolieren; für Nickel-Allergiker geeignet; magnetisch; hitzeresistent wie Edelstahl 18/10; nicht so chemikalienresistent wie Edelstahl 18/10

Pflege: maschinell oder per Hand mit milden Spülmitteln; Ablagerung von Kalk und Reinigerresten nach dem Spülen unbedingt entfernen; niemals mit Stahlwolle reinigen

**Eisen / Iron**

nicht rostfrei; charakteristische strukturierte Oberfläche mit unterschiedlichen Schattierungen; durch wiederholten Schmiedevorgang ist das Material stark verdichtet und sehr hart; langlebig bei entsprechender Pflege

Pflege: vor Kocheinsatz mit Öl und Kartoffelschalen „einbraten“, später nach jeder Reinigung immer einfetten; trocken lagern

**Gusseisen / Cast Iron**

langlebig bei entsprechender Pflege; geeignet für alle Herdarten (incl. Induktion); speichert lange Wärme und gibt sie gleichmäßig ab; absolut hygienisch bei unbeschädigter Oberfläche; relativ schweres Material; Überhitzung fast nicht möglich; nicht schlagfest; magnetisch

Pflege: nach Gebrauch sofort mit heißem Wasser füllen; bei Fleckenbildung mit Essig nachreinigen; niemals mit Stahlwolle reinigen; milde Spülmittel verwenden

**Versilberter Stahl / Silver plated steel**

Edelmetall; nicht völlig säurefest; nicht längere Zeit Sonnenlicht aussetzen

Pflege: niemals scheuernde Hilfsmittel verwenden; nur mit weichen Lappen und Spezialmitteln reinigen, keine Spülmaschinenreinigung!

**Verchromter Stahl / Chrome plated steel**

nichtedles Metall mit hartem Chromüberzug; nicht säurefest, nach Beschädigung der Chromschicht kein Schutz gegen Umwelteinflüsse

Pflege: niemals scheuernde Hilfsmittel verwenden; nur mit weichen Lappen

**Aluminium**

sehr leichtes Material; sehr gute elektrische und thermische Leitfähigkeit; korrosionsbeständig; nicht spülmaschinengeeignet; Gebrauchstemperatur bis 500°C

**Porzellan**

hitzebeständig bis 220°C

**ABS – Acrylnitril-Butadien-Styrol**

sehr gute Oberflächenhärte; temperaturwechselfest; spülmaschinengeeignet; Gebrauchstemperatur bis ca. +100 °C

**ACRYL – künstliches Harz**

farblos; glasartig; durchsichtig; nicht splitternd; chemisch modifiziert als Plexiglas®; wichtiger Pflegehinweis: nur handelsübliche Acrylspezialreiniger oder milde alkohol- und ammoniakfreie Reinigungsmittel verwenden; nicht spülmaschinengeeignet; Gebrauchstemperatur ca. -40 °C bis ca. +50 °C

**MF - Melamin**

sehr hart; stoß- und kratzfest; hygienisch; säurebeständig; spülmaschinengeeignet; Gebrauchstemperatur ca. -30 °C bis +70 °C

**MS - Kunststoff**

farblos; glasartig; durchsichtig; nicht spülmaschinengeeignet; Gebrauchstemperatur ca. 0 °C bis ca. +70 °C

**PA - Polyamid**

starr; bruch- und schlagfest; mattglänzend; Gebrauchstemperatur bis ca. +220 °C

**PC - Polycarbonat**

starr; nahezu unzerbrechlich; sehr stabil; formbeständig in kochendem Wasser; spülmaschinengeeignet; mikrowellengeeignet; Gebrauchstemperatur ca. -30 °C bis ca. +100 °C

**PE - Polyethylen**

HDPE - hochdichtes Polyethylen  
hart elastisch; unzerbrechlich; ausreichend formbeständig in heißem Wasser; glänzend; Gebrauchstemperatur ca. -40 °C bis ca. +120 °C

NDPE - niederdichtes Polyethylen  
weich elastisch; unzerbrechlich; kurzzeitig formbeständig in heißem Wasser; nicht glänzend; Gebrauchstemperatur ca. -40 °C bis ca. +95 °C

**PP - Polypropylen**

hart elastisch; unzerbrechlich; umweltschonend recyclebar; spülmaschinengeeignet; mikrowellengeeignet; Gebrauchstemperatur ca. -30 °C bis ca. +75 °C

**PS - Polystyrol**

starr; kratzfest; formbeständig in kochendem Wasser; Gebrauchstemperatur bis ca. +70 °C

**PVC – Polyvinylchlorid**

säurebeständig; schwer entflammbar; Gebrauchstemperatur ca. -50 °C bis ca. +60 °C

**SAN - Styrol-Acrylnitril**

gute Oberflächenhärte; temperaturwechselfest; spülmaschinengeeignet; Gebrauchstemperatur bis ca. +100 °C

**Silikon**

hohe thermische Beständigkeit; gute Kälteflexibilität; Gebrauchstemperatur ca. -70 °C bis ca. +180 °C

# Laserlogo Individual

perfekte Lasergravuren  
perfectly Laser engravings  
grabado perfecto por láser  
marcage laser parfait



Unverwechselbar - Einzigartig - Imagefördernd  
Ihre individuelle Lasergravur von APS

Wir bieten Ihnen die Möglichkeit, unsere Produkte mit Ihrem individuellen Logo per Laser zu gravieren - einzigartig, unverwechselbar und bereits ab 10 Stück je Artikel. Die perfekte Beschriftung durch modernste Lasertechnologie ist spülmaschinenfest und somit dauerhaft auf allen Edelstahl- und Naturschieferprodukten, sowie auf versilberten und verchromten Metall-Artikeln umsetzbar. Machen Sie aus Ihren Gastronom-Behältern Ihre ganz persönlichen Unikate und werten Sie Ihre Servierartikel mit Ihrem eigenen Logo auf.

- **geringe Mindestbestellmenge von nur 10 Stück**
- **kurze Lieferzeiten**
- **Logos bis zu einer Fläche von max. 10 x 10 cm realisierbar**

Distinct - Unique - Image enhancing  
Your individualised laser engraving by APS

We offer you the option of having your personalised logo engraved on our products - inimitable, unique, and available for delivery from only 10 pieces per product. The perfect inscription by use of the newest technology is dishwasher-safe and thus can be permanently applied to products made of stainless steel and natural slate, as well as silver-coated and chromed metal articles. Turn your gastronomy container into your individual, one of a kind article and enhance your serving items with your own logo.

- **minimum order quantity of only 10 pieces**
- **swift delivery**
- **feasible logos are those with a maximum size of 10 x 10 cm**

Único, personalizado, promotor de imagen  
Grabado laser por APS

Podemos grabar su logo y así personalizar los productos APS a partir de mínimo 10 unidades por referencia. Gracias a la novedosa tecnología de grabado por láser, la inscripción es perfecta y resistente al lavavajillas. Se puede aplicar a los artículos en acero inoxidable, pizarra natural, metal cromado y plateado.

- **Cantidad mínima de solamente 10 unidades**
- **Realización rápida**
- **Tamaño de logos hasta máximo 10 x 10 cm**

Unique, original, porteur d'image  
Marcage laser par APS

Nous pouvons graver votre logo et ainsi personnaliser les produits APS à partir de 10 pièces par référence. Grâce à une technologie d'avant-garde de marcage par laser, l'inscription est parfaitement reproduite et résistante au lave-vaisselle. Ce type de marcage peut s'appliquer sur l'acier inoxydable, sur l'ardoise naturelle, sur le métal chromé ou argenté.

- **Quantité minimum de seulement 10 unités**
- **Fabrication rapide**
- **Taille du logo jusque 10 x 10 cm**



<b>Artikel</b>	<b>Seite</b>		
<b>A</b>		<b>C</b>	
Abdeckhauben	105, 112, 129, 127 143, 144, 160, 174, 175, 176, 205	Cerealien-Karaffe	228
Abfallbehälter	365, 439-443	Cerealispender/-Bar	198, 227-230
Abräumwagen	314, 315	Chafing-Dish	274-276, 278-284 286-288, 294
Abtropfmatte/Bar-Matte	349	Chafing-Dish Suppen-Kugel Globe	277, 278
Adapter/Zwischensteg	301	Chafing-Dish Suppentopf/-station	289
Allzweckgießer	420		290
Antirutschmatte	40	Chafing-Dish Window	280
Apfelentkerner, -schäler	474, 475, 476	Champagnerkühler	324-326
Aschenbecher/Standascher	361-364	Champagnerverschluss	356-358
Aufstrichmesser	482	Clips für Beschriftungsschilder	133
Ausgießer	355, 356	Cloche	25, 180
Auslageschalen	126, 127	Cocktail-Doppelmaß	345
Aufsteller	373	Cocktailmesser	338, 477
Ausstecher	470, 471	Container	315
Ausstellblech	464	<b>D</b>	
Austernöffner/-messer	475	Darioform	455
<b>B</b>		Deckel / Frischhaltedeckel	21, 105, 112 127, 197, 250-252, 509, 510
Backblech/-form	303, 463, 464	Deckel Bain-Marie	289
Bäckerpaletten	479-481	Deckel SAN	127
Backhandschuhe	459	Dekoriermesser	474, 476
Baquettekörbe	385, 387, 396	Dip-Schälchen/ -Schale Melamin	80 112, 116
Bain-Marie-Einsatz	289	Dispenser Iso	263
Bar-Caddy/Löffel/Set/Sieb	342-344, 350	Dispenser Kaffee	263
Barmaße	345	Dispenser Saft/Milch	264-272
Barmatte	349	Doppelmaß	345
Becher	122, 145, 333	Dose Vorrat	226, 258, 460
Becher Melamin	53, 122	Dosier-/Vorratsflasche	353, 354
Behälter/Schale Melamin	19-23, 28, 36, 47, 48, 50, 53, 55-59, 67, 70-73, 76-93, 95, 97, 99, 101, 103-106, 109, 112, 113, 115-117, 123, 128, 129, 130, 203, 235, 258, 442	Dosierer Zucker	420, 421
Beilagenschale	136-139, 169	Dosierspender	457
Bento Box	39	Drehplatte	465
Beschriftungsfähnchen	369	Dressingtopf	93, 132, 189, 190
Beschriftungskarten	366, 369	<b>E</b>	
Besteck-Ablage/Ständer/Körbe	118 199, 206, 258, 282, 309 310, 390, 396, 397	Eierbecher	122, 179
Besteckköcher	309, 310, 397	Eier-Box/Korb	179, 311, 400
Bestecksammler/Behälter/Kasten	113 303, 308-310, 439, 440	Eierschneider	493
Bestecktasche	410	Einmachglas	154-157, 227
Bialetti Moka-Express	432	Eisbox / Eiseimer	206, 322, 334 335, 350
Bierglasträger	354	Eis-Kugel/Würfel-Former	336
Bitter Bottle	356	Eisportionierer	492
Blattschale	27, 55, 57, 75, 86, 110 111, 197	Eisschaufel	337, 501
Blumenvasen	374	Eiswaffelständer	468
Bonspieß/-leiste	461	Eiswürfelbehälter	335
Boston-Shaker	340, 341	Eiszange	334, 337, 498
Bratenplatte	173	Eiszerkleinerer	336, 338
Brennpastenbehälter	291	Emallie Servierartikel	145-147
Brezel-/Wurstständer	219	Entkerner Apfel/Zucchini	474-476
Brötchen-Spender	255, 384	Entstieler	474
Brotkorb	396, 398, 399, 401-403	Essig- / Öl-Gläser / Menagen	412-415
Brottschneidebrett	256, 257	Etagere	25, 114, 151, 213 214, 217, 218
Brotstation	255, 384	<b>F</b>	
Brottasche Baumwolle	400, 401	Fadenschneider	472
Buffet-Brett Holz	143, 144, 172 238, 239	Fast-Food Tablett	141, 183
Buffet-Gestell	100, 204, 206, 207, 212 225, 253, 254, 395	Fettabstecher	480, 482
Buffet-Gestell für Körbe	100, 212 253, 395	Feuerzange	294
Buffet-Leiter	204, 220, 221, 222, 223	Feuerzangenbowle	294
Buffet-Set	151, 202, 237, 241	Fingerfood-Löffel/-Teller	85, 116, 124 125
Buffet-Ständer	29, 33, 42, 43, 173 208, 209, 210, 211, 226, 227	Fischtenschupper/-zange	478, 497
Buffet-Vitrine	242-247	Fischplatte / Fischschale	114, 115, 172
Butter- und Saucenwärmer	296	Flaschenausgießer	355-358
Butterdose Kühlschrank	178	Flaschen Display	360
Butterroller	473	Flaschenhalter Wein	360
Butterservierer	178	Flaschenhalterung mit Portionierer	356
		Flaschenkühler	199, 329-332
		Flaschenöffner	328, 351
		Flaschenträger	354
		Flaschenverschluss	356-358
		Fleisch-/Gemüseplatte Edelstahl	158
		Fleischgabel/Tranchiergabel	316, 318 484, 488
		Folien-Abreibvorrichtung	468
		Fondantrichter	450
		Frischhaltedeckel	105, 112, 127, 156 197, 250-252, 509, 510
		Frischhaltehauben	120, 143, 393 504-508
		Fritier- und Servierkorb	136, 137
		Fritierlöffel	450
		Fruchtsaftpressen	347
		<b>G</b>	
		Gabel Pellkartoffel	474
		Garnierschneider Dreieck	475
		Gebäckzangen	494, 498, 499
		Gemüsemesser	477
		Gewürzkasten	459
		Gewürzstreuer/ -mühlen	423-428
		Glas-/Spiegelplatte	153, 174
		Gläserhalter/-schiene	354, 360
		Glasumranden	336
		Glocke/Cloche	180
		GN Behälter/ Deckel Polypropylen	305
		GN-Abtropfgitter Polycarbonat	304
		GN-Behälter Edelstahl mit Fallgriff	301
		GN-Behälter Edelstahl perforiert	300
		GN-Behälter Melamin	97, 128, 129 306, 307
		GN-Behälter Porzellan	306
		GN-Behälter/ Deckel Edelstahl	299-302
		GN-Behälter/ Deckel Polycarbonat	127 129, 160, 304
		GN-Deckel Polyethylen luftdicht	302
		GN-Konvektomatenblech	302
		GN-Roste	303
		GN-Steckdeckel	299-302
		GN-Tablett	30, 31, 49, 63-67 69, 74, 94, 97 99, 102, 103, 105 121, 127, 148, 149, 153, 159, 162 163, 170, 171, 224
		Gourmet-Gläser	154-157
		Gourmetlöffel	140, 189
		Grapefruitmesser	476
		Grillzange	498
		Grissini-Halter	402
		<b>H</b>	
		Haube	23, 25, 143, 393, 504-508
		Heizelement Elektro	280, 285, 293
		Heizung Mobil für Chafing Dish	293
		High Tea Rack	207
		Hobel	219, 478, 491
		Holzbox	192-195, 256, 410, 411, 440
		Hot Plate	292
		Hüllen für Speisekarten	370
		Hummerbrecher	493
		Hygieneschutz	219, 255
		<b>I</b>	
		Induktionskochplatte	274-278, 292
		Iso-Dispenser	263
		Isolierkanne	444-446
		<b>J</b>	
		Jigger	345
		Julienneschneider	477
		<b>K</b>	
		Kaffeebecher	122
		Kaffeedispenser	285
		Kaffeekanne	432, 444-446
		Kanne/Karaffe Saft-/Wasser/-Milch	260-263, 429-430, 432, 444-446
		Kartenhalter	366-372
		Kartoffelstampfer	491
		Käseglocke/Set	240
		Käsemesser, Käsehobel	219, 477, 478
		Kaviarkühler	188
		Kelle Suppe	316-318, 484 486-489, 496
		Kellnermesser/ -flaschenöffner	351
		Kerzenleuchter, Windlichter	375-380
		Konditorplatte	120, 151, 168 174-176, 465-467
		Konfitürenbehälter	250-252
		Konservator Champagner-/Sekt	357
		Korb Edelstahl	42, 136, 137, 402, 403
		Korb Metall verchromt	401
		Korb Polypropylen	113, 205, 253 383-394, 396-400
		Korkenzieher	352
		Kreidestift	366, 372
		Kronkorkenöffner/-Sammelbehälter	352
		Kuchen-/Quiche-Form	463
		Kuchenblech	464
		Kuchenheber	497
		Küchentuchständer	460
		Kugelausstecher	470, 471
		Kühlakku	510
		Kühlbox/-tablett	196, 202, 225 242-249
		Kühler Champagner	199, 324-326
		Kühler Flaschen	199, 329-332
		Kühler Konferenz	199, 328
		Kühler Wein/Sekt	199, 320-322 326, 327
		Kühlmanschette	332
		Kühlschale	188, 189, 197, 250-252
		<b>L</b>	
		Likör-/Fondantrichter	450
		Limettenpresse	346
		Löffel Feinkost/Salat/Dressing	84, 131 132, 502
		<b>M</b>	
		Matte	349
		Mehlschaufel	501
		Melamin-Schale	19-27,
		Melamin-Tablett	115
		Menage	107, 412-419
		Messbecher	429, 453
		Messer Cocktail	351
		Messerabstreichbehälter	468
		Messerbänkchen	433
		Messerhalter Magnet	461
		Messkanne	429, 453
		Messlöffelsatz	493
		Metallrahmen für Induktionsplatte	
		ERGÄNZEN !!! MP	
		Milch Dispenser / Milch Kanne	269 270, 429
		Milchgießer/-kännchen	429, 430
		Milch-Zucker Set	430
		Mühlen	423-425
		Müllbeuteleimer	365
		Multibox	113, 258, 434
		Multi-Rack	207, 232, 233
		Multistreuer	426-428
		Muschelschale/-topf	188
		Müslispender	198, 227-230
		Moscow Mule Becher	333
		<b>N</b>	
		Naturschieferplatte	148-152, 157 159, 423
		<b>P</b>	
		Palette	142, 479-481
		Palmblattschale	110, 111
		Parmesan-Menagen	418
		Party-Löffel	124, 125
		Partyplatte	170, 171
		Passiermühle	452
		Passiersieb	451
		Pastetenform	455
		Permanent-Ausgießer	355, 356
		Pendelschäler	478
		Pfanne	449
		Pfannenwender	318, 485, 487, 495
		Pfeffermühlen	423-425
		Pinself	459
		Pinzettzange	500

Pitcher	262, 343
Pizzaform/-bleche	449
Pizzaroller/-heber/-schaufel/-schieber	459, 473, 482, 483
Platzteller	180
Pommes-Frites Schaufel	491
Pommes-Frites Seiher	451
Portionierer	492
Portionsspender	431
Porzellan-Einsatz	278
Pendelschäler	474
Pump-Isolierkanne	446
<b>Q</b>	
Quetschflasche	141, 456, 457
<b>R</b>	
Rechnungstablett	181
Rechteckschalen/Wanne	311
Regalwagen	315
Reinigungsbürste für Ausgießer	359
Rezeptionsglocke	354
Rolltop Deckel Kunststoff	120, 143
	202, 240, 394, 505, 506
Rolltop-Deckel Edelstahl	288
Rolltop-Set	241
Rost	303
Rührglas	343
<b>S</b>	
Saft/Milch Dispenser	198, 264-268
	271, 272
Salatgabel/-löffel	132, 486, 496
Salatschleuder	457
Salz-/Pfefferstreuer	428
Salzmühlen	423-425
Saucen- und Butterwärmer	296
Saucengießlöffel	497
Sauciere	177
Sauciere Thermo	177
Schälchenspender	234, 235
Schale/ Schüssel Edelstahl/Glas	169
	189, 197, 234, 403, 458, 510
Schale Emaille	145, 147
Schale Melamin, Blatt	27, 55, 57, 75
	86, 110, 111, 197
Schale/Schüssel Melamin	19-23
	28, 36, 47, 48, 50, 53, 55-59
	67, 70-73, 76-93, 95, 97, 99, 101
	103-106, 109, 112, 113, 115-117
	123, 130, 203, 235, 258, 442
Schäler Spargel/Orange/Sparschäler	472
Schaufel Pommes-Frites / Eis / Mehl / Mehrzweck	491, 501
Schaumlöffel	317, 486, 487
Schaumspeisering/-form	454
Schieferplatte Natur	148-152, 157, 159
Schilder für Buffet	366-369
Schilderhalter	133, 367
Schlüsselschnur	359
Schnapspistole	357
Schneebesen/Kesselbesen	490
Schneidebrett	202, 256, 257, 338, 458
Schöpflöffel	316-318, 484, 486-489
Schüssel Wasserbad	452
Schutzdeckel	510
Seiher	139, 451, 458
Sektflaschenverschluss	357, 358
Sektkühler	199, 320-322, 326, 327
Sektkühlerstände	323
Senftöpfchen	417
Service Tower	231
Servier-/Buffetplatte Porzellan	190
Servier-/Tortenplatte Edelstahl	168
	174-176, 465-466
Servier-/Tortenplatte Melamin	120, 121
	175, 176, 241, 466, 467
Servier-/Transportwagen	314, 315
Servierbrett	142, 143
Servier-Eimer / -Becher	138, 139

Servier- und Frittierkorb	136, 137
Serviergestell	107, 108, 113, 155
	214-216, 253
Servierlöffel	134, 316-318, 484
	486-489, 495
Servierpfanne Schmiedeeisen/Eisen	448
Servierpfanne/Beilagenschale	139, 169
Servierschale	169, 294, 295
Serviertablett	119, 141, 170
	182-187, 432
Serviertopf	188, 189, 452
Serviettenhalter	436-438
Serviettenringe	433
Shaker	340, 341
Sicherheitsbrenner Hot&Safe	291
Sieb Suppe/Passier/Gaze	450-452
Snack-Holder	136, 137-139
Snackpresenter	259
Spachtel	480, 482
Spaghettilöffel/-zange	317, 486, 487
	489, 497
Spargelschäler	471
Speisekartenhalter	370-371
Speisenwärmer/Stövchen	295, 296
Spießaufhänger	492
Spieße Holz/Edelstahl	492
Spritzbeutel	462
Spritzflasche	356
Standascher	364, 365
Ständer Bankettkarten	371
Ständer Eiswaffel	467
Ständer Küchentuch	460
Ständer Schneidbrett	461
Ständer Weinkühler	323
Staubkappen	359
Stift	366, 372
Stielkasserolle	452
Stößel	339
Stövchen	295, 296
Streichpaletten	479
Streuer Käse/Gewürz	426, 427
Streuer Salz/Pfeffer	428
Stufen-Display	212
Suppenkelle	316-318, 484
	486-489, 496
Suppentopf / Suppenstation	283
	289, 290
Sushiboard / Sushiplatte	115
<b>T</b>	
Table Caddy	410, 411, 440
Tablett Aluminium	464
Tablett Edelstahl	106, 158-168, 173
	202, 203, 224, 352
Tablett Edelstahl mit Haube	160, 165
	167, 168, 225
Tablett Edelstahl, System	159-163, 224
	312
Tablett Fastfood	141
Tablett Holz	29
Tablett Kaffeehaus	186, 187
Tablett Melamin	25, 30, 31
	40, 41, 49, 51, 53, 60-76, 81-83, 86
	87, 90, 91, 84, 102, 103, 105, 115, 119
	121, 127, 172, 206, 216, 256, 423
Tablett, metallverchromt	170-171
Tablett/Bierglasträger	182-184
Tablett/Partyplatte	170, 171
Tasse	53, 122
Teebeutel Ablage/Halter	435
Teebox	434
Teebrühsieb	435, 493
Teigschneider/-schaber	473, 483
Teiler Apfel/Zwiebel	479
Teller	37, 46, 47, 52, 54, 55, 70-74
	81, 84, 86, 103, 122, 146
Teller Melamin	103
Thekenaufsatz/Vitrine/Mini-Theke	259

Thermo Set/Tablett	242, 243, 249
Thermo-Box	312
Tischaufsteller/-kartenhalter/-nummer	366-372
Tischkrümel-Entferner	443
Tischrestebehälter	439-443
Tischsets, Tischläufer	309, 404-409, 438
Torten-/Desserttring	463
Tortenhaube	120, 174, 175, 176
Tortmesser/-heber	497
Tortenplatte	120, 151, 168
	174-176, 465-467
Tortenteiler	464
Tourniermesser	476
Tranchiergabel	495
Tretabfallbehälter	365
Tüllenkassetten	462
Türsymbole	373
<b>U</b>	
Universalbox	206, 258, 442
Universalkanne	429, 453
Untersetzer	152, 157, 181, 423, 448
Untertasse	53
<b>V</b>	
Vakuum-Pumpe Ersatzstopfen	359
Vakuum-Pumpe Wein	359
Vase	374
Verschluss Wein/Champanger	356-358
Vorlegebesteck	316-318
	484-489, 495-497
<b>W</b>	
Wachspapier	140
Wagen	314, 315
Wanne	204, 311
Warenträger	171, 409, 422
Wärme-Kies	295
Weck-Glas	154-157
Warnschild	373
Wein- / Sektkühler	320-323, 326, 327
Weinausgießer	357
Weinex-Ausgießer	357
Weinflaschenhalter	360
Wender	317, 318, 480-483
	485, 487-489, 495
Windaschenbecher	361-363
Windlicht	378-380
Winkelpaletten	480, 481
<b>Z</b>	
Zange Salat/Toast/Allzweck	486, 494
	498, 499
Ziseliermesser	471, 472
Zitronen-/Limettenpresse	346, 347
Zitronenschnittpresse	435, 500
Zitruspresse	347
Zitrusteiler	347
Zuckerdose/-kugel/-spender	430, 431
Zuckerdosierer	420, 421
Zuckertüten-Box	431
Zutatenbehälter	350

## ENGLISH

item	page
<b>A</b>	
adapter	301
apple / onion divider	479
apple corer/courgette / zucchini cutter	474, 475, 476
ashtray/litter bin	361-364
asparagus knife	471
asparagus knife / asparagus peeler/ orange peeler/peeler	472
<b>B</b>	
bain marie bailing bowl	452
baking mittens	459
baking sheet	303, 463, 464
baking tray	464
bar knife	338, 351, 477
bar-set/bar spoon/bar strainer/bar caddy	342-344, 350
barbecue tong	498
basket	113, 205, 253, 383-394
	396-400, 401
basket for bread or fruits/bowl	42, 136, 137, 402, 403
beer rack	354
Biatelli	432
bill presenter	181
bill rail/bill spike	461
board	29, 143, 144, 172, 238, 239
boston shaker	340, 341
bottle cap opener/bottle cap holder	352
bottle rack	354
bowl	80, 112, 116
bowl holder	234, 235
bowl melamin	19-28, 36, 47, 48
	50, 53, 55-59, 67, 70-73, 76-93, 95
	97, 99, 101, 103-106, 109, 112
	113, 115-117, 123, 130, 203
	235, 258, 442
box / sweetbox	206, 258, 442
bread basket with cherry stones pillow/ canvas bag	400, 401
bread buffet	255, 384
breadstick holder	402
brush	459
buffet ladder	204, 220, 221, 222, 223
buffet stand	100, 204, 206, 207, 212
	225, 253, 254, 395
buffet stand for baskets	100, 212
	253, 395
buffet stand, riser with cover	29, 33
	42, 43, 173, 208-211, 226, 227
burner holder	291
butter curler	473
butter dish	178
<b>C</b>	
cake / quiche mould	463
cake lifter	497
cake marker	464
cake plate	120, 151, 168
	174-176, 465-467
cake setting ring/dessert and tart ring	463
cake slice/cake lifter	497
cake tray/plate	120, 121, 151, 168
	173-176, 241, 465-467
candleholder/wind light	375-380
canister with spoon	226, 258, 460
caviar cooler	188
cereal dispenser/cereal-bar	198
	227-230
cereal pitcher	228
chafing dish	274-276, 278-284
	286-288, 294
champagne bowl	199, 324-326

champagne conservator	357	GN tray	30, 31, 49, 63-67, 69, 74, 94	non-stick loaf tin	455	soup ladle	316-318, 484
champagne saver	356-358		97, 99, 102-103, 105, 121, 127, 148	<b>O</b>			486-489, 496
cheese dish	240, 418		149, 153, 159, 162-163, 170-171, 224	oyster knife	475	soup warmer	283, 289, 290
cheese knife	219, 477, 478	GN-container melamin	97, 128, 129	<b>P</b>		space box	426, 427
chip bagger/chip shovel/scoop	491, 501		306, 307	palette	142, 479-481	spaghetti spoon/spoon	317, 486
		GN-container polycarbonate	127, 129				487, 489, 497
			160, 304	paper towel holder/kitchen roll holder	460	spatula	480, 482
citrus squeezer/lime press	346, 347	GN-container polypropylene	305	paring knife	476-477	spits/skewer	492
clingfilm tear-off-dispenser, single	468	GN-container porcelain	306	party spoon	85, 116, 124, 125	spoon	134, 316-318, 484
cloche / dome cover	180	GN-convection oven trays	302	partytray	170, 171		486-489, 495
coaster	53, 152, 157, 181, 423, 448	GN-cover, airtight	302	pastry bag	462	squeeze bottle	141, 456, 457
coffee cup	53, 122	GN-drainer	304	pedal bin	365	stainless bowl, double wall/bowl	169, 189, 197, 234, 403, 458, 510
coffee dispenser	263, 285	GN-grids / -shelves	303	pepper mill	423-425	stand for wine cooler	323
coffee pot	432, 444-446	GN-lid with rubber seal	299-302	perforated GN-container	300	stand/bowl	19-23, 28, 36, 47
condiment container	459	GN-pans with folding handles	301	pipng tubes set	462	48, 50, 53, 55-59, 67, 70-73, 76-93 95	97, 99, 101, 103-106, 109, 112, 113
condiment holder	350	gourmet spoons	140, 189	pitcher	262, 343	115-117, 123, 128, 129, 130, 203	235, 258, 442
confectionery funnel	450	graduated jug	429, 453	pitcher/cooling carafe/juice / water			
conference bottle cooler	199, 328	granite chips	295	pitcher/bottle	260-263, 429-430		
container	204, 311	grapefruit knife	476		432, 444-446		
container/cutlery basket/dispenser/		gravy boat	177	pizza dish	449	stopper	356-358
cutlery box/table waste bin / cutlery bin	113, 303, 308-310, 439, 440	greaseproof paper squares	140	pizza peel/pizza cutter	459, 473	strainer/conical strainer with wire	
cool bowl	188, 189, 197, 250-252	<b>H</b>			482, 483	gauze	450-452
cool collar	332	heating element	293	placemat wide band/table runner fine		sugar bowl/sugar pot/sugar pourer	430, 431
cooler	199, 329-332, 510	heating unit	280, 285, 293	fabric	309, 404-409, 438	sugar dispenser	420, 421
cooling plate/showcase	196, 202	High Tea Rack	207	plate / cake plate	168, 174-176	sugar pocket holder	431
	225, 242-249	hot plate	292		465-466	sugar-creamer-set	430
corer	474	hygienic cover	219, 255	plate tray	180	table caddy	410, 411, 440
cornet stand	467-468	<b>I</b>		plate warmer/warmer	295, 296	table stand/sign	366-372
cover	23, 25, 143, 393, 504-508	ice ball former/cooler for 4 shooters	336	plate, rotating	465	table waste bin / cutlery bin	439-443
cover for bain marie	289		336	plate, round	103	table waste bin / cutlery bin / box	365, 439-443
cover hinged	510	ice box/ice bucket	206, 322, 334	porcelain insert	278		
cover, SAN	127		335, 350	portioner / ice cream scoop	492	tea bag rest, 2 pcs. Set/tea bag caddy	435
crumber	443	ice crusher	336, 338	potato holder	474	tea-box	434
curler/cheese slicer	219, 478, 491	ice scoop	337, 501	pourer	420	thermo tray	242, 243, 249
cutlery basket	309, 310, 397	ice tong	334, 337, 498	pourer cleaning brush	359	thermobox	312
cutlery rest/cutlery basket/cutlery		induction plate for chafing dish		pouring container	353, 354	tray	106, 119, 141, 158-168, 170
dispenser	118, 199, 206, 258, 282		274-278, 292	pretz- sausage stand	219		173, 182-187, 202, 203, 224
	309, 310, 390, 396, 397	insulated dispenser	263	<b>R</b>			312, 352, 432
cutting board	256, 257	insulated sauce boat	177	refillable burner	291	tray „NON SLIP“	182-184
cutting board rack	461	<b>J</b>		refrigerator butter dish	178	tray melamin	25, 30, 31
<b>D</b>		jigger	345	ring bell	354		40, 41, 49, 51, 53, 60-76, 81-83, 86
dariol moulds	455	juice dispenser/milk dispenser	198	roll dispenser	255, 384		87, 90, 91, 84, 102, 103, 105, 115, 119
decorating knife	471, 472		264-268, 271, 272	rolltop cover	120, 143, 202, 240		121, 127, 172, 206, 216, 256, 423
decorator / radish decorator	475	juicer	347	rolltop-cover	288	tray with cover	160, 165, 167
decorator / zester	472	julienne cutting knife	477	rolltop-set	151, 202, 237, 241		168, 225
delicatessen spoon/salad spoon/		<b>K</b>		<b>S</b>		tray, sushiboard	115
dressing spoon	84, 131, 132, 502	key cord	359	salad fork/salad spoon	132, 486, 496	trolley/serving trolley	315
dish	190	knife cleaner	468	salad spinner	457	turner	317, 318, 480-483, 485
dispenser	431, 457	knife rest	433	salad tong/toast-tong/multipurpose			487-489, 495
display tray	464	<b>L</b>		tong	486, 494, 498, 499	vacuum wine pump	359
dressing pot/bowl, double wall		ladle	316-318, 484, 486-489	salt - and pepper shaker	428	vinegar-& oil menage	412-415
	93, 132, 189, 190	leaf	27, 55, 57, 75, 86, 110, 111, 197	salt mill	423-425	waiter's barblade	328, 351
drip mat	349	lemon slice squeezer	435, 500	sandwich knife	482	waiter's corkscrew	352
dust & fly cap	359	lime press	346	sauce / gravy ladle	497	warmer	294
<b>E</b>		<b>M</b>		service tower	231	Weck-glasses	154-157
egg cutter	493	magnetic knife rack	461	serving dish	136-139, 169	whisk/large whisk	490
egg holder	122, 179	meat fork/fork	316, 318, 484, 488		294-295, 449	wind lights	378-380
eggs-box/egg basket	179, 311, 400	meat platter	173	serving stand	107, 108, 113, 155	wine / champagne bowl	199
etagère	25, 114, 151, 213, 214	melon baller	470, 471		214-216, 253		320-323, 326, 327
	217, 218	menage	107, 412-419	serving trolley	314, 315	wine nozzle	357
expandable dough cutter/dough		menu cover	370	set measuring spoon	493	wine pump stopper	359
scraper	473, 483	menu stand / table number	371	shelf bracket with spirit measure	356	wine stopper	356-358
<b>F</b>		milk / cream jug/milk/cream jugs		showcase	242-247, 259	winebottle-stand	360
fire tong	294		429, 430	sign holder	133, 367	wrought-iron pan	448
fish platter/fish bowl	114, 115, 172	milk dispenser	269, 270, 429	sign holders, with 10 signs	133		
fish scaler/fish tong	478, 497	mill	423-425	sign plate	373		
flower vase	374	mixing glass with lip	343	signs set	366-369		
frame for induction plate	276-278	moulin / sieve	452	skewer / espetada and kebab skewer			
free flow pourers	355, 356	mousse ring/mousse mould	454	rack	492		
fruit decorating knife	474, 476	muddler	339	skimmer	317, 486, 487		
fry dripping tray	139, 451, 458	multi rack	207, 232, 233	skimmer / spider	450		
<b>G</b>		mussel bowl/mussel pot	188	snack tray	141, 183		
gastronorm-container	299-302	mustard glass	417	Snack-Holder	136, 137-139		
glass plate clips/glass rack	354, 360	<b>N</b>		snackpresenter	259		
glass platter/buffet glass plate		napkin holder	433, 436-438	snap mesh tea ball	435, 493		
	153, 174	natural slate tray GN	148-152	soup bowl	277, 278		
glass rimmer	336		157, 159				

# ESPAÑOL

## artículos pág.

<b>A</b>	
abre ostras	475
abridor camarero	328, 351
abridor de botellas/recogedor de chapas	352
acumulador de frío	510
adaptador	301
aros tarta/aro de tarta	463
azucarero	420, 421
azucarero pequeño	431
<b>B</b>	
bajo plato	180
bandeja	25, 106, 114, 119, 141, 151 158-168, 170, 173, 182-187, 202, 203 213, 214, 217, 218, 224, 312, 352, 432
bandeja „antideslizante“	182-184
bandeja aperitivos	141
bandeja autoservicio y snacks	141, 183
bandeja con tapa	160, 165, 167, 168 225
bandeja de fiesta	170, 171
bandeja de fiesta/bandeja party	170, 171
bandeja de pizarra natural GN	
	148-152, 157, 159
bandeja interior de porcelana	278
bandeja melamin	25, 30, 31, 40 41, 49, 51, 53, 60-76, 81-83, 86, 87 90, 91, 84, 102, 103, 105, 115, 119 121, 127, 172, 206, 216, 256, 423
bandeja para cerveza	354
bandeja para sushi	115
bandeja pastelera	464
Bandeja refrigerada/vitrina de bufet	
	196, 202, 225, 242-249
bandeja termo	242, 243, 249
bandeja vidrio, espejo/fuente de bufet para cristal	153, 174
bandeja/fuente de servicio	158
barra magnética para cuchillos	461
base giratoria	465
batidor/batidor gigante	490
bol alto para aliño/salsera alta/salsera alta doble pared	93, 132, 189, 190
bol azucar/azucarero/dispensador de azúcar	430, 431
bol de acero inoxidable, doble pared/bol	169, 189, 197, 234, 403, 458, 510
bol para marisco/mejillonera	188
bol refrigerado	188, 189, 197, 250-252
bomba de vacío para vino	359
bote con cuchara	226, 258, 460
bote contenedor	353, 354
bote dosificador/bote dosificador flexible	141, 456, 457
bread buffet	255, 384
brocha	459
<b>C</b>	
caddy de mesa	410, 411, 440
cafetera	432, 444-446
caja de 12 boquillas	462
caja para huevos/cesta de huevos	179 311, 400
caja para te	434
calentador para quemada	294
calienta platos/caliente	295, 296
campana	180
campana abatible	120, 143, 202, 240 394, 505, 506
campana rolltop	288
carro de servicio	314, 315
carro/carro de servicio	315
cazo para baño maría	452
cenicero/papelera con cenicero superior	361-364
centrifugadora de ensalada/ escurridor	457
cepillo de limpieza para picos vertedores	359
cesta	113, 205, 253, 383-394, 396-401
cesta de pan con cojín de huesos de cereza/cesta de tela para el pan	400, 401

cesta para cubiertos	309, 310, 397
cesta para pan o fruta/bol	42, 136, 137 402, 403
chafing dish	274-276, 278-284 286-290, 294
champañera	199, 320-322, 326, 327
coctelera boston	340, 341
colador/colador chino de malla	450-452
colector a pedal	365
conjunto de bar/cucharilla de cóctel/colador de cóctel/organizador de bar	342-344, 350
cortador 5 ruedas lisas/corta pasta	473, 483
cortahuevos	493
cubeta	204, 311
cubeta GN antiadherente para hornos de convección	302
cubeta GN policarbonato	127, 129 160, 304
cubetas gastronorm	299-302
cubetas GN melamin	97, 128, 129 306, 307
cubetas GN perforado	300
cubetas GN polipropileno	305
cubetas GN porcelana	306
cubetas/dispensador de cubiertos/dispensador de cubiertos/cesta para cubiertos/papelera de sobremesa	113, 303, 308-310, 439, 440 23, 25, 143, 393, 504-508
cubierta	219, 255
cubierta higiénica	206, 322, 334, 335, 350
cubitera	199, 324-326
cubo champañera	134, 316-318, 484 486-489, 495
cuchara de servicio	317, 486 487, 489, 497
cuchara de spaghetti/pinza	124, 125
cuchara party	85, 116, 124, 125
cucharas gourmet	140, 189
cucharas gourmet/cucharas/cuchara de aliño	84, 131, 132, 502
cucharón	316-318, 484, 486-489
cucharón de salsa	497
cucharón de sopa	316-318, 484 486-489, 496
cuchillo curvado	476
cuchillo de decoración	471, 472
cuchillo de queso	219, 477, 478
cuchillo par pomelo	476
cuchillo para cóctel	338, 351, 477
cuchillo para cortar juliana	477
cuchillo para pelar/cuchillo mondador	477
cuchillo para untar	482
cuenco melamin	19-23, 28, 36, 47 48, 50, 53, 55-59, 67, 70-73, 76-93, 95 97, 99, 101, 103-106, 109, 112, 113 115-117, 123, 130, 203, 235, 258, 442
cuencos para salsas	80, 112, 116
cuhillo para decorar fruta	474, 476
<b>D</b>	
decorador	472
decorador/cinzelador triangular	475
dispensador	206, 258, 442, 457
dispensador de bocadillos	259
dispensador de café	263, 285
dispensador de cereales/barra para dispensador de cereales	198, 227-230
dispensador de especias	350
dispensador de film	468
dispensador de leche	269, 270, 429
dispensador de panecillos	255, 384
dispensador de servilletas/soposte papel cocina	460
dispensador de zumo/dispensador de leche	198, 264-268, 271, 272
dispensador en escalera	204, 220, 221 222, 223
dispensador en escalera	207, 232, 233
dispensador isotérmico	263
dispensador/dispensador para servicio bebidas calientes	431
dosificador	420

<b>E</b>	
embudo dosificador	450
enfriador	199, 329-332
enfriador de caviar	188
enfriador múltiple	199, 328
escamador/pinza de pescado	478, 497
escurridor de fritos	451
escurridor de fritos/colador en formato	139, 451, 458
escurridor GN	304
espátula	142, 317, 318, 470-483, 485 487-489, 495
especiero	426, 427, 459
espumadera	317, 450, 486, 487
esterilla escurridora/tapete escurridor	349
estructura o marco para placa de inducción	276-278
expositor	107, 108, 113, 155 214-216, 253
expositor organizador/bol	19-23, 28, 36 47, 48, 50, 53, 55-59, 67, 70-73, 76-93 95, 97, 99, 101, 103-106, 109, 112 113, 115-117, 123, 128, 129, 130 203, 235, 258, 442
exprimidor	347
exprimidor cítricos/prensa de lima	346, 347
<b>F</b>	
florero	374
fuelle	190
fuelle de carne	173
fuelle de servir	449
fuelle de servir/fuelle de servicio	139, 169
fuelle en forma de hoja	27, 55, 57, 75 86, 110, 111, 197
fuelle honda	136-139, 169, 294, 295
fuelle pescado/cuenco para pescado	114, 115, 172
funda de frío	332
funda para carta	370
<b>G</b>	
GN bandeja	30, 31 49, 63-67, 69, 74, 94, 97 99, 102, 103, 105, 121, 127, 148, 149 153, 159, 162, 163, 170, 171, 224
GN cubetas con asas abatibles	301
granulado térmico	295
<b>H</b>	
huevera	122, 179
<b>I</b>	
indicadores de porcelana	366-369
infusor de te	435, 493
<b>J</b>	
jarra	262, 343
jarra de cereales	228
jarra graduada	429, 453
jarra medidora universal	429, 453
jarra/decantador/Jarra para zumo/ agua/ botella	260-263, 429-430, 432 444-446
juego 2 flaneras	455
juego 2 piezas vasos mostaza	417
juego 5 piezas aros para emplatar/juego 5 piezas molde para emplatar	454
juego de 2 piezas de sal y pimienta	428
juego de cucharas medidoras	493
<b>L</b>	
leche/ crema/jarras de leche/ crema	429, 430
limpiador de cuchillos	468
llavero enrollable	359
<b>M</b>	
manga pastelera	462
manoplas de cuero	459
mantelinas de mesa/camino de mesa	309, 404-409, 438
mantequillera	178
mantequillera para nevera	178
marcador de pasteles	464
marmita de sopa	277, 278
medidor	345
menaje/conjunto aperitivo	107
	412-419

molde de cubitos de hielo esféricos/ moldes para 4 cubitos de hielo	336
molde de pizza	449
molde pate o pastel liso	455
molde tarta o quiche	463
molinillo	423-425
molinillo de pimienta	423-425
molinillo de sal	423-425
molinillo/ colador	452
mortero	339
<b>P</b>	
pala de hielo	337, 501
pala de pizza/cortador de piza	459, 473 482, 483
pala para tarta	497
paleta triangular	480, 482
papel alimenticio para cucurucho	140
papelera de sobremesa	365 439-443
para presentar cuenta	181
pelador de espárragos	471
pelador de espárragos/pelador de naranjas/pelador de espárragos	472
picadora de hielo	336, 338
pictogramas	373
pie porta cubos	323
pinchos/piezas	492
pinza ensalada/pinza bocadillo/pinza multi-usos	486, 494, 498, 499
pinza exprimelímón	435, 500
pinzas barbacoa	498
pinzas para cubitos de hielo	334 337, 498
pinzas sujeta copas/rack de copas	354, 360
placa caliente	292
placa de inducción para chafing dish	274-278, 292
placa pastelera	303, 463, 464
plato redondo	103
porcionador de manzana -cebolla	479
porcionador de pastel/pala de tartas	497
porta botellas	354
porta grissini	402
porta indicadores, 10 indicadores	133
porta tartas	168, 174-176, 465-466
porta tartas/bandeja para servir	120, 121, 151, 168, 174-176, 241 465-467
porta tartas/porta tartas confitería	120, 151, 168, 174-176, 465-467
portafichas/pinchanotas	461
portavelas antiviento	378-380
portavelas/porta velas	375-380
posavasos	152, 157, 181, 423, 448
prensa de limón/lima	346 quemador recargable 291
<b>Q</b>	
quesera	240, 418
<b>R</b>	
racionador/ cuchara para helado	492
rack de te alto	207
recogemigas	443
recogedor para patatas fritas/pala para patatas fritas/pala	491
recogedor para patatas fritas/pala para patatas fritas/pala	491, 501
rejillas GN	303
reposa cuchara/cesta para cubiertos/dispensador de cubiertos	118, 199, 206 258, 282, 309, 310, 390, 396, 397
reposa cuchillos	433
resistencia	280, 285, 293
ribeteador de vasos	336
rizador de mantequilla	473
rizador/rebanador de queso	219 478, 491
<b>S</b>	
sacacorchos de camarero	352
salsera	177
salsera isotérmica	177
sartén forjada	448
service tower	231
servilletero	433, 436-438
set de aceite y vinagre	412-415

set de dos piezas para bolsita de te/ porta bolsitas de te	435
set para azúcar y crema	430
set roll top	151, 202, 237, 241
snack-holder	136-139
soporte 1 botella con medidor licores	356
soporte botella vino	360
soporte bufé	100, 204, 206, 207, 212, 225, 253, 254, 395
soporte de cestas para bufet	100, 212, 253, 395
soporte de mesa para carta/porta-etiqueta o carta de sobremesa con pinza	371
soporte para bol	234, 235
soporte para brochetas	492
soporte para bufet, display con tapa	29, 33, 42, 43, 173, 208, 209, 210, 211, 226, 227
soporte para cartelito	133, 367
soporte para cornetes	467, 468
soporte para el quemador	291
Soporte para embutidos	219
soporte para tablas	461
soporte/soporte para quemada	294
soportes/placa	366-372
<b>T</b>	
tabla de corte	256, 257
tabla para el buffet	29, 143, 144, 172, 238, 239
tapa GN hermética	302
tapa GN ranurada sellada/tapa GN hermética con junta	299-302
tapa para baño maría	289
tapa protección	510
tapa, SAN	127
tapete escurridor	349
tapón	359
tapón conservador	357
tapón para el cava	356-358
tapón para vino	356-358
tapones	356-358
tapones al vacío para el vino	359
taza de café	53, 122
tenedor aguanta patatas	474
tenedor de carne/tenedor	316, 318, 484, 488
tenedor para ensalada/cuchara para ensalada	132, 486, 496
termobox	312
timbre	354
<b>V</b>	
vaciador	474
vaciador de manzana/vaciador para calabacín	474, 475, 476
vaciador de melón	471
vasito con tapa	154-157
vaso mezclador vertedor con tapa/vaso mezclador vertedor con pico	343
vertedor de vino	357
vertedores continuos	355, 356
vitrina de bufet	242-247
vitrina de mostrador	259

## FRANÇAIS

item	pág.
<b>A</b>	
accumulateur de froid	510
adaptateur	301
anneaux à serviettes	433
anti-glisse	182-184
assiette	103
assiette de présentation	180
<b>B</b>	
bac à vaisselle	204, 311
bac GN anti-adhérent pour fours à convection	302
bac GN polycarbonate	127, 129, 160, 304
bac récupérateur de capsules/décapsuleur mural	352
bac supérieur en porcelaine	278
bac/bac à vaisselle	311
bacs gastronome	299-302
bacs Gastronorme melamin	97, 128, 129, 306, 307
bacs Gastronorme porcelaine	306
bacs GN avec anses abattantes	301
bacs GN en polypropylène	305
bacs GN perforés	300
bar à céréales/distributeur de céréales	198, 227-230
barre aimantée pour couteaux	461
base tournante	465
becs verseurs	357
beurrer	178
boîte à beure pour le frigo	178
boîte à épices ou ingrédients	459
boîte à fruits et ingrédients	350
boîte à oeufs/panier à oeufs	179, 311, 400
boîte à thés et infusions	434
boîte de 12 douilles	462
bol	80, 112, 116, 19-23, 28, 36, 47, 48, 50, 53, 55-59, 67, 70-73, 76-93, 95, 97, 99, 101, 103-106, 109, 112, 113, 115-117, 123, 130, 203, 235, 258, 442
bol inox double paroi/bol verre	169, 189, 197, 234, 403, 458, 510
bol melamin	19-24, 26
bols réfrigérés	188, 189, 197, 250-252
bordeur à verres „rimmer“	336
bouchon à champagne	356-358
bouchon à vin	356-358
bouchon anti-poussières et anti-insectes	359
bouchon de conservation	357
bouchons	356-358
bouchons verseurs continus	355, 356
boule à thé avec pince	435, 493
bouteille „store & pour“	353, 354
bouteille verseuse souple	141, 456, 457
brosse lave-bouchons doseurs	359
broyeur à glaçons	336, 338
brûleur	291
brûleur rechargeable	291
<b>C</b>	
caddy de table	410, 411, 440
cadre support inox pour plaque induction	276-278
cafetière Bialetti	432
caisson à couverts ou multi-usages/bac/présentoir à couverts/poubelle de table	113, 303, 308-310, 439, 440
caisson à couverts ou multi-usages/boîte distributrice/poubelle de table	206, 258, 442
caisson thermo	242, 243, 249

casier	360
cercles à gâteaux	463
chafing dish	274-276, 278-284, 286-288, 294
chafing dish 2 souprières	283, 289, 290
chandeliers/lampe à bougie	375-380
chariot de service	314, 315
chauffe-plat	295, 296
chauffe-plat spécial sucre flambé	294
clips porte-verre/rack porte-verres	354, 360
cloche	23, 25, 143, 393, 504-508
cloche demi-sphère	180
cloche rolltop GN1/1	120, 143, 202, 240, 394, 505, 506
coquetier	122, 179
coquilleur à beurre	473
corbeille	401
corbeille	113, 205, 253, 383-394, 396-400
corbeille à couverts	309, 310, 397
corbeille à pain ou à fruits/bol à pain ou à fruits	42, 136, 137, 402, 403
coupe-oeufs	493
coupe-pomme ou oignon en quartiers	479
couteau à fromage	219, 477, 478
couteau à huîtres	475
couteau à julienne	477
couteau à pamplemousse	476
couteau à tarte/pelle à gâteau	497
couteau à tartiner	482
couteau ciseleur triangle	475
couteau cocktail	338, 351, 477
couteau d'office	477
couteau d'office bec d'oiseau	476
couteau zesteur	472
couvercle avec charnière	510
couvercle GN1/1 du bain-marie	289
couvercle GN hermétique avec joint	299-302
couvercle hermétique GN	302
couvercle rolltop	288
couvercle SAN	127
crémier/pichet à eau ou lait	429, 430
cuillère à sauce	497
cuillère à spaghetti/pince universelle ou à spaghetti	317, 486, 487, 489, 497
cuillère de service	134, 316-318, 484, 486-489, 495
cuillère party	85, 116, 124, 125
cuillère/cuillères gourmet/cuillère à sauce	84, 131, 132, 502
cuillère/fourchette de service pour la salade/cuillère de service pour la salade	132, 486, 496
cuillères gourmet	140, 189
couteaux	468
<b>D</b>	
décapsuleur	328, 351
décore-citron ou zesteur	471, 472
découpoir à bandes „bicyclette“/coupe-pâte	473, 483
denteleur	474, 476
dérouleur de film	468
dérouleur papier essuie-tout	460
dispositif pour nettoyer les lames de distributeur de petits pains	255, 384
disque à marquer les parts	464
distributeur à jus de fruit/ distributeur à lait	264-272
distributeur à jus de fruit/distributeur à lait	198, 264-268, 271, 272
distributeur de boisson isothermique	263

distributeur de café	263, 285
doseur	420
doseur à sauce	457
<b>E</b>	
écaille à poisson/pince pour le poisson	478, 497
écumoire	317, 486, 487
écumoire à friture	450, 451
égouttoir GN	304
entonnoir à piston	450
équeuteur à tomates	474
essoreuse à salade	457
étagère à thé avec anse supérieure	207
étiquettes en porcelaine	369
<b>F</b>	
fouet professionnel/fouet géant	490
fourchette à viande/fourchette à viande	316, 318, 484, 488
frisette pour fromage et chocolat/ couteau tranche-fromage	219, 478, 491
<b>G</b>	
gants de boulanger	459
GN plat	30, 31, 49, 63-67, 69, 74, 94, 97, 99, 102, 103, 105, 121, 127, 148, 149, 153, 159, 162, 163, 170, 171, 224
gravier fin de granit	295
grille inox	303
<b>H</b>	
housse isotherme	332
<b>J</b>	
jeu de 2 moules à flan	455
jeu de cercles à mousse inox, ronds	454
jeu de cuillère à mesure	493
<b>L</b>	
louche	316-318, 484, 486-489
louche de service	316-318, 484, 486-489, 496
<b>M</b>	
marmite à soupe électrique	277, 278
ménage huile et vinaigre	412-415
mesure double „jigger“	345
mini cendriers/cendrier giratoire/ cendrier sur pied/poubelle ave cendrier supérieur	361-364
moule à glaçons en boules/moule 4 glaçons	336
moule à pizza	449
moule à pomme ou melon double	470
moule à tarte ou quiche	463
moule à terrine lisse	455
moulin à poivre	423-425
moulin à sel	423-425
<b>P</b>	
pain et buffet	255, 384
panera con cojin/corbeille à pain en toile	400, 401
papier alimentaire pour cornet	140
pare-haleine	219, 255
passoire	139, 451, 458
peleur à asperges	471
peleur à asperges/peleur à asperges/peleur à oranges	472
pelle à frites	491
pelle à frites/pelle à farine/pelle multi-usages	491, 501
pelle à glaçons	337, 501
pelle à pizza/pelle à pizza/roulette à pizza/roulette à pâte, cannelée/coupe-pizza/coupe-pâte	459, 473, 482, 483
pelle/plateau à gâteau	497
petits chevalets de buffet	366-369
pic à pommes de terre	474
pic/brochettes	492
pichet	262, 343

pichet à café	432, 444-446	porte-étiquette de table avec pince,	soucoupes pose-sachet/présentoir pour
pichet à céréales	228	porte-menu, ou n° de table, etc	sachets de thé
pichet gradué	429, 453	porte-sachetsw de sucre	435
pichet mesureur universel	429, 453	porte-serviettes	142, 317, 318, 479-483, 485
pichet verre/pichet rafraîchisseur/		portionneur à glace	487-489, 495
pichet à eau ou jus de fruit/bouteille	260-263, 429-430, 432, 444-446	pose-cuillère/égouttoir à couverts/	spatule coudée spéciale grill
pictogrammes	373	corbeille à couverts	480, 482
pied pour seau à champagne	323	258, 282, 309, 310, 390, 396, 397	sucrier
pilon muddler plastique	339	pot à lait mini	420, 421
pince à barbecue	498	pot en verre avec cuillère	sucrier/sucrier doseur
pince à glaçons	334, 337, 498	226, 258	430, 431
pince à salade/pince universelle multi- usages/pince à gâteaux	486, 494, 498, 499	poubelle à pédale	support à bretzel ou saucissons/ présentoir à bretzels ou à saucissons
pince presse-citron	435, 500	365	219
pinceau pâtissier	459	poubelle de table	support bouteille avec doseur
pique-bons/barre porte-bons	461	365, 439-443	356
planche à découper buffet	29, 143	présentoir	support buffet
	144, 172, 238, 239	107,108, 113, 155	100, 204, 206, 207
planche à découper pain et buffet	256, 257	214-216, 253	212, 225, 253, 254, 395
plaque à induction pour chafing dish	274-278, 292	présentoir à gâteaux	support cônes
plaque à pâtisserie	303, 463, 464	120-121, 168	467-468
plaque chaude	292	174-176, 241, 465-466	support multiple
plaque ségnalétique avec support/ chevalet de table/porte-étiquette	366-372	présentoir à mignardises	207, 232, 233
plat	106, 158-168, 173, 202	25, 114, 151	support pour brochettes
	203, 224, 352	213, 214, 217, 218	492
plat à tarte	120, 151, 168, 174-176	présentoir à sandwiches	support pour menu de table
	465-467	259	133, 367
plat ardoise naturelle GN	148-152, 157	présentoir buffet en escalier	support pour sucre à flamber
	159	204, 220	294
plat buffet	190	221, 222, 223	Supports + étiquettes
plat ceux à poisson/plat banquet	114	présentoir buffet pour corbeilles	133
	115, 172	100	
plat coquille/casserole à moules	188	212, 253, 395	<b>T</b>
plat creux pour la table	136-139, 169	présentoir buffet réfrigéré/plateau	tapis de bar
plat de service	158, 173	buffet froid	349
plat empilable système catering	159-163, 224, 312	196, 202, 225, 242-249	tapis de bar/tapis égouttoir pour
plat feuille	27, 55, 57, 75, 86, 110	présentoir buffet/pied à fruits de mer	étaqères
	111, 197	29, 33, 42, 43, 173, 208, 209, 210	349
plat melamin	25, 30, 31	211, 226, 227	tasse à café
40, 41, 49, 51, 53, 60-76, 81-83, 86		présentoir pour station café	53, 122
87, 90, 91, 84, 102, 103, 105		431	thermobox
115, 119, 121, 127, 172,		presse citron	312
206, 216, 256, 423		347	tire-bouchons sommelier
plat sushi	115	presse-agrumes	352
plateau	119, 141, 170, 182-187, 432	346, 347	tour de service
plateau à gâteaux avec pied	120, 151	presse-citron/presse citron	231
	168, 174-176, 465-467	346, 347	<b>V</b>
plateau avec cloche	160, 165, 167	presse-groisilles/passeoire/chinois	vase soliflor
	168, 225	renforcé avec maille fine	374
plateau avec sucrier et crémier	430	450-452	verre avec couvercle
plateau miroir en verre/plateau buffet		protège-menu transparent	154-157
en verre	153, 174	370	verre mélangeur avec bec verseur
plateau party	170, 171	<b>R</b>	343
plateau self-service et snacks	141, 1831	rack pour planches à découper	verres à moutarde
plateau sous-verre	152, 157, 181	461	417
	423, 448	rafraîchisseur à vin	vide-pomme/évideur à courgette
poche pâtissière	462	199, 329-332	475, 476
poêle à frire forgée	448	rafraîchisseur „conférence“	vitrine de buffet
poêle à frire/anses pour la table	449	199, 328	242-247
poêle à frire/plat creux pour la table	139, 169	rafraîchisseur de caviar	vitrine de comptoir
		188	259
pompe à vide pour le vin	359	ramasse-miettes	
porte verre sà bière	354	443	
porte- bâtonnets de pain (grissini)	402	réciipient bain-marie	
porte-addition	181	452	
porte-bols	234, 235	réciipient de table/bol	
porte-bougies anti-vent	378-380	19-23, 28, 36	
porte-bouteille	354, 360	47, 48, 50, 53, 55-59, 67, 70-73	
porte-clés avec câble à enroulement	359	76-93, 95, 97, 99, 101, 103-106, 109	
		112, 113, 115-117, 123, 128, 129	
		130, 203, 235, 258, 442	
		repose-couteaux	
		433	
		résistance	
		280, 285, 293	
		<b>S</b>	
		salière/set sel et poivre	
		428	
		saucière	
		177	
		saucière thermique	
		177	
		saucière/pot à sauce/pot à sauce	
		double paroi	
		93, 132, 189, 190	
		saupoudreurs à épices	
		426, 427	
		seau à champagne	
		199, 324-326	
		seau à glaçons/seau à glaçons	
		isothermique	
		206, 322, 334, 335, 350	
		seau à vin ou champagne	
		199	
		320-323, 326, 327	
		service à parmesan	
		418	
		set apéritif	
		107, 412-419	
		set de 2 bouchons à vide pour le vin	
		359	
		set pour le bar/cuillère à cocktail/tamis	
		cocktail/organisateur „bar caddy“	
		342-344, 350	
		set rolltop	
		151, 202, 237, 241	
		set rolltop/cloche à fromage	
		240	
		set sel et poivre	
		428	
		sets de tables/chemins de table	
		309	
		404-409, 438	
		shaker boston	
		340, 341	
		snack-hwwwolder	
		136, 137-139	
		sonnette	
		354	

# APS+

APS Plus – das multifunktionale Mix & Match Buffetsystem  
Designed by sieger design

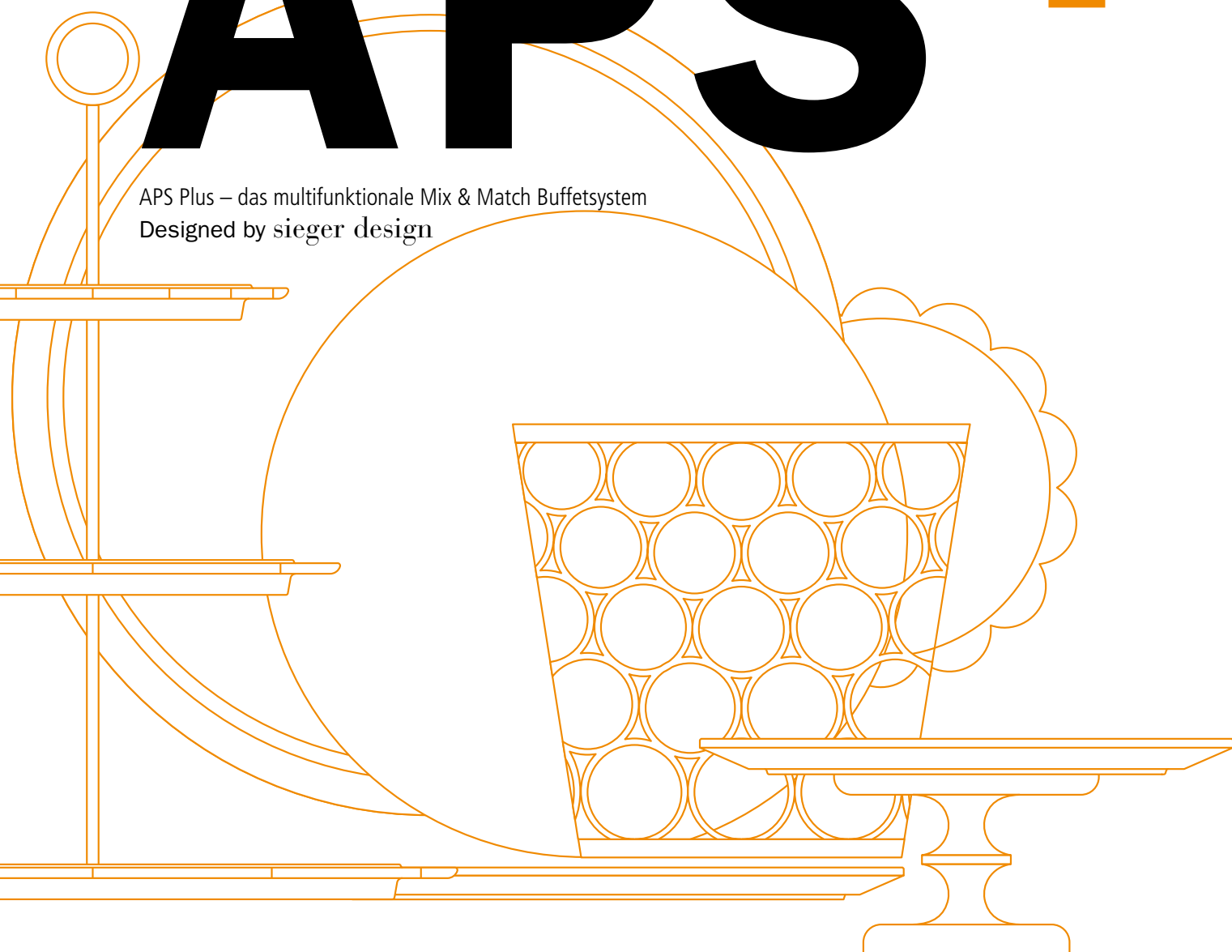

# Universal

Bowls  
S. 18

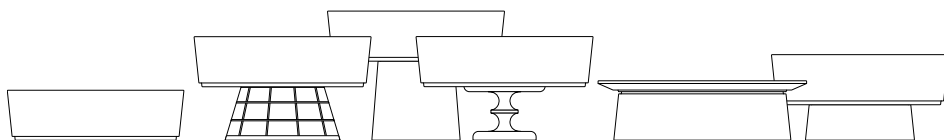

# Antipasti

Flat Bowls  
S. 22

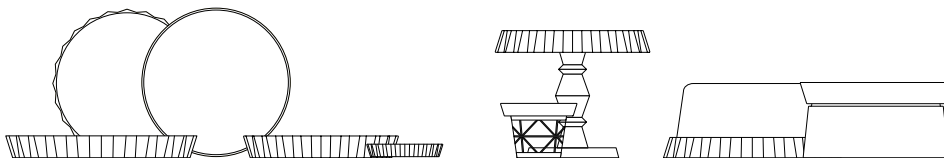

# Bakery

Platters & Etagère  
S. 24

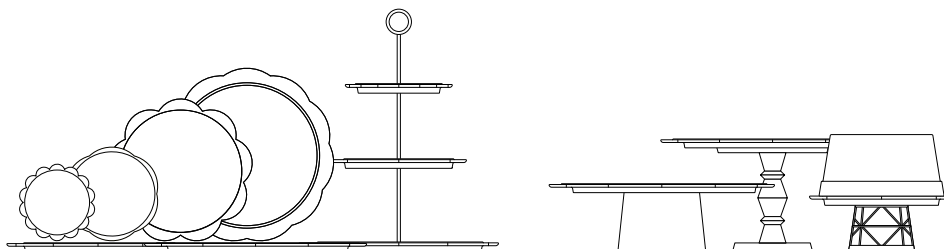

# Lotus

Bowls & Platters  
S. 26

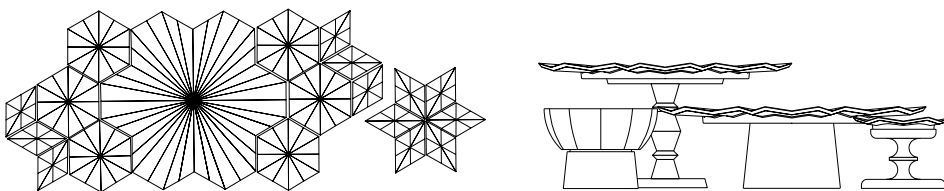

# Wood

Platters & Stands  
S. 29

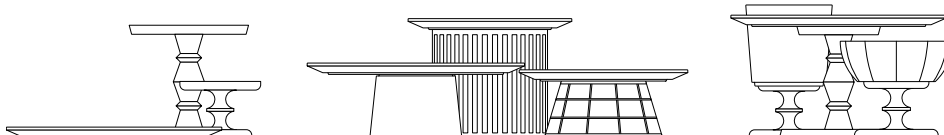

# Tiles

Platters & Tray  
S. 30

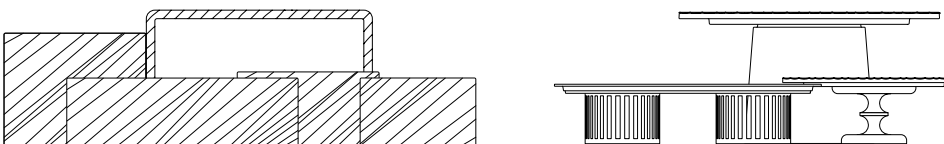

# Baskets

Baskets & Riser  
S. 32

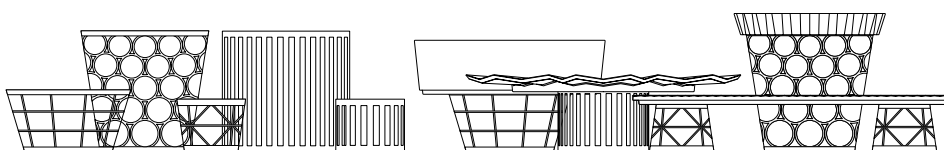



# Buffetwelten mit Mehrwert – wunderschön systematisch

## APS+ Ein System, viele Gesichter

Immer wieder neu, immer wieder anders – APS+ ermöglicht verschiedene Stilwelten und eröffnet nahezu unendlich viele Möglichkeiten, Speisen zu inszenieren. Dafür lassen sich die einzelnen Teile des Systems multifunktional mit-, in- und aufeinander kombinieren. So kann eine Schale auch Sockel für andere Teile sein, in unterschiedlichen Höhen wird Kulinarisches präsentiert und anschließend praktisch verwahrt. Mit dem Mix an Formen, Materialien und Oberflächen wird auch Fingerfood abwechslungsreich in Szene gesetzt. Damit entspricht das von sieger design gestaltete Buffetsystem den modernen Anforderungen der heutigen Gastronomie.

## APS+ one system, many faces

Always new, always different - APS+ enables a variety of styles and opens up almost endless options for presenting your dishes. The individual items in the multifunctional range can be combined with, in and on each other. Bowls can double as bases for other items, culinary creations can be presented at different heights and afterwards it can all be stored practically. The mix of forms, materials and surfaces also allows highly varied presentation of finger food, ensuring that the buffet range designed by sieger design meets the cutting-edge needs of modern gastronomy.

## APS+ un sistema, muchas cara

Cada vez nuevo, cada vez diferente: APS+ permite crear diferentes estilos y abre infinitas posibilidades para la puesta en escena de sus platos. Las piezas individuales del sistema se pueden combinar de forma multifuncional. Así, un cuenco puede servir de base para otras piezas, para presentar creaciones culinarias a diferentes alturas y almacenarlas después de una manera muy práctica. La mezcla de formas, materiales y superficies también permite presentar aperitivos de formas muy variadas. De este modo, el sistema de bufé diseñado por sieger design responde a las necesidades modernas de la gastronomía actual.

## APS+ un système, de nombreux visages

Il se renouvelle sans cesse, adoptant des styles divers et offrant d'infinies possibilités de présenter vos mets. Il vous suffit de jouer sur le caractère multifonctionnel de ses éléments en les combinant, les imbriquant et les empilant. Un récipient peut ainsi devenir le socle d'autres pièces pour une présentation sur différentes hauteurs, puis redevenir un récipient pratique pour son rangement. Le mélange des formes, matériaux et finitions est aussi propice à une présentation variée d'amuse-bouches. Le système signé sieger design répond ainsi aux exigences de la restauration d'aujourd'hui.

### Funktionen / functions / funciones / functions

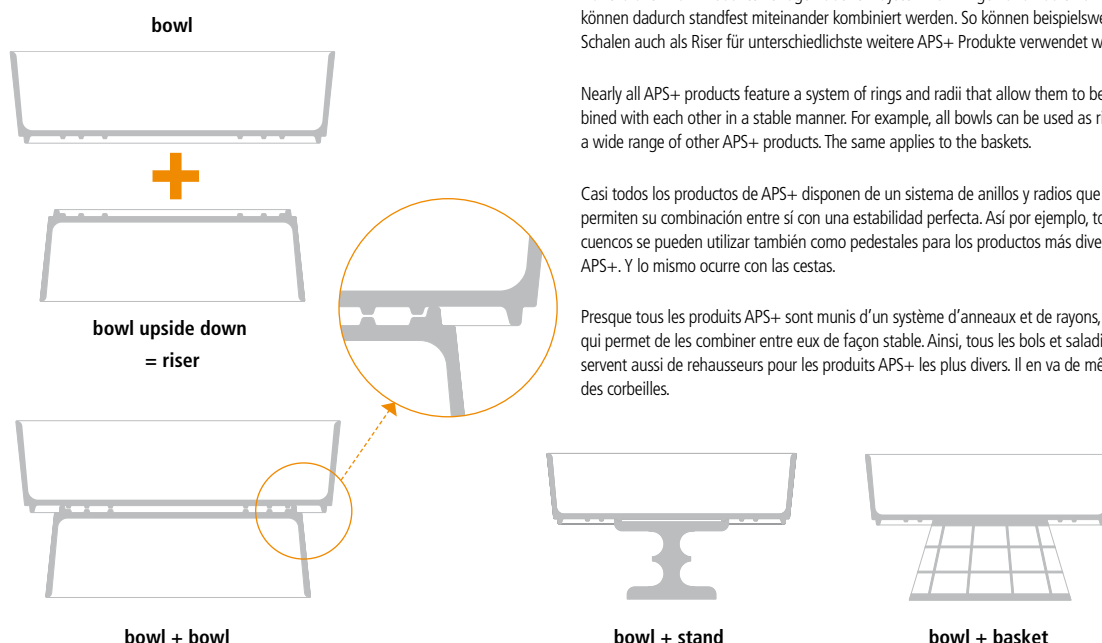

Nahezu alle APS+ Produkte verfügen über ein System von Ringen und Radien und können dadurch standfest miteinander kombiniert werden. So können beispielsweise alle Schalen auch als Riser für unterschiedlichste weitere APS+ Produkte verwendet werden.

Nearly all APS+ products feature a system of rings and radii that allow them to be combined with each other in a stable manner. For example, all bowls can be used as risers for a wide range of other APS+ products. The same applies to the baskets.

Casi todos los productos de APS+ disponen de un sistema de anillos y radios que permiten su combinación entre sí con una estabilidad perfecta. Así por ejemplo, todos los cuencos se pueden utilizar también como pedestales para los productos más diversos de APS+. Y lo mismo ocurre con las cestas.

Presque tous les produits APS+ sont munis d'un système d'anneaux et de rayons, ce qui permet de les combiner entre eux de façon stable. Ainsi, tous les bols et saladiers servent aussi de rehausseurs pour les produits APS+ les plus divers. Il en va de même des corbeilles.

+ Kompatibilität / compatibility / combinación / compatibilité

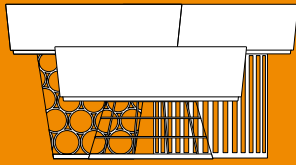

Baskets  
risers

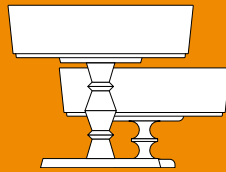

Wood  
risers

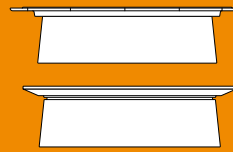

Bakery / Wood  
plates

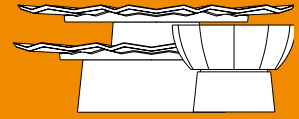

Lotus  
bowls / plates



weiß; innen glänzend, außen matt  
white; glossy on the inside, matt on the outside  
blanco; interior brillante, exterior mate  
blanc; intérieur brillant, extérieur mat



Holzdekor Ahorn & Farbe  
maple wood decor & colour  
textura de madera arce & color  
aspect érable & couleur



bicolor  
bicolour  
bicolor  
bicolore



Holzdekor Eiche dunkel & Farbe  
oak wood decor & colour  
textura de madera roble oscuro  
aspect chêne foncé & couleur



bicolor  
bicolour  
bicolor  
bicolore

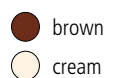

**Schale, rund „UNIVERSAL“**  
**bowl, round**  
**cuenco, redondo**  
**bol rond**



	□ cm	↑ cm	ltr.		€
15100 0	Ø 6,5	6	0,15	○	2,00
15101 7	Ø 9	4	0,15	○	2,20
15102 4	Ø 13	7	0,6	○	5,50
15103 1	Ø 16	12	1,5	○	12,00
15104 8	Ø 16	15	2,5	○	14,00
15105 5	Ø 20	7	1,5	○	14,00
15106 2	Ø 24	9	2,7	○	18,00
15107 9	Ø 26,5	9	3	○	22,00
15108 6	Ø 32,5	9	4	○	30,00

**Schale, quadratisch „UNIVERSAL“**  
**bowl, square**  
**bol cuadrado**  
**plat creux carré**



15110

	□ cm	↑ cm	ltr.		€
15110 9	6,5 x 6,5	6	0,15	○	2,20
15111 6	9 x 9	4	0,15	○	2,50
15112 3	13 x 13	7	0,6	○	6,00
15113 0	20 x 20	7	1,5	○	15,00
15114 7	24 x 24	9	3,5	○	22,00
15115 4	26,5 x 26,5	9	4	○	25,00



stapelbar  
stackable



15111



15115

**Schale, rechteckig „UNIVERSAL“**  
**bowl, rectangular**  
**cuenco, rectangular**  
**plat creux rectangulaire**



GN1/4  
2 Höhen / 2 heights

15117

	□ cm	↑ cm	GN	ltr.		€
15116 1	26,5 x 16,2	7	1/4	1,5	○	15,00
15117 8	26,5 x 16,2	9	1/4	2,5	○	17,00



15210



15230

**Schale, rund „UNIVERSAL“**  
**bowl, round**  
**cuenco, redondo**  
**bol rond**



Holzdekor Ahorn & Farbe  
 maple wood decor & colour  
 textura de madera arce & color  
 aspect érable & couleur

	cm	cm	ltr.		€
15210 6	Ø 13	7	0,6	● ○	7,40
15211 3	Ø 20	7	1,5	● ○	17,00
15212 0	Ø 24	9	2,7	● ○	22,00
15213 7	Ø 26,5	9	3	● ○	27,00
15214 4	Ø 32,5	9	4	● ○	39,00
15230 4	Ø 20	7	1,5	● ●	17,00
15231 1	Ø 32,5	9	4	● ●	39,00

**Schale, quadratisch „UNIVERSAL“**  
**bowl, square**  
**bol cuadrado**  
**plat creux carré**



Holzdekor Eiche dunkel & Farbe  
 oak wood decor & colour  
 textura de madera roble oscuro & color  
 aspect chêne foncé couleur



15216



15233

	cm	cm	ltr.		€
15215 1	13 x 13	7	0,6	● ○	8,50
15216 8	20 x 20	7	1,5	● ○	20,00
15217 5	24 x 24	9	3,5	● ○	30,00
15218 2	26,5 x 26,5	9	4	● ○	34,00
15232 8	20 x 20	7	1,5	● ●	20,00
15233 5	26,5 x 26,5	9	4	● ●	34,00

**Schale, rechteckig „UNIVERSAL“**  
**bowl, rectangular**  
**cuenco, rectangular**  
**plat creux rectangulaire**



Holzdekor Eiche dunkel & Farbe  
 oak wood decor & colour  
 textura de madera roble oscuro & color  
 aspect chêne foncé couleur



15219

**GN1/4**  
**2 Höhen / 2 hights**



15234

	cm	cm	GN	ltr.		€
15219 9	26,5 x 16,2	7	1/4	1,5	● ○	21,00
15220 5	26,5 x 16,2	9	1/4	2,5	● ○	24,00
15234 2	26,5 x 16,2	7	1/4	1,5	● ●	21,00
15235 9	26,5 x 16,2	9	1/4	2,5	● ●	24,00



15235

**Schale „UNIVERSAL“  
bowl  
cuenco  
bol**



15200



15204



15201



15205



15203



	cm	↑ cm	ltr.		€
15200 7	Ø 6,5	6	0,15	● ○	2,50
15201 4	Ø 9	4	0,15	● ○	2,80
15202 1	Ø 16	12	1,5	● ○	14,00
15203 8	Ø 16	15	2,5	● ○	17,00



	cm	↑ cm	ltr.		€
15204 5	6,5 x 6,5	6	0,15	● ○	2,90
15205 2	9 x 9	4	0,15	● ○	3,20

**Deckel „UNIVERSAL“  
cover  
tapa  
couverture seul**



glasklar, mit Löffelaussparung  
transparent, with notched for spoons  
plástico, con espacio para la cuchara  
transparent, avec encoche pour la cuillère



15340-15344



15345-15347



15348



	cm	↑ cm		€
15340 0	Ø 16	1,5	○ transparent	4,50
15341 7	Ø 20	1,5	○ transparent	5,00
15342 4	Ø 24	1,5	○ transparent	6,00
15343 1	Ø 26,5	1,5	○ transparent	6,80
15344 8	Ø 32,5	1,5	○ transparent	10,00



	cm	↑ cm		€
15345 5	20 x 20	1,5	○ transparent	5,60
15346 2	24 x 24	1,5	○ transparent	6,80
15347 9	26,5 x 26,5	1,5	○ transparent	8,00

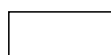

	cm	↑ cm	GN		€
15348 6	26,5 x 16,2	1,5	1/4	○ transparent	6,00



15232

+ Kompatibilität / compatibility / combinación / compatibilité

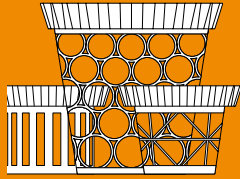

**Baskets**  
risers

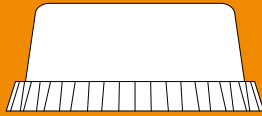

**Cover**  
seal

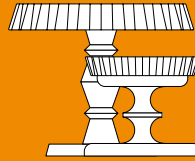

**Wood**  
risers

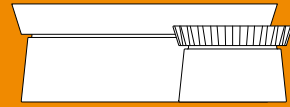

**Bowls**  
risers



15140



15141



15142

**Schale „PLISSEE“**  
bowl  
cuenco  
bol



	cm	cm		€
15140 6	Ø 14,5	2,5	○	4,50
15141 3	Ø 25	3,5	○	13,00
15142 0	Ø 35	4	○	24,00



15135

**Schale  
bowl  
cuenco  
bol**



	□ cm	↑ cm		€
15135 2	Ø 14,5	2,5	○	3,90
15136 9	Ø 25	3,5	○	9,90
15137 6	Ø 35	4	○	18,00

**3 Größen / 3 sizes**



15136



15137



15270

**Schale  
bowl  
cuenco  
bol**



Holzdekor Ahorn & Farbe  
maple wood decor & colour  
textura de madera arce & color  
aspect érable & couleur

**3 Größen / 3 sizes**



15271

	□ cm	↑ cm		€
15270 0	Ø 14,5	2,5	● ○	4,00
15271 7	Ø 25	3,5	● ○	11,50
15272 4	Ø 35	4	● ○	20,00

**3mm Materialstärke**



15351

**Frischhalte-Haube  
cover  
campana  
cloche bombée**



glasklar, Griff verchromt  
transparent, chrome knob  
transparente, asa cromada  
transparente, poignée chromée



06512

	□ cm	↑ cm	matches	€
15351 6	Ø 20,5	10	15141 15136 15271	12,00
06512 3	Ø 30	11,5	15142 15137 15272	5,90

+ Kompatibilität / compatibility / combinación / compatibilité

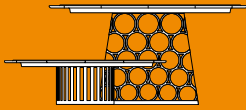

Baskets  
risers

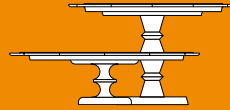

Wood  
risers

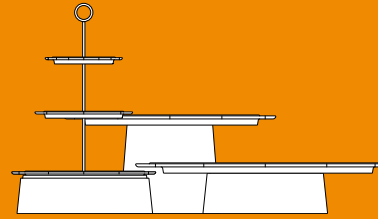

Universal  
risers





**Tablett „BAKERY“**  
tray  
bandeja  
plateau



	□ cm	↑ cm		€
15130 7	Ø 18,5	1,5	○	8,40
15131 4	Ø 23,5	1,5	○	13,00
15132 1	Ø 35	1,5	○	26,00
15133 8	Ø 42,5	1,5	○	39,00



15131

15132  
15133

**Etagère „BAKERY“**  
etagère  
expositor  
présentoir



	□ cm	↑ cm		€
15160 4	Ø 35/23,5/18,5	40	○	49,00



3mm Materialstärke



15350,  
15351

**Frischhalte-Haube**  
cover  
campana  
cloche bombée



glasklar, Griff verchromt, schwere stabile Ausführung  
transparent, chrome knob, heavy stable quality  
transparente, asa cromada, alta estabilidad  
transparente, anse chromée, très stable

	□ cm	↑ cm	matches		€
15350 9	Ø 16,5	10	15130	○ transparent	10,00
15351 6	Ø 20,5	10	15131	○ transparent	12,00
06512 3	Ø 30	11,5	15132	○ transparent	5,90
06517 8	Ø 33	12,5	15133	○ transparent	6,90



15133

Rolltop Cover

18388 9	Ø 38	20	15133	○ transparent	19,40
---------	------	----	-------	---------------	-------



15133

+ Kompatibilität / compatibility / combinación / compatibilité

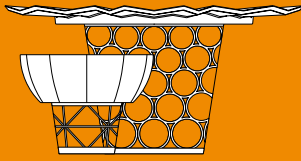

Baskets  
risers

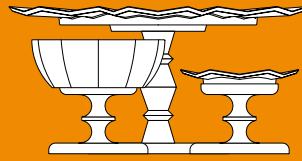

Wood  
risers

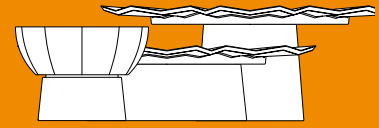

Universal  
risers





○ 15152

**Blattschale large „LOTUS“**  
**leaf large**  
**fuelle en forma de hoja**  
**plat feuille**



	cm	cm		€
15152 9	Ø 46,5	2,5	○ white	34,00
15257 1	Ø 46,5	2,5	● green	34,00
15263 2	Ø 46,5	2,5	● dark green	34,00



● 15257



● 15263



○ 15151

**Blattschale medium „LOTUS“**  
**leaf medium**  
**fuelle en forma de hoja**  
**plat feuille**



	cm	cm		€
15151 2	Ø 17,5	2,5	○ white	6,00
15259 5	Ø 17,5	2,5	● yellow green	6,00
15256 4	Ø 17,5	2,5	● green	6,00
15262 5	Ø 17,5	2,5	● dark green	6,00



● 15259



● 15256



● 15262



○ 15150

**Blattschale small „LOTUS“**  
**leaf small**  
**fuelle en forma de hoja**  
**plat feuille**



	cm	cm		€
15150 5	15 x 8,5	2,5	○ white	3,00
15258 8	15 x 8,5	2,5	● yellow green	3,00
15255 7	15 x 8,5	2,5	● green	3,00
15261 8	15 x 8,5	2,5	● dark green	3,00

● 15261



● 15255

● 15258

○ 15150

Schale Water Lily „LOTUS“  
leaf  
fuente en forma de hoja  
plat feuille



	cm	cm	ltr.		€
15165 9	Ø 8,5	4	0,1	○	2,90
15166 6	Ø 13	6	0,3	○	5,40
15167 3	Ø 20	7	1,25	○	13,50



15165  
0,1 ltr.



15166  
0,3 ltr.



15167  
1,25 ltr.

Schale Water Lily „LOTUS“  
leaf  
fuente en forma de hoja  
plat feuille



	cm	cm	ltr.		€
15206 9	Ø 8,5	4	0,1	●○	3,30
15207 6	Ø 13	6	0,3	●○	6,50
15208 3	Ø 20	7	1,25	●○	16,00

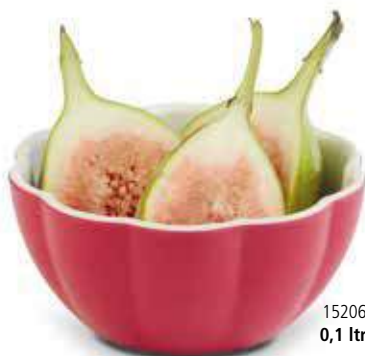

15206  
0,1 ltr.



15207  
0,3 ltr.



15208  
1,25 ltr.

+ Kompatibilität / compatibility / combinación / compatibilité



Universal  
bowls

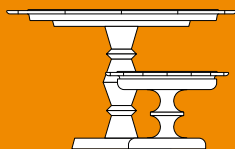

Tiles  
plates

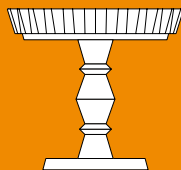

Antipasti  
flat bowls

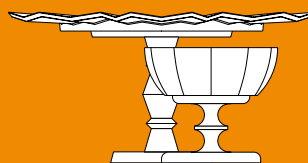

Lotus  
plates / bowls

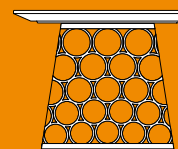

Baskets  
risers



15300



15303

### Tablett „WOOD“ tray bandeja plateau

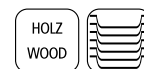

- Eiche dunkel oder ● Ahorn
- oak or ● maple
- roble oscuro o ● arce
- chêne foncé ou ● érable

	cm	cm		matches	€
15300	4	Ø 30	2	●	all stands, bowls 39,00
15301	1	Ø 30	2	●	all stands, bowls 39,00
15302	8	Ø 38,5	2	●	all stands, bowls 49,00
15303	5	Ø 38,5	2	●	all stands, bowls 49,00



15312



15311

### Ständer „WOOD“ stand soporte support



- Eiche dunkel oder ● Ahorn
- oak or ● maple
- roble oscuro o ● arce
- chêne foncé ou ● érable

	cm	cm		matches	€
15310	3	Ø 15/11,5	10,5	●	all plates, bowls 39,00
15311	0	Ø 15/11,5	10,5	●	all plates, bowls 39,00
15312	7	Ø 21/15	20	●	all plates, bowls 49,00
15313	4	Ø 21/15	20	●	all plates, bowls 49,00



06517

15303

15313



18388  
Rolltop Cover

### Frischhalte-Haube cover campana cloche



glasklar, schwere stabile Ausführung, stapelbar  
clear, heavy stable quality, stackable  
transparente, alta estabilidad, apilable  
transparente, très stable, empilable

	cm	cm		matches	€
06517	8	Ø 33	12,5	15302,15303	6,90
18388	9	Ø 38	20	15302,15303	19,40

+ Kompatibilität / compatibility / combinación / compatibilité

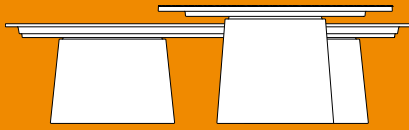

**Bowls**  
risers

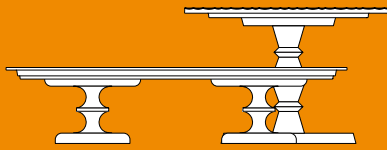

**Wood**  
risers

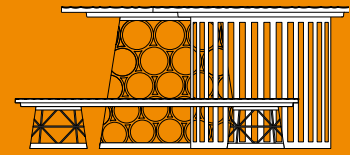

**Baskets**  
risers



Tablett „TILES“  
tray  
bandeja  
plateau



	☐ cm	↑ cm	GN		€
15120 8	53 x 32,5	2	1/1	○ white	29,90
15236 6	53 x 32,5	2	1/1	● black	29,90



**Tablett „TILES“  
tray  
bandeja  
plateau**



weiß / white / blanco / blanc

	□ cm	↑ cm	GN		€
15125 3	26,5 x 16,2	1,5	1/4	○	13,00
15126 0	35,5 x 17,6	1,5	1/3	○	17,00
15128 4	32,5 x 26,5	1,5	1/2	○	24,00
15127 7	53 x 16,2	1,5	2/4	○	24,00



**Tablett „TILES“  
tray  
bandeja  
plateau**



schwarz / black / negro / noir

	□ cm	↑ cm	GN		€
15250 2	26,5 x 16,2	1,5	1/4	●	13,00
15251 9	32,5 x 17,5	1,5	1/3	●	17,00
15253 3	32,5 x 26,5	1,5	1/2	●	24,00
15252 6	53,0 x 16,2	1,5	2/4	●	24,00



**Tablett „TILES“  
tray  
bandeja  
plateau**



Holzdekor Ahorn / maple wood decor / textura de madera arce / aspect érable

	□ cm	↑ cm	GN		€
15221 2	26,5 x 16,2	1,5	1/4	⊙	15,00
15222 9	32,5 x 17,6	1,5	1/3	⊙	19,00
15224 3	32,5 x 26,5	1,5	1/2	⊙	26,00
15223 6	53 x 16,2	1,5	2/4	⊙	26,00



**Tablett „TILES“  
tray  
bandeja  
plateau**



Holzdekor Eiche dunkel / oak wood decor / textura de madera / aspect chêne foncé

	□ cm	↑ cm	GN		€
15225 0	26,5 x 16,2	1,5	1/4	●	15,00
15226 7	32,5 x 17,5	1,5	1/3	●	19,00
15228 1	32,5 x 26,5	1,5	1/2	●	26,00
15227 4	53,0 x 16,2	1,5	2/4	●	26,00

+ Kompatibilität / compatibility / combinación / compatibilité

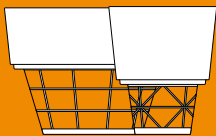

Universal  
bowls

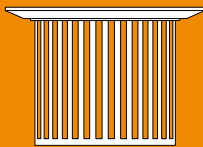

Wood  
plates

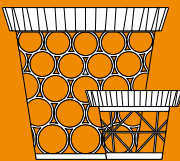

Antipasti  
flat bowls

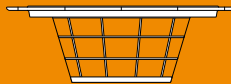

Tiles  
plates

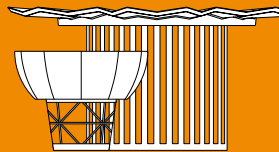

Lotus  
plates







**Korb/Ständer**  
**basket/riser**  
**cestas/soporte**  
**corbeilles/support**



schwarz / black / negro / noir

	□ cm	↑ cm		€
15326 4	Ø 21/15	21	● black	24,00



**Korb/Ständer**  
**basket/riser**  
**cestas/soporte**  
**corbeilles/support**



Metall / metal / metálico / métal

	□ cm	↑ cm		€
15321 9	Ø 21/15	11	● chrome	24,00
15325 7	Ø 21/15	11	● gold brushed	24,00
15323 3	Ø 21/15	11	● copper	24,00



**Korb/Ständer**  
**basket/riser**  
**cestas/soporte**  
**corbeilles/support**



Metall / metal / metálico / métal

	□ cm	↑ cm		€
15320 2	Ø 10,5/8	8	● chrome	14,00
15324 0	Ø 10,5/8	8	● gold brushed	14,00
15322 6	Ø 10,5/8	8	● copper	14,00



**Korb/Ständer**  
**basket/riser**  
**cestas/soporte**  
**corbeilles/support**



Chrom poliert / polished chrome / color plata brillante / chrome poli

	□ cm	↑ cm		€
15331 8	Ø 15	10,5	● chrome	24,00
15332 5	Ø 21	20	● chrome	39,00



**Korb/Ständer**  
**basket/riser**  
**cestas/soporte**  
**corbeilles/support**



Gold, gebürstet / brushed gold / dorado cepillado / doré brossé

	□ cm	↑ cm		€
15334 9	Ø 15	10,5	● gold brushed	24,00
15335 6	Ø 21	20	● gold brushed	39,00

designed by sieger design



# ASIA+ - die neue, unendlich kreative Vielfalt!

## Funktionen

Nahezu alle ASIA+ Produkte verfügen über ein System von Ringen und Radien und können dadurch stand- und rutschfest miteinander kombiniert werden. So können beispielsweise alle Schalen auch als Riser / Aufsteller für unterschiedlichste weitere ASIA+ Produkte verwendet werden.

## Functions

Nearly all ASIA+ products feature a system of rings and radii that allow them to be combined with each other in a stable manner. For example, all bowls can be used as risers for a wide range of other ASIA+ products. The same applies to the baskets.

## Funciones

Casi todos los productos de ASIA+ disponen de un sistema de anillos y radios que permiten su combinación entre sí con una estabilidad perfecta. Así por ejemplo, todos los cuencos se pueden utilizar también como pedestales para los productos más diversos de ASIA+. Y lo mismo ocurre con las cestas.

## Functions

Presque tous les produits ASIA+ sont munis d'un système d'anneaux et de rayons, ce qui permet de les combiner entre eux de façon stable. Ainsi, tous les bols et saladiers servent aussi de rehausseurs pour les produits ASIA+ les plus divers. Il en va de même des corbeilles.



Tablett  
tray

Schale  
bowl



Unterseite Schale  
bottom bowl





NEW

Schale „ASIA PLUS“  
bowl  
cuenco  
bol



	cm	cm	litr.		€
15400	1	Ø 7,5	3,5	0,06	2,00
15401	8	Ø 9,5	4,5	0,13	3,00
15402	5	Ø 13	5,5	0,35	5,00
15403	2	Ø 16	7	0,60	7,00
15404	9	Ø 20	8	1,10	11,40
15405	6	Ø 24	9,5	2,20	17,00
15406	3	Ø 26,5	11	3,00	22,00
15407	0	Ø 32,5	12,5	5,40	30,00

15408	7	Ø 7,5	3,5	0,06	2,00
15409	4	Ø 9,5	4,5	0,13	3,00
15410	0	Ø 13	5,5	0,35	5,00
15411	7	Ø 16	7	0,60	7,00
15412	4	Ø 20	8	1,10	11,40
15413	1	Ø 24	9,5	2,20	17,00
15414	8	Ø 26,5	11	3,00	22,00
15415	5	Ø 32,5	12,5	5,40	30,00

15416	2	Ø 7,5	3,5	0,06	2,00
15417	9	Ø 9,5	4,5	0,13	3,00
15418	6	Ø 13	5,5	0,35	5,00
15419	3	Ø 16	7	0,60	7,00
15420	9	Ø 20	8	1,10	11,40
15421	6	Ø 24	9,5	2,20	17,00
15422	3	Ø 26,5	11	3,00	22,00
15423	0	Ø 32,5	12,5	5,40	30,00

	cm	cm	passend für / suitable for	€	
15340	0	Ø 16	1,5	15403 / 15411 / 15419	4,50
15341	7	Ø 20	1,5	15404 / 15412 / 15420	5,00
15342	4	Ø 24	1,5	15405 / 15413 / 15421	6,00
15343	1	Ø 26,5	1,5	15406 / 15414 / 15422	6,80
15344	8	Ø 32,5	1,5	15407 / 15415 / 15423	10,00



**NEW**

**Teller „ASIA PLUS“**  
plate  
plato  
assiette



	cm	↑ cm		€	
15424	7	Ø 11	2	○	2,60
15425	4	Ø 16	2	○	4,60
15426	1	Ø 19,5	2	○	6,00
15427	8	Ø 24	2	○	9,00
15428	5	Ø 28	2	○	12,40



15429	2	Ø 11	2	●	2,60
15430	8	Ø 16	2	●	4,60
15431	5	Ø 19,5	2	●	6,00
15432	2	Ø 24	2	●	9,00
15433	9	Ø 28	2	●	12,40



15434	6	Ø 11	2	●	2,60
15435	3	Ø 16	2	●	4,60
15436	0	Ø 19,5	2	●	6,00
15437	7	Ø 24	2	●	9,00
15438	4	Ø 28	2	●	12,40



**NEW**

**Bento Box „ASIA PLUS“**



	cm	↑ cm	ltr.		€
15461	2 Ø 7,5	3	0,04	○	1,90
15462	9 Ø 7,5	6,5	0,13	○	2,60
15463	6 Ø 15,5	3	0,13	○	4,00
15464	3 Ø 15,5	6,5	0,60	○	6,00
15465	0 Ø 23	3	0,40	○	9,40
15466	7 Ø 23	6,5	1,60	○	11,40



	cm	↑ cm	ltr.		€
15467	4 Ø 7,5	3	0,04	●	2,70
15468	1 Ø 7,5	6,5	0,13	●	3,90
15469	8 Ø 15,5	3	0,13	●	6,90
15470	4 Ø 15,5	6,5	0,60	●	9,80
15471	1 Ø 23	3	0,40	●	14,90
15472	8 Ø 23	6,5	1,60	●	17,90



	cm	↑ cm	ltr.		€
15473	5 7,5 x 7,5	3	0,05	○	2,00
15474	2 7,5 x 7,5	6,5	0,16	○	2,80
15479	7 15,5 x 15,5	3	0,19	○	5,20
15480	3 15,5 x 15,5	6,5	0,85	○	7,50
15481	0 23 x 23	3	0,45	○	10,00
15482	7 23 x 23	6,5	2,00	○	22,00



	cm	↑ cm	ltr.		€
15485	8 7,5 x 7,5	3	0,05	●	3,40
15486	5 7,5 x 7,5	6,5	0,16	●	4,20
15491	9 15,5 x 15,5	3	0,19	●	9,00
15492	6 15,5 x 15,5	6,5	0,85	●	15,80
15493	3 23 x 23	3	0,45	●	17,00
15494	0 23 x 23	6,5	2,00	●	37,00



	cm	↑ cm	ltr.		€
15475	9 15,5 x 7,5	3	0,10	○	3,40
15476	6 15,5 x 7,5	6,5	0,40	○	4,60
15477	3 15,5 x 9,5	3	0,15	○	3,60
15478	0 15,5 x 9,5	6,5	0,50	○	5,40
15483	4 25 x 15,5	3	0,30	○	8,00
15484	1 25 x 15,5	6,5	1,40	○	11,00



	cm	↑ cm	ltr.		€
15487	2 15,5 x 7,5	3	0,10	●	6,40
15488	9 15,5 x 7,5	6,5	0,40	●	8,00
15489	6 15,5 x 9,5	3	0,15	●	7,20
15490	2 15,5 x 9,5	6,5	0,50	●	9,40
15495	7 25 x 15,5	3	0,30	●	11,60
15496	4 25 x 15,5	6,5	1,40	●	14,40

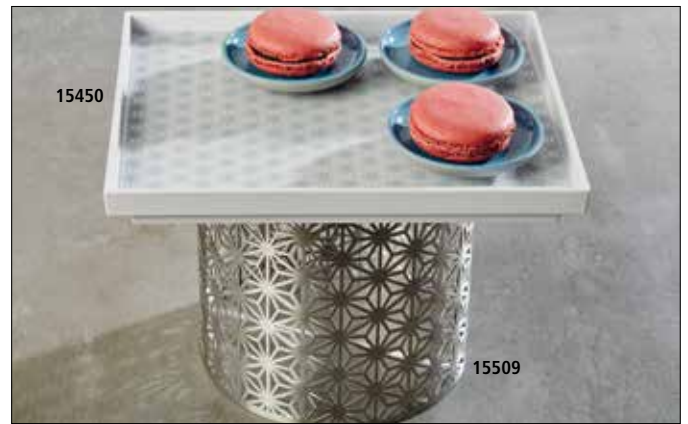

NEW



Tablett „ASIA PLUS“  
tray  
bandeja  
plat



	cm	↑ cm	GN		€
15449 0	53,0 x 32,5	3	1/1	○	34,00
15450 6	32,5 x 26,5	3	1/2	○	19,00
15451 3	32,5 x 17,6	3	1/3	○	14,00
15452 0	26,5 x 16,2	3	1/4	○	11,00
15453 7	35,4 x 32,5	3	2/3	○	24,00
15454 4	53,0 x 16,2	3	2/4	○	22,00
15455 1	53,0 x 32,5	3	1/1	●	44,00
15456 8	32,5 x 26,5	3	1/2	●	25,00
15457 5	32,5 x 17,6	3	1/3	●	18,00
15458 2	26,5 x 16,2	3	1/4	●	15,00
15459 9	35,4 x 32,5	3	2/3	●	31,00
15460 5	53,0 x 16,2	3	2/4	●	28,00

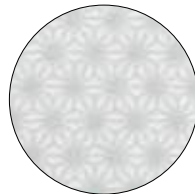
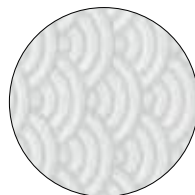
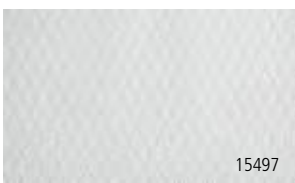

Antirutschmatte „ASIA PLUS“  
non slip mat  
esterilla antideslizante  
tapis antidérapantes

SILIKON  
SILICON

	cm		passend zu / suitable for	€
15497 1	51,0 x 31,0	●	15449, 15455	12,00
15499 5	31,0 x 25,5	●	15450, 15456	7,40
15498 8	51,0 x 31,0	●	15449, 15455	12,00
15500 8	31,0 x 25,5	●	15450, 15456	7,40





**Tablett „ASIA PLUS“  
tray  
bandeja  
plat**

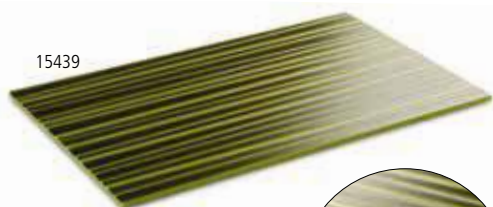

**Bambusblattstruktur  
bamboo leaf structure  
estructura hoja de bambú  
structure feuille de bambou**

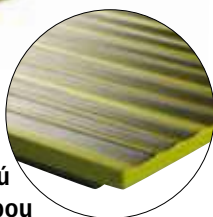

**Reiskornstruktur  
rice grain structure  
estructura grano de arroz  
structure grain de riz**

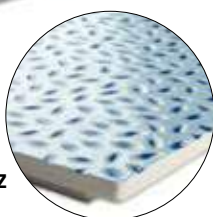

	☐ cm	↑ cm	GN		€
15439	1	53,0 x 32,5	1,5	1/1	44,00
15440	7	32,5 x 26,5	1,5	1/2	25,00
15441	4	32,5 x 17,6	1,5	1/3	20,00
15442	1	26,5 x 16,2	1,5	1/4	16,00
15443	8	53,0 x 16,2	1,5	2/4	28,00
15444	5	53,0 x 32,5	1,5	1/1	44,00
15445	2	32,5 x 26,5	1,5	1/2	25,00
15446	9	32,5 x 17,6	1,5	1/3	20,00
15447	6	26,5 x 16,2	1,5	1/4	16,00
15448	3	53,0 x 16,2	1,5	2/4	28,00

GN 1/1	GN 1/2	GN 1/4	GN 2/4
	GN 1/2	GN 1/4	
GN 1/3	GN 1/3	GN 1/3	



NEW

**Buffetständer / -korb „ASIA PLUS“**  
**buffet stand / basket**  
**soporte para bufé / cestas**  
**présentoir buffet / corbeilles**

EDELSTAHL  
 STAINLESS  
 INOX

mattiert  
 satin polished finish  
 acabado efecto satinado  
 fini mat effet satin



	☐ cm	↑ cm			€
15507 7	Ø 15	10,5	Edelstahl / stainless steel	mattiert	44,00
15510 7	Ø 15	10,5		● black coated	44,00
15508 4	Ø 21	10,5	Edelstahl / stainless steel	mattiert	59,00
15511 4	Ø 21	10,5		● black coated	59,00
15509 1	Ø 21	20	Edelstahl / stainless steel	mattiert	79,00
15512 1	Ø 21	20		● black coated	79,00





**NEW**

**Buffetständer „ASIA PLUS“**  
buffet stand  
soporte para bufé  
présentoir buffet

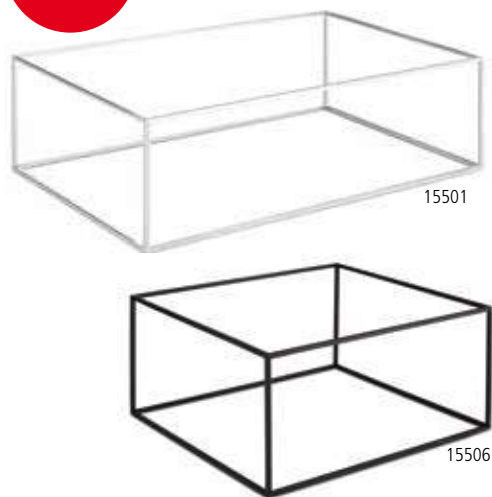

	cm	GN		€
15501 5	53,0 x 32,5 / 53,0 x 16,2	1/1 / 2/4	verchromt / chromed	22,00
15502 2	32,5 x 26,5 / 26,5 x 16,2	1/2 / 1/4	verchromt / chromed	14,40
15503 9	32,5 x 17,5 / 35,4 x 32,5	1/3 / 2/3	verchromt / chromed	18,00
15504 6	53,0 x 32,5 / 53,0 x 16,2	1/1 / 2/4	● black coated	18,00
15505 3	32,5 x 26,5 / 26,5 x 16,2	1/2 / 1/4	● black coated	11,20
15506 0	32,5 x 17,5 / 35,4 x 32,5	1/3 / 2/3	● black coated	14,40

**Auf der kurzen und der langen Seite aufstellbar!**  
**Can stay on the short or long side!**  
**Se puede colocar por la parte corta o larga!**  
**Se peut installer sur le côté court ou long!**

**NEW**

**Buffetständer „ASIA PLUS“**  
buffet stand  
soporte para bufé  
présentoir buffet



	cm	↑ cm		€
15513 8	Ø 20,5 / 16,5	20	poliert / polished	15,00
15514 5	Ø 20,5 / 16,5	20	● black coated	14,00



Servierartikel aus Melamin  
serving items melamine  
artículos de servicio en melamina  
pièces de service en mélamine

# STONE ART



84524  
Ø 12,0 cm

84523  
Ø 8,0 cm

84509  
Ø 15,5 cm

84517  
33,0 x 32,5 cm

84528  
28,5 x 21,0 cm

84526  
23,0 x 19,0 cm

84529  
19,0 x 19,0 cm

**NEW**

Teller „STONE ART“  
plate  
plato  
assiette



84510  
Ø 19,0 cm



84515  
Ø 24,5 cm



84511  
Ø 25,0 cm



84512  
Ø 30,0 cm

	cm	cm		€
84510 7	Ø 19,0	2,0	flacher Teller / flat plate	6,60
84511 4	Ø 25,0	2,0	flacher Teller / flat plate	11,00
84512 1	Ø 30,0	2,0	flacher Teller / flat plate	15,00
84515 2	Ø 24,5	3,5	tiefer Teller / deep plate	12,00



84526  
23,0 x 19,0 cm

84517  
33,0 x 32,5 cm

84529  
19,0 x 19,0 cm

84528  
28,0 x 21,0 cm

84524  
Ø 12,0 cm

84509  
Ø 15,5 cm

84523  
Ø 8,0 cm

**NEW**

**Schale „STONE ART“**  
bowl  
cuenco  
bol



84509  
Ø 15,5 cm



84514  
Ø 20,5 cm

	cm	↑ cm	ltr.	€
84509 1	Ø 15,5	2,5	0,15	4,90
84514 5	Ø 20,0	4,5	0,60	8,90

**NEW**

**Teller „STONE ART“**  
plate  
plato  
assiette



	cm	↑ cm	€
84517 6	33,0 x 32,5	3,0	22,00

**NEW**

Schale „STONE ART“  
bowl  
cuenco  
bol



84523  
Ø 8,0 cm



84524  
Ø 12,0 cm



84525  
Ø 15,0 cm

	cm	↑ cm	ltr.	€
84523 7	Ø 8,0	3,0	0,07	2,00
84524 4	Ø 12,0	6,0	0,3	4,20
84525 1	Ø 15,0	7,5	0,6	5,40

**NEW**

Schale „STONE ART“  
bowl  
cuenco  
bol



84526  
23,0 x 19,0 cm



84528  
28,5 x 21,0 cm

	cm	↑ cm	ltr.	€
84526 8	23,0 x 19,0	6,5	0,6	10,00
84528 2	28,5 x 21,0	7,5	1,2	16,00

**NEW**

Schale „STONE ART“  
bowl  
cuenco  
bol



84529  
19,0 x 19,0 cm



84530  
24,0 x 24,0 cm

	cm	↑ cm	ltr.	€
84529 9	19,0 x 19,0	6,0	0,5	11,00
84530 5	24,0 x 24,0	6,5	1,1	16,00





**NEW**

mit Antirutsch-Füßchen  
non-slip feet  
con pies antideslizantes  
avec pieds antidérapants



**Tablett „STONE ART“  
tray  
bandeja  
plat**



	cm	↑ cm	GN	€
84519 0	53,0 x 32,5	1,5	1/1	42,00
84520 6	32,5 x 26,5	1,5	1/2	22,00
84521 3	32,5 x 17,6	1,5	1/3	16,00
84522 0	53,0 x 16,2	1,5	2/4	24,00



# GLAMOUR



Schalen und Tablett in elegant matt-schwarz, mit glänzenden Sprenkeln, „Hingucker“ für Tisch und Buffet

Bowls and trays in elegant matte black color with glossy spots, an eye-catcher for table and buffet

Cuencos y bandejas en color negro mate elegante con una superficie brillante con salpicaduras, una atracción para su mesa y bufé

Bols et plateaux en couleur noir mat élégant avec une surface brillante mouchetée, point de mire pour la table et le buffet

**NEW**



Schale „GLAMOUR“  
bowl  
cuenco  
bol



	cm	cm	ltr.	€
84365 3	Ø 8	3	0,05	1,40
84366 0	Ø 12	5	0,35	1,80
84367 7	Ø 15	8	0,70	4,40

**NEW**



Schale „GLAMOUR“  
bowl  
cuenco  
bol



	cm	cm	ltr.	€
84373 8	19,5 x 9	5	0,2	2,90
84374 5	21,5 x 14,5	4,5	0,3	3,90

**NEW**



**Tablett „GLAMOUR“  
tray  
bandeja  
plat**



	▣ cm	↑ cm	€
84375 2	26,5 x 8,5	2	2,40
84376 9	33,5 x 11	3	4,00

**NEW**



**Tablett „GLAMOUR“  
tray  
bandeja  
plat**



	▣ cm	↑ cm	€
84377 6	22 x 12	3	3,20
84378 3	37 x 11	2,5	9,00

**NEW**



**Tablett „GLAMOUR“  
tray  
bandeja  
plat**



	▣ cm	↑ cm	€
84379 0	30 x 11	3	4,90

**NEW**



**Tablett „GLAMOUR“  
tray  
bandeja  
plat**



	▣ cm	↑ cm	€
84380 6	25 x 15,5	1,5	2,90
84381 3	30,5 x 19	1,5	4,40

# LAGOON



Servierartikel mit kupferfarbenem Rand. Schlicht und zeitlos. Ideal für den Einsatz im Außenbereich (Pool, Spa, etc.).

Serving items with copper-colored border. Simple and timeless. Ideal for outdoor use (pool, spa, etc.).

Artículos de servicio con borde de color cobre. Simple e intemporal. Ideal para uso al aire libre (piscina, spa, etc.).

Pièces de service avec bord couleur cuivre. Simple et intemporel. Idéal pour une utilisation à l'extérieur (piscine, spa, etc.).

**NEW**

4 Größen / 4 sizes



84540  
Ø 20 cm



84543  
Ø 22,5 cm

Teller „LAGOON“  
tray  
bandeja  
plateau



	□ cm	↑ cm		€
84540 4	Ø 20,0	2,5	flacher Teller / flat plate	3,90
84541 1	Ø 22,5	2,5	flacher Teller / flat plate	4,90
84543 5	Ø 22,5	3,0	tiefer Teller / deep plate	4,20
84542 8	Ø 28,0	3,0	flacher Teller / flat plate	7,40

**NEW**

Teller „LAGOON“  
tray  
bandeja  
plateau



	□ cm	↑ cm		€
84544 2	24 x 24	2,5		6,90

**NEW**



**Tablett „LAGOON“  
tray  
bandeja  
plat**



	□ cm	↑ cm	€
84545 9	21,5 x 14,5	2	3,40
84546 6	24,5 x 16,5	2	4,90

**NEW**



**Schale „LAGOON“  
bowl  
cuenco  
bol**



	□ cm	↑ cm	ltr.	€
84551 0	Ø 9,5	4,5	0,1	1,90
84552 7	14,5 x 14,5	7,0	0,6	3,90

**NEW**



**Schale „LAGOON“  
bowl  
cuenco  
bol**



	□ cm	↑ cm	ltr.	€
84553 4	19 x 19	9	1,5	18,00
84554 1	25 x 25	12	3,8	29,00

**Einzelteile / spare parts / piezas sueltas / pièces détachées**

Deckel „PURE“, mit Löffelaussparung / cover, with notched for spoons  
tapa, con espacio para la cuchara / couvercle, avec encoche pour la louche

	□ cm	↑ cm	passend für / suitable for	€
83600 6	19 x 19	1,5	84553	8,00
83601 3	25 x 25	1,5	84554	10,50

**NEW**



**Tasse / Untertasse „LAGOON“  
cup / saucer  
taza / platillo  
tasse / soucoup**



	□ cm	↑ cm	ltr.	€
84550 3	Ø 8	6	0,17	Kaffeetasse / cup 3,00
84549 7	Ø 14	2	-	Kaffeuntertasse / saucer 2,40

# CROCKER



Servier- und Buffetartikel in Tonoptik, brauner Rand. Die Oberfläche ist innen und außen fein-matt, fühlt sich an wie 'Ton'.

Serving and buffet items, an imitation of clay, with a brown border. The surface is inside and outside fine-matt. Feels like real clay.

Artículos de servicio y bufé, imitación barro y con borde marrón. La superficie de dentro y de fuera es de deslustre fino. Parece barro natural.

Pièces de service et pour le buffet imitation argile avec bord marron. La surface est à l'intérieur et à l'extérieur bien-matte. Paraît argile naturelle.

**NEW**

## Teller „CROCKER“ tray bandeja plateau



84575  
Ø 20,5 cm



84576  
Ø 20,5 cm

	□ cm	↑ cm	ltr.		€
84575 6	Ø 20,5	3	0,50	○	5,40
84576 3	Ø 20,5	3	0,50	●	5,40

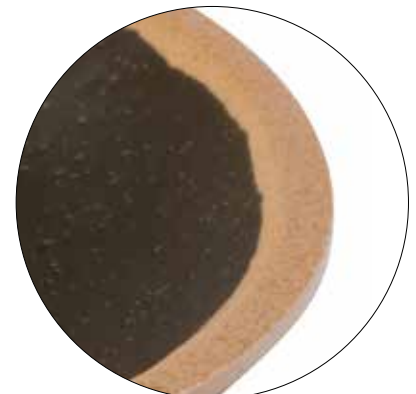

**NEW**



84567  
14,0 x 13,0 cm



84568  
14,0 x 13,0 cm

perfekt für Fingerfood  
perfect for fingerfood

**Teller „CROCKER“  
tray  
bandeja  
plateau**



	□ cm	↑ cm		€
84567 1	14 x 13	2,5	○	3,00
84568 8	14 x 13	2,5	●	3,00

**NEW**



84570  
Ø 12,5 cm



84571  
Ø 16,0 cm



84574  
Ø 16,5 cm



84577  
Ø 21,0 cm

**Schale „CROCKER“  
bowl  
cuenco  
bol**



	□ cm	↑ cm	litr.		€
84569 5	Ø 12,5	6	0,37	○	3,20
84570 1	Ø 12,5	6	0,37	●	3,20
84571 8	Ø 16,0	7	0,70	○	5,40
84572 5	Ø 16,0	7	0,70	●	5,40
84573 2	Ø 16,5	4	0,50	○	5,20
84574 9	Ø 16,5	4	0,50	●	5,20
84577 0	Ø 21,0	8	1,45	○	9,40
84578 7	Ø 21,0	8	1,45	●	9,40

**NEW**



84580  
30,5 x 10,0 cm



84581  
42,0 x 14,0 cm

**Blattschale „CROCKER“  
leaf  
fuente en forma de hoja  
plat feuille**



	□ cm	↑ cm	litr.		€
84579 4	30,5 x 10,0	7,5	0,17	○	6,00
84580 0	30,5 x 10,0	7,5	0,17	●	6,00
84581 7	42,0 x 14,0	9,5	0,65	○	14,00
84582 4	42,0 x 14,0	9,5	0,65	●	14,00

# FRIDA



einfache klare Formsprache - Scandinavian Design, innen und außen ist die Oberfläche matt, innen Holzoptik, außen uni-farben

simple and clear design – scandinavian design, the surface inside and outside is matt, interior is wooden finish, outside is plain colored

estilo sencillo y claro – diseño escandinavo, la superficie de dentro y de fuera es mate, el interior imitación madera y el exterior de un solo color

style simple et clair - conception scandinave, la surface est pâle à l'intérieur et à l'extérieur, l'intérieur imitation bois, l'extérieur de couleur unie



NEW



84556

Schale „FRIDA“  
bowl  
cuenco  
bol



	☐ cm	↑ cm	GN	litr.		€
84555 8	17,6 x 10,8	5,5	1/9	0,5	○ ●	8,20
84556 5	17,6 x 10,8	5,5	1/9	0,5	● ●	8,20

Melamin  
melamine

NEW



84559

Schale „FRIDA“  
bowl  
cuenco  
bol



	☐ cm	↑ cm		litr.		€
84558 9	16,5 x 16,5	5,5		0,85	○ ●	7,60
84559 6	16,5 x 16,5	5,5		0,85	● ●	7,60
84561 9	25,0 x 25,0	7,5		2,65	○ ●	14,20
84562 6	25,0 x 25,0	7,5		2,65	● ●	14,20



84561

NEW



84564

Schale „FRIDA“  
bowl  
cuenco  
bol



	☐ cm	↑ cm	GN	litr.		€
84564 0	53,0 x 16,2	7,5	2/4	3,65	○ ●	24,00
84565 7	53,0 x 16,2	7,5	2/4	3,65	● ●	24,00



84565

**NEW**



**Schale „FRIDA STONE“  
bowl  
cuenco  
bol**



	cm	cm	GN	litr.		€
84557 2	17,6 x 10,8	5,5	1/9	0,5	●	8,20

**NEW**



**Schale „FRIDA STONE“  
bowl  
cuenco  
bol**



	cm	cm		litr.		€
84560 2	16,5 x 16,5	5,5		0,85	●	7,60
84563 3	25,0 x 25,0	7,5		2,65	●	14,20

**NEW**



**Schale „FRIDA STONE“  
bowl  
cuenco  
bol**



	cm	cm	GN	litr.		€
84566 4	53,0 x 16,2	7,5	2/4	3,65	●	24,00

**Einzelteile / spare parts / piezas sueltas / piècès détachées**



Deckel „PURE“, mit Löffelaussparung / cover, with notched for spoons  
tapa, con espacio para la cuchara / couvercle, avec encoche pour la louche

83601  
Deckel / cover

	cm	cm	passend für / suitable for	€
83601 3	25 x 25	1,5	84561, 84562, 84563	10,50



84562  
25,0 x 25,0 cm  
Schale / bowl

84561  
25,0 x 25,0 cm  
Schale / bowl



84562  
25,0 x 25,0 cm  
Schale / bowl

# FLOWER POT



designed by **CULTURE FORM**



84470  
Ø 6 cm  
Höhe 3,5 cm



84474  
Ø 9 cm  
Höhe 8,5 cm

84478  
Ø 12 cm  
Höhe 3,5 cm



84479  
Ø 13 cm  
Höhe 15 cm



84482  
Ø 20 cm  
Höhe 9 cm



15341  
Deckel / cover

## Schale „FLOWER POT“ bowl cuenco bol



	cm	↑ cm	ltr.		€
84470 4	Ø 6	3,5	0,04	○ white	1,20
84471 1	Ø 6	3,5	0,04	● terracotta	1,20
84472 8	Ø 6	3,5	0,04	● anthrazit	1,20
84473 5	Ø 9	8,5	0,30	○ white	4,00
84474 2	Ø 9	8,5	0,30	● terracotta	4,00
84475 9	Ø 9	8,5	0,30	● anthrazit	4,00
84476 6	Ø 12	3,5	0,20	○ white	3,20
84477 3	Ø 12	3,5	0,20	● terracotta	3,20
84478 0	Ø 12	3,5	0,20	● anthrazit	3,20
84479 7	Ø 13	15	1,00	○ white	12,00
84480 3	Ø 13	15	1,00	● terracotta	12,00
84481 0	Ø 13	15	1,00	● anthrazit	12,00
84482 7	Ø 20	9	1,80	○ white	14,00
84483 4	Ø 20	9	1,80	● terracotta	14,00
84484 1	Ø 20	9	1,80	● anthrazit	14,00

# TIMBER



Ø 35 cm  
Ø 44 cm



84268



84269



84256



**XXL**  
**70 x 26 cm**

**Tablett „TIMBER“  
tray  
bandeja  
plateau**



die Melaminplatten (Holzoptik Fichte) haben eine leichte Struktur und wirken optisch wie aus Holz gefertigt

superb spruce wood effect (timber), cutting edge gourmet presentation idea, never produce mould or sawdust, clean and hygienic, no more worries about crack

melamina imitación madera de picea, para recetas auténticas

mélamine imitation spruce, pour vos recettes authentiques

	cm	↑ cm	€
84266 3	Ø 35	3	25,00
84267 0	Ø 44	3	38,00
84268 7	44 x 25	1,5	20,00
84269 4	65 x 26	3	30,00
<b>NEW</b> 84256 4	70 x 26	3	59,00

# OAK



84177



84178



84179

**Tablett „OAK“  
tray  
bandeja  
plateau**



die Melaminplatten (Holzoptik Eiche) haben eine leichte Struktur und wirken optisch wie aus Holz gefertigt

superb oak wood effect, cutting edge gourmet presentation idea, never produce mould or sawdust, clean and hygienic, no more worries about crack

melamina imitación madera de roble, para recetas auténticas

mélamine imitation chêne, pour vos recettes authentiques

	cm	↑ cm	Grifflänge / handle cm	€
84177 2	Ø 30	1,5	12	21,00
84178 9	40 x 20	1,5	13	26,00
84179 6	48 x 20	1,5	13	32,00



# OAK LIGHT



Ø 35 cm  
Ø 44 cm



Tablett „OAK LIGHT“  
tray  
bandeja  
plateau



die Melaminplatten (Holzoptik Eiche) haben eine leichte Struktur und wirken optisch wie aus Holz gefertigt

superb oak wood effect, cutting edge gourmet presentation idea, never produce mould or sawdust, clean and hygienic, no more worries about crack

melamina imitación madera de roble, para recetas auténticas

mélamine imitation chêne, pour vos recettes authentiques



84264  
44 x 25 cm

	↓ cm	↑ cm	€
84262 5	Ø 35	3	25,00
84263 2	Ø 44	3	38,00



84255  
70 x 26 cm



84265  
65 x 26 cm

NEW

84264 9	44 x 25	1,5	20,00
84265 6	65 x 26	3	30,00
84255 7	70 x 26	3	59,00



**Tablett „OAK LIGHT“  
tray  
bandeja  
plateau**



	☐ cm	↑ cm	GN	€
84205 2	53,0 x 32,5	1,5	1/1	35,00
84206 9	32,5 x 26,5	1,5	1/2	18,40
84207 6	32,5 x 17,6	1,5	1/3	13,00
84208 3	26,5 x 16,2	1,5	1/4	10,50
84209 0	53,0 x 16,2	1,5	2/4	21,00



84206  
GN1/2



mit Antirutsch-Füßchen  
non-slip feet  
con pies antideslizantes  
avec pieds antidérapants



84208  
GN1/4

84208  
GN1/4

84209  
GN2/4

84206  
GN1/2



**Marmoroptik  
marble-look**

84362  
GN1/3

**Tablett „MARBLE“  
tray  
bandeja  
plateau**



Marmor-Look, glatte und hochglänzende Oberfläche  
marble-look, smooth and shiny surface  
look mármol, superficie lisa con acabado brillante  
look de marbre, surface lisse et finition brillante

	cm	↑ cm	GN		€
84360 8	53,0 x 32,5	1,5	1/1	○	36,00
84361 5	32,5 x 26,5	1,5	1/2	○	19,50
84362 2	32,5 x 17,6	1,5	1/3	○	14,00
84363 9	26,5 x 16,2	1,5	1/4	○	11,20
84364 6	53,0 x 16,2	1,5	2/4	○	22,00

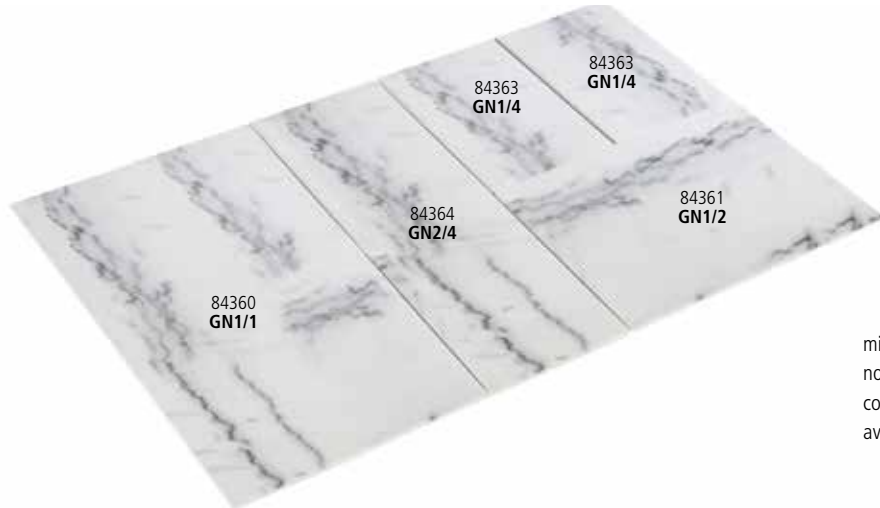

mit Antirutsch-Füßchen  
non-slip feet  
con pies antideslizantes  
avec pieds antidérapants



**glatte, hochglänzende Oberfläche  
smooth, shiny surface**

**Tablett „ZERO“  
tray  
bandeja  
plateau**



	cm	↑ cm	GN		€
84185 7	53,0 x 32,5	1,5	1/1	○	34,00
84186 4	32,5 x 26,5	1,5	1/2	○	18,20
84187 1	32,5 x 17,6	1,5	1/3	○	12,80
84188 8	26,5 x 16,2	1,5	1/4	○	10,40
84189 5	53,0 x 16,2	1,5	2/4	○	20,00
84195 6	53,0 x 32,5	1,5	1/1	●	34,00
84196 3	32,5 x 26,5	1,5	1/2	●	18,20
84197 0	32,5 x 17,6	1,5	1/3	●	12,80
84198 7	26,5 x 16,2	1,5	1/4	●	10,40
84199 4	53,0 x 16,2	1,5	2/4	●	19,00

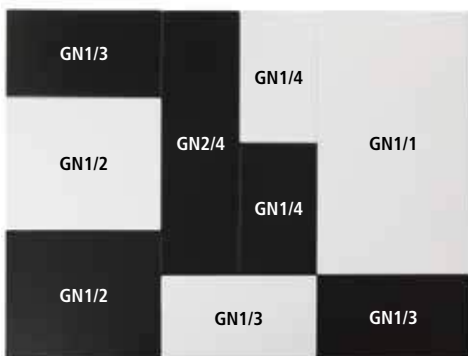

mit Antirutsch-Füßchen  
non-slip feet  
con pies antideslizantes  
avec pieds antidérapants





**Holzoptik  
wood-look**

**Tablett „DRIFTWOOD“  
tray  
bandeja  
plateau**



die Melaminplatten (Holzoptik) haben eine leicht wellige Oberfläche und wirken optisch wie aus Holz gefertigt

imagine the durability of melamine and the beauty of wood - fantastic imitation of wood

melamina imitación madera: madera con la durabilidad de la melamina gracias a la superficie ligeramente irregular de la melamina.

mélamine imitation bois: toute bois mais avec la durabilité de la mélamine, la surface irrégulière renforce l'aspect naturel

	□ cm	↑ cm	GN	€
84180 2	53,0 x 32,5	1,5	1/1	35,00
84181 9	32,5 x 26,5	1,5	1/2	18,40
84182 6	32,5 x 17,6	1,5	1/3	13,00
84183 3	26,5 x 16,2	1,5	1/4	10,50
84184 0	53,0 x 16,2	1,5	2/4	21,00



84182  
GN1/3

mit Antirutsch-Füßchen  
non-slip feet  
con pies antideslizantes  
avec pieds antidérapants



**Granitoptik  
granit-look**

**Tablett „GRANIT“  
tray  
bandeja  
plateau**



die Melaminplatten (Granitoptik) haben eine leicht wellige Oberfläche und wirken optisch wie der Naturstein Granit

fantastic imitation of granit stone

Melamina: excelente imitación del granito natural con el acabado irregular de la superficie de la melamina.

Mélamine imitation granit naturel. La surface irrégulière renforce l'aspect de la pierre naturelle.

	□ cm	↑ cm	GN	€
84190 1	53,0 x 32,5	1,5	1/1	34,80
84191 8	32,5 x 26,5	1,5	1/2	18,40
84192 5	32,5 x 17,6	1,5	1/3	13,00
84193 2	26,5 x 16,2	1,5	1/4	10,50
84194 9	53,0 x 16,2	1,5	2/4	21,00



84183  
GN1/4

mit Antirutsch-Füßchen  
non-slip feet  
con pies antideslizantes  
avec pieds antidérapants



# SLATE



Die schwarzen Melaminplatten überzeugen mit ihrem edlen und schlichten Schieferlook und einer rauhen Oberfläche.

Fantastic imitation of slate. This plates add a rustic feel to your display. Perfect presentation for cheese, chocolates, pastry and meat.

Las bandejas de melamina negra ofrecen un aspecto de pizarra elegante y discreto.

Les plats en mélamine noire offrent l'aspect de l'ardoise, élégants et discrets.

## Tablett „SLATE“ tray bandeja plateau



	cm	cm	€
83992 2	Ø 30	1	18,90
83994 6	Ø 40	1	30,00



Ø 30 cm



Ø 40 cm

mit Antirutsch-Füßchen  
non-slip feet  
con pies antideslizantes  
avec pieds antidérapants





GN1/1

**GN-Tablett „SLATE“**  
tray  
bandeja  
plateau



	cm	↑ cm	GN	€
83981 6	53,0 x 32,5	1,5	1/1	40,00

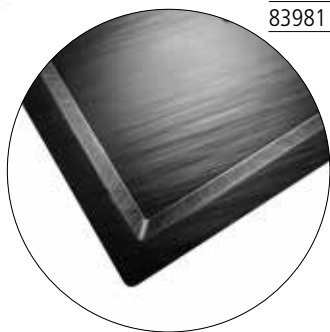

**Schieferoptik**  
slate look



**Gastronorm-Maße**  
gastronorm-sizes

**Tablett „SLATE“**  
tray  
bandeja  
plateau



	cm	↑ cm	GN	€
83955 7	53,0 x 32,5	1	1/1	38,00
83956 4	32,5 x 26,5	1	1/2	20,00
83957 1	32,5 x 17,5	1	1/3	13,80
83958 8	26,5 x 16,2	1	1/4	11,00
83971 7	53,0 x 16,2	1	2/4	22,00



4 cm

**Tablett „SLATE“**  
tray  
bandeja  
plateau empilable système catering



massive Metallgriffe verchromt inkl. fest verschraubten 4 cm Distanzstücken  
chrome plated handles, incl. mounted 4 cm distance pillars  
asas cromadas, incluye distanciadores a 4 cm  
poignées chromées, distance approx. 4 cm



GN1/1

	cm	↑ cm	GN	€
83980 9	53,0 x 32,5	6	1/1	47,00



**2 Größen**  
2 sizes

**Schale „SLATE“**  
bowl  
cuenco  
bol



	cm	↑ cm	ltr.	€
<b>NEW</b> 84244 1	19,0 x 19,0	9	1,5	20,00
84245 8	25,0 x 25,0	12	3,8	34,00

**Einzelteile / spare parts / piezas sueltas / pièces détachées**

Deckel „PURE“, mit Löffelaussparung / cover, with notched for spoons / tapa, con espacio para la cuchara / couvercle, avec encoche pour la louche

	cm	↑ cm	passend für / suitable for	€
83600 6	19 x 19	1,5	84244	8,00
83601 3	25 x 25	1,5	84245	10,50

# SLATE designed by EsserDesign



**Tablett „SLATE“**  
tray  
bandeja  
plateau



	□ cm	↑ cm	Grifflänge (cm)	Loch (cm)	€
84240 3	Ø 18,5	1,5	8,5	1,5	8,40
84241 0	Ø 23,0	1,5	10	2	12,80
84242 7	Ø 33,5	1,5	14	2,5	25,00
84243 4	Ø 37,0	1,5	15,5	3	30,00

**Zubehör / spare parts / recambios / pièces de rechange**



Frischhalte-Haube / cover / campana / cloche

	□ cm	↑ cm	matches	€
15350 9	Ø 16,5	10	84240	10,00
15351 6	Ø 20,5	10	84241	12,00
06512 3	Ø 30	11,5	84242	5,90
06517 8	Ø 33	12,5	84243	6,90

**passende Hauben / covers**  
15350, 15351



**feine Schiefer-Optik**  
fine slate optic



**passende Tablett / trays**  
84240, 84241

**passende Hauben / covers**  
06512, 80657



**passende Tablett / trays**  
84242, 84243

# SLATE-ROCK



**NEW**

## Tablett „SLATE-ROCK“ tray bandeja plat



Die schwarzen Melaminplatten überzeugen mit ihrem edlen Schieferlook.

Fantastic imitation of slate. This plates add a rustic feel to your display. Perfect presentation for cheese, chocolates, pastry and meat.

Las bandejas de melamina negras ofrecen un aspecto de pizarra elegante y discreto.

Les plats en mélamine noire offrent l'aspect de l'ardoise, élégants et discrets.



84257  
Ø 30 cm



84258  
40 x 20 cm



84259  
48 x 20 cm



84246  
20 x 10 cm

84246  
20 x 10 cm

84246  
20 x 10 cm

84246  
20 x 10 cm



84248  
30 x 15 cm

84247  
30 x 10 cm

84247  
30 x 10 cm

	cm	↑ cm	Grifflänge / handle cm	€
84257 1	Ø 30	1,5	12	20,00
84258 8	40 x 20	1,5	13	25,00
84259 5	48 x 20	1,5	13	30,00
84246 5	20 x 10	2		6,20
84247 2	30 x 10	2		8,40
84248 9	30 x 15	2		10,60

# TIERRA designed by CULTURE FORM



84293  
17,0 x 8,5 cm

84290  
Ø 10,0 cm

84292  
21,5 x 10,5 cm

84291  
Ø 13,5 cm



## Schale „TIERRA“ bowl cuenco bol



	▣ cm	↑ cm	litr.		€
84290 8	Ø 10	7	0,13	●	3,00
84295 3	Ø 10	7	0,13	○	3,00



## Teller „TIERRA“ tray bandeja plateau



	▣ cm	↑ cm	litr.		€
84291 5	Ø 13,5	3	0,13	●	3,40
84296 0	Ø 13,5	3	0,13	○	3,40



## Tablett „TIERRA“ tray bandeja plateau



	▣ cm	↑ cm	litr.		€
84292 2	21,5 x 10,5	1,5		●	4,00
84297 7	21,5 x 10,5	1,5		○	4,00

oval flach



## Schale „TIERRA“ bowl cuenco bol



	▣ cm	↑ cm	litr.		€
84293 9	17,0 x 8,5	4	0,2	●	4,00
84298 4	17,0 x 8,5	4	0,2	○	4,00

oval hoch



GN1/1  
GN1/2

**Tablett „TIERRA“**  
tray  
bandeja  
plateau



	□ cm	↑ cm	GN		€
84270 0	53,0 x 32,5	2,5	1/1	●	36,00
84271 7	32,5 x 26,5	2,5	1/2	●	18,00
84280 9	53,0 x 32,5	2,5	1/1	○	36,00
84281 6	32,5 x 26,5	2,5	1/2	○	18,00



GN2/4

**Tablett „TIERRA“**  
tray  
bandeja  
plateau



	□ cm	↑ cm	GN		€
84272 4	53,0 x 16,2	2,5	2/4	●	19,00
84282 3	53,0 x 16,2	2,5	2/4	○	19,00



oval

**Schale, oval „TIERRA“**  
bowl, oval  
cuenco, ovalado  
bol, ovale



	□ cm	↑ cm		€
84275 5	40 x 20	2,5	●	16,00
84285 4	40 x 20	2,5	○	16,00



1 Liter und  
2,5 Liter

**Schale „TIERRA“**  
bowl  
cuenco  
bol



	□ cm	↑ cm	ltr.		€
84273 1	19 x 19	8	1	●	14,50
84274 8	25 x 25	10	2,5	●	27,00
84283 0	19 x 19	8	1	○	14,50
84284 7	25 x 25	10	2,5	○	27,00



Ø 32 cm und  
Ø 40,5 cm

**Teller „TIERRA“**  
plate  
plato  
assiette



	□ cm	↑ cm		€
84276 2	Ø 32,0	3,5	●	22,00
84277 9	Ø 40,5	5,5	●	32,00
84286 1	Ø 32,0	3,5	○	22,00
84287 8	Ø 40,5	5,5	○	32,00

# AIKO



84320  
rund / round

**Tablett / Teller „AIKO“  
plate / tray  
plato / bandeja  
assiette / plateau**



Steinoptik  
appearance stoneware  
su aspecto recuerda al gres  
l'aspect de la mélamine rapelle le grès

	□ cm	↑ cm		€
84320 2	Ø 16	2	○	4,60
84321 9	Ø 16	2	●	4,60
84322 6	Ø 26,5	2,5	○	9,90
84323 3	Ø 26,5	2,5	●	9,90



84322



**Tablett / Teller „AIKO“**  
**plate / tray**  
**plato / bandeja**  
**assiette / plateau**



oval

Steinoptik  
appearance stoneware  
su aspecto recuerda al gres  
l'aspect de la mélamine rapelle le grès

	cm	cm		€
84324 0	33 x 25	2,5	○	12,90
84325 7	33 x 25	2,5	●	12,90

**Schale „AIKO“**  
**bowl**  
**cuenco**  
**bol**



oval

Steinoptik  
appearance stoneware  
su aspecto recuerda al gres  
l'aspect de la mélamine rapelle le grès

	cm	cm	ltr.	€
84326 4	26,5 x 19,5	6	0,9	9,90
84327 1	26,5 x 19,5	6	0,9	9,90

**Schale „AIKO“**  
**bowl**  
**cuenco**  
**bol**



Steinoptik  
appearance stoneware  
su aspecto recuerda al gres  
l'aspect de la mélamine rapelle le grès

	cm	cm	ltr.	€
84328 8	Ø 8	4	0,07	3,20
84329 5	Ø 8	4	0,07	3,20
84330 1	Ø 11,5	6	0,2	4,20
84331 8	Ø 11,5	6	0,2	4,20

**Schale „AIKO“**  
**bowl**  
**cuenco**  
**bol**



3 Größen / 3 sizes  
0,3 - 1,2 ltr.

Steinoptik  
appearance stoneware  
su aspecto recuerda al gres  
l'aspect de la mélamine rapelle le grès

	cm	cm	ltr.	€
84332 5	Ø 12,5	6	0,3	5,40
84333 2	Ø 12,5	6	0,3	5,40
84334 9	Ø 16	7	0,6	6,80
84335 6	Ø 16	7	0,6	6,80
84336 3	Ø 20,5	8	1,2	10,50
84337 0	Ø 20,5	8	1,2	10,50

# LA VIDA designed by CULTURE FORM



84148  
Ø 32,5 x 26,5 cm

84161  
Ø 32,0 cm

84144  
53,0 x 32,5 cm



Ø 32cm  
Ø 40,5 cm



84149  
GN2/4



84144  
GN1/1



84148  
GN1/2

**Teller / Tablett „LA VIDA“**  
plate / tray  
plato / bandeja  
assiette / plateau



	□ cm	↑ cm		GN	€
84161 1	Ø 32,0	3,5	●		28,00
84170 3	Ø 40,5	5,5	●		40,00
84165 9	Ø 32,0	3,5	●		28,00
84168 0	Ø 40,5	5,5	●		40,00
84171 0	Ø 32,0	3,5	●		28,00
84172 7	Ø 40,5	5,5	●		40,00
84144 4	53,0 x 32,5	2,5	●	1/1	39,00
84145 1	32,5 x 26,5	2,5	●	1/2	21,00
84146 8	53,0 x 16,2	2,5	●	2/4	22,00
84147 5	53,0 x 32,5	2,5	●	1/1	39,00
84148 2	32,5 x 26,5	2,5	●	1/2	21,00
84149 9	53,0 x 16,2	2,5	●	2/4	22,00

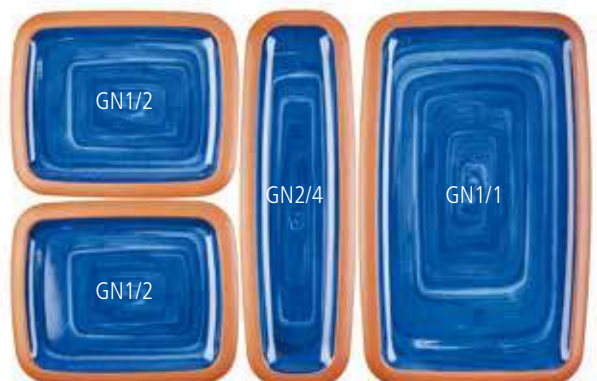

# MARONE



Schwarze Serie in Naturoptik mit braunem Rand

Body in black with brown edge

Formas orgánicas con aspecto parecido a materiales naturales, con color negro con borde marrón

Formes organiques à l'apparence proche du naturel, couleur noire avec rebords marron



84100

Blattschale „MARONE“  
leaf  
fuente en forma de hoja  
plat feuille



	cm	↑ cm	ltr.	€
84100 0	25,5 x 14	5,5	0,4	7,80
84101 7	36 x 19	8	0,9	12,00



84101

Tablett „MARONE“  
tray  
bandeja  
plateau



	cm	↑ cm	€
84103 1	14,5 x 14,5	2	5,20



Tablett „MARONE“  
tray  
bandeja  
plateau



	cm	↑ cm	€
84104 8	22,5 x 15	3	9,60
84105 5	27,5 x 11	2	9,60



Tablett „MARONE“  
tray  
bandeja  
plateau



	cm	↑ cm	€
84106 2	26,5 x 16,5	4	11,00

NEW

Tablett "MARONE"  
tray  
bandeja  
plateau



84117  
19,5 x 9,5 cm



84118  
39,0 x 16,0 cm

	□ cm	↑ cm	€
84117 8	19,5 x 9,5	2,0	8,00
84118 5	39,0 x 16,0	3,0	16,00

NEW

Tablett "MARONE"  
tray  
bandeja  
plateau



	□ cm	↑ cm	€
84119 2	32,5 x 23,5	4,5	16,00

NEW

Schale "MARONE"  
bowl  
cuenco  
bol



	□ cm	↑ cm	ltr.	€
84174 1	Ø 30,5	8,5	2,0	19,00



84113

Schale „MARONE“  
bowl  
cuenco  
bol



	□ cm	↑ cm	ltr.	€
84110 9	Ø 14	6	0,30	6,20
84111 6	Ø 19	8	0,80	11,00
84112 3	Ø 21	8,5	1,00	11,40
84113 0	Ø 24	9,5	1,40	13,40



Schale „MARONE“  
bowl  
cuenco  
bol



	cm	cm	ltr.	€
84114 7	23,5 x 23,5	6,5	0,70	12,00



84116

Schale „MARONE“  
bowl  
cuenco  
bol



	cm	cm	ltr.	€
84115 4	Ø 11	3,5	0,13	5,20
84116 1	Ø 14	4	0,20	5,60



Schale „MARONE“  
bowl  
cuenco  
bol



	cm	cm	ltr.	€
84109 3	Ø 11	5,5	0,2	5,00



Schale „MARONE“  
bowl  
cuenco  
bol



	cm	cm	ltr.	€
84107 9	Ø 8,5	2,5	0,05	4,80



Schale „MARONE“  
bowl  
cuenco  
bol



	cm	cm	ltr.	€
84108 6	Ø 11,5	3	0,04	5,20

# ZEN



Fernöstliche Tisch- und Buffetartikel präsentiert die Serie **ZEN**.  
Japanische und chinesische Köstlichkeiten können traditionell in Szene gesetzt werden.  
Die Optik entspricht dem japanischen Steingut.

The **ZEN** series presents Far Eastern table and buffet articles.  
Japanese and Chinese specialities can be served in a traditional setting.  
The appearance is that of Japanese stoneware.

La colección **ZEN** presenta artículos de bufé y mesa para cocina oriental. Las delicias japonesas y chinas se pueden poner en escena siguiendo la tradición. Su aspecto recuerda al gres japonés.

La collection **ZEN** présente des articles de buffet et de table pour la cuisine orientale. Les délices japonaises et chinoises entrent en scène selon la plus pure tradition. L'aspect de la mélamine rappelle le grès japonais.



**Schale „ZEN“**  
bowl  
cuenco  
bol



	□ cm	↑ cm		€
83928 1	Ø 31	8,5	○	22,00
83929 8	Ø 31	8,5	●	22,00



**Schale „ZEN“**  
bowl  
cuenco  
bol



	□ cm	↑ cm	ltr.		€
83710 2	21 x 21	11	1,4	○	11,00
83712 6	21 x 21	11	1,4	●	11,00



**Schale „ZEN“  
bowl  
cuenco  
bol**



	cm	↑ cm	litr.		€
84354 7	Ø 22,5	12,5	0,80	○	10,20
84355 4	Ø 22,5	12,5	0,80	●	10,20



84351

**Schale „ZEN“  
bowl  
cuenco  
bol**



	cm	↑ cm	litr.		€
84348 6	Ø 10	7	0,08	○	2,80
84350 9	Ø 12,5	8,5	0,15	○	4,20
84352 3	Ø 16	10	0,30	○	6,80
84349 3	Ø 10	7	0,08	●	2,80
84351 6	Ø 12,5	8,5	0,15	●	4,20
84353 0	Ø 16	10	0,30	●	6,80



84341

**Schale „ZEN“  
bowl  
cuenco  
bol**



	cm	↑ cm	litr.		€
84340 0	7 x 7	2	0,03	○	1,80
84342 4	9 x 9	2,5	0,06	○	2,10
84344 8	13,5 x 13	4	0,20	○	4,00
84346 2	16 x 15,5	4,5	0,30	○	5,00
84341 7	7 x 7	2	0,03	●	1,80
84343 1	9 x 9	2,5	0,06	●	2,10
84345 5	13,5 x 13	4	0,20	●	4,00
84347 9	16 x 15,5	4,5	0,30	●	5,00



**Schale „ZEN“  
bowl  
cuenco  
bol**



	cm	↑ cm	litr.		€
83729 4	18 x 10	3,5	0,10	○	3,20
83733 1	25 x 13,5	4	0,25	○	4,20
83737 9	30,5 x 17,5	5	0,60	○	8,40
83731 7	18 x 10	3,5	0,10	●	3,20
83735 5	25 x 13,5	4	0,25	●	4,20
83739 3	30,5 x 17,5	5	0,60	●	8,40



**Schale „ZEN“  
bowl  
cuenco  
bol**



	cm	↑ cm	litr.		€
83714 0	17,5 x 17,5	7	0,5	○	6,60
83716 4	17,5 x 17,5	7	0,5	●	6,60



**Dipschälchen „ZEN“  
bowl  
cuencos para salsas  
ramequin**



	cm	cm	litr.		€
83721 8	Ø 8	1,5	0,03	○	1,00
83723 2	Ø 8	1,5	0,03	●	1,00



**Schale „ZEN“  
bowl  
cuenco  
bol**



	cm	cm	litr.		€
83725 6	10,5 x 10,5	3	0,06	○	2,50
83727 0	10,5 x 10,5	3	0,06	●	2,50



**Schale „ZEN“  
bowl  
cuenco  
bol**



	cm	cm	litr.		€
83726 3	13 x 11	3,5	0,1	○	2,50
83728 7	13 x 11	3,5	0,1	●	2,50



**Schale „ZEN“  
bowl  
cuenco  
bol**



	cm	cm	litr.		€
83718 8	12 x 12	4	0,2	○	4,20
83720 1	12 x 12	4	0,2	●	4,20



**Schale „ZEN“  
bowl  
fuente alargada  
plat long**



	cm	cm			€
83938 0	32,5 x 14	4		○	11,00
83939 7	32,5 x 14	4		●	11,00



**Schale „ZEN“  
bowl  
cuenco  
bol**



	cm	cm	litr.		€
83730 0	11 x 10	3	0,04	○	2,30
83732 4	11 x 10	3	0,04	●	2,30





Schale „ZEN“  
bowl  
cuenco  
bol



	☐ cm	↑ cm	ltr.		€
83722 5	17,5 x 15,5	5,5	0,2	○	6,00
83724 9	17,5 x 15,5	5,5	0,2	●	6,00



Schale „ZEN“  
bowl  
cuenco  
bol



	☐ cm	↑ cm	ltr.		€
83934 2	14,5 x 12,5	5	0,2	○	4,60
83935 9	14,5 x 12,5	5	0,2	●	4,60



Schale „ZEN“  
bowl  
cuenco  
bol



	☐ cm	↑ cm	ltr.		€
83932 8	Ø 11,5	4	0,15	○	4,40
83933 5	Ø 11,5	4	0,15	●	4,40



Schale „ZEN“  
bowl  
cuenco  
bol



	☐ cm	↑ cm	ltr.		€
83946 5	9 x 7	2,5	0,05	○	3,20
83947 2	9 x 7	2,5	0,05	●	3,20



Tablett / Teller „ZEN“  
tray / plate  
bandeja / plato  
plateau / assiette



	☐ cm	↑ cm		€
83940 3	Ø 28	3	○	9,50
83941 0	Ø 28	3	●	9,50





**Tablett „ZEN“**  
tray  
bandeja  
plateau



	cm	cm		€
83734 8	23,5 x 23	5,5	○	8,40
83736 2	23,5 x 23	5,5	●	8,40



**Tablett, Sushiboard „ZEN“**  
tray, sushiboard  
bandeja para sushi  
plateau sushi



	cm	cm		€
83742 3	22,5 x 9,5	3	○	4,20
83744 7	22,5 x 9,5	3	●	4,20



**Tablett, Sushiboard „ZEN“**  
tray, sushiboard  
bandeja para sushi  
plateau sushi



	cm	cm		€
83738 6	22 x 12	3	○	5,60
83740 9	22 x 12	3	●	5,60



83942



83943

**Tablett, quadratisch „ZEN“**  
tray, square  
bandeja cuadrada  
plateau carré



	cm	cm		€
83942 7	20 x 20	4,5	○	9,80
83944 1	25 x 25	5,5	○	11,90
83943 4	20 x 20	4,5	●	9,80
83945 8	25 x 25	5,5	●	11,90



**Schale „ZEN“**  
bowl  
cuenco  
bol



	cm	cm		€
83948 9	14 x 9	2,5	○	3,70
83949 6	14 x 9	2,5	●	3,70

# FUSION



Tisch- und Buffetservierartikel präsentiert die Serie FUSION. Die Oberflächen der Artikel sind innen hoch glänzend und außen mattiert. Das besondere Design beansprucht höchste Aufmerksamkeit und bringt Speisen optimal zur Geltung. Somit werden die Speisen noch mehr in den Blickpunkt gerückt.

The FUSION presents table and buffet articles. The design and surface is unique. Mirror shiny inside, outside matt.

La línea FUSION presenta artículos para la mesa y el bufé. El diseño y el acabado son únicos, interior pulido brillante y exterior acabado en mate.

La ligne FUSION présente des articles pour la table et le buffet. Le design et la finition sont tout à fait uniques. Intérieur poli brillant et extérieur mat.



84022  
Ø 11 cm

## Schale „FUSION“ bowl cuenco bol



	☐ cm	↑ cm	ltr.	€
84022 5	Ø 11	7,0	0,3	5,60
84023 2	Ø 17	8,5	1,0	10,20
84024 9	Ø 20	8,0	1,2	14,40



84023

Ø 17 cm



84023



84024

Ø 20 cm



84024



84025

## Tablett „FUSION“ tray bandeja plateau



	☐ cm	↑ cm	€
84025 6	23,5 x 7,5	2,0	5,60
84026 3	24,5 x 6,5	1,5	4,70



84025



84026



84026

# HALFTONE



Löffel „HALFTONE“  
spoon  
cuchara  
cuillère



	□ cm	↑ cm	€
84158 1	Ø 5,5	7,0	3,00

Teller „HALFTONE“  
plate  
plato  
assiette



84227

	□ cm	↑ cm	litr.	€
84226 7	Ø 13,5	2,5	0,1	4,40
84227 4	Ø 16,0	3,0	0,2	5,20



84217

Schale „HALFTONE“  
bowl  
cuenco  
bol



	□ cm	↑ cm	litr.	€
84217 5	Ø 8,0	4,0	0,1	3,20
84218 2	Ø 8,5	3,5	0,05	3,20

84218





**Fingerfood Löffel „HALFTONE“**  
party spoon  
cuchara party  
cuillère party



	cm	cm	cm	€
84128 4	14,5 x 4,5	4,5		3,00



**Schale „HALFTONE“**  
bowl  
cuenco  
bol



	cm	cm	litr.	€
84129 1	7,5 x 7,5	3,5	0,05	2,70



**Schale „HALFTONE“**  
bowl  
cuenco  
bol



	cm	cm	litr.	€
84130 7	11,5 x 7	4	0,05	3,00
84131 4	14 x 8	4,5	0,10	3,70
84132 1	15 x 9,5	5	0,15	4,20



**Schale „HALFTONE“**  
bowl  
cuenco  
bol



	cm	cm	litr.	€
84133 8	17,5 x 13,5	6,5	0,35	6,20
84134 5	24 x 17,5	7,5	0,8	11,00



**Schale „HALFTONE“**  
bowl  
cuenco  
bol



	cm	cm	litr.	€
84135 2	Ø 16,5	7,5	0,65	9,00
84136 9	Ø 19	8,5	1	11,00



**Blattschale „HALFTONE“**  
leaf  
fuente en forma de hoja  
plateau feuille



	▣ cm	↑ cm	€
84120 8	37,5 x 15,5	4,5	11,00
84121 5	46,5 x 21	6,5	17,00



**Blattschale „HALFTONE“**  
leaf  
fuente en forma de hoja  
plateau feuille



	▣ cm	↑ cm	€
84122 2	34 x 13	3	9,50



**Teller „HALFTONE“**  
plate  
plato  
assiette



	▣ cm	↑ cm	€
84123 9	Ø 16	2,5	4,20



**Tablett „HALFTONE“**  
tray  
bandeja  
plateau



	▣ cm	↑ cm	€
84124 6	20,5 x 12,5	3	6,20
84125 3	24,5 x 15	3	7,80
84127 7	34,5 x 21,5	3	16,00
84126 0	29 x 18	4	9,80



**Schale „HALFTONE“**  
bowl  
cuenco  
bol



	▣ cm	↑ cm	ltr.	€
84137 6	Ø 26	9	1,5	18,00

# SINUS designed by CULTURE FORM

Charakterstark und mit dem hohen Anspruch an Funktionalität und Design präsentiert sich die Buffetserie SINUS. Die großzügigen Flächen für die Speisenpräsentation sind ausdrucksstark eingefasst und gewährleisten ein optimales Handling im Gastronomiealltag.

Buffetrange SINUS presents a modern look and feel of this endearing Gastro Norm series disguises the functional and versatile features.

SINUS: carácter, funcionalidad y diseño para el bufé. Las generosas dimensiones de las piezas SINUS se combinan para crear un montaje de buffet práctico y con personalidad apto al uso profesional a diario.

SINUS: Caractère, fonctionnalité et design. Les généreuses dimensions des pièces de la collection et leur combinaison permettent le montage d'un buffet à la fois pratique et de caractère, apte à un intensif usage quotidien.



84261  
GN2/4



84230  
GN1/1

84231



84261

## GN Tablett „SINUS“ tray bandeja plat



	□ cm	GN	↑ cm		€
84230 4	53 x 32,5	1/1	2	○	28,40
84231 1	53 x 16,2	2/4	2	○	17,00
84260 1	53 x 32,5	1/1	2	●	28,40
84261 8	53 x 16,2	2/4	2	●	17,00



## 4 Größen / 4 sizes



0,1 ltr. bis 3,5 ltr.

## Schale „SINUS“ bowl cuenco bol



	□ cm	↑ cm	ltr.	€
84229 8	10,5 x 10,5	4,0	0,1	3,80
84232 8	21,0 x 21,0	9,0	1,5	17,40
84233 5	25,0 x 25,0	11,0	2,4	22,40
84234 2	28,5 x 28,5	12,5	3,5	26,40

# TAO

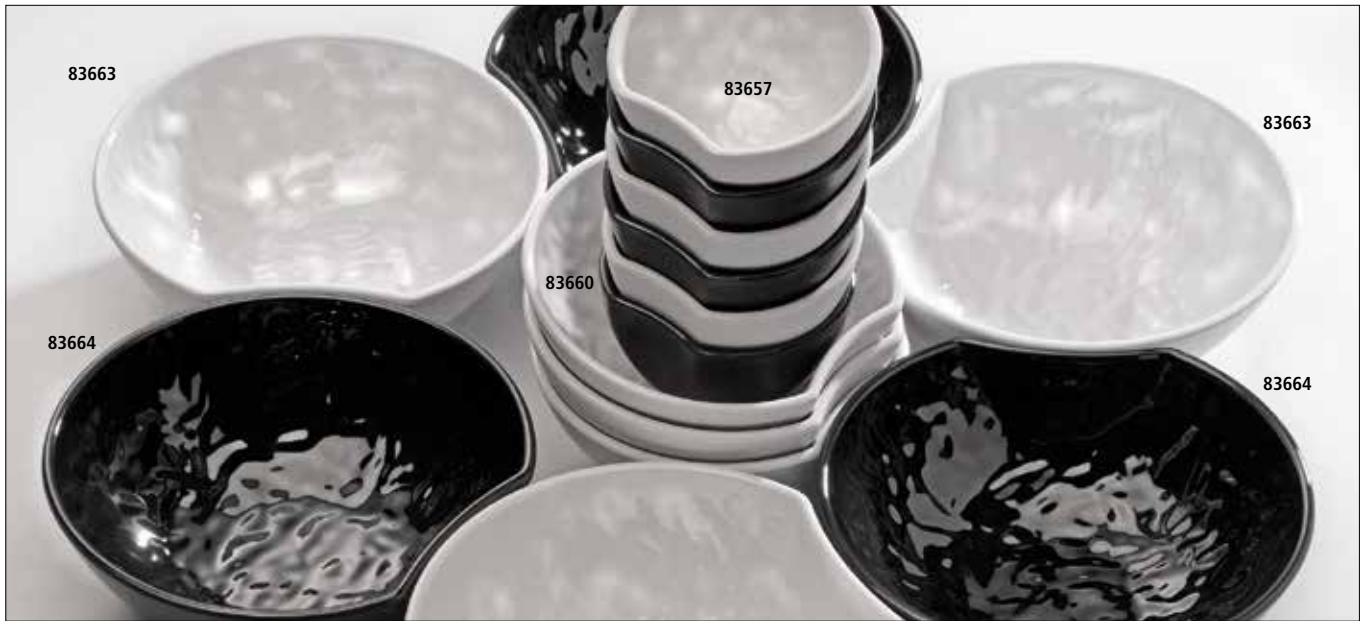

**Schale, rund „TAO“  
bowl, round  
bol redondo  
bol rond avec encoche**



	□ cm	↑ cm	litr.		€
83657 0	9,5 x 9,0	6,0	0,15	○	3,40
83660 0	14,5 x 13,5	6,0	0,4	○	5,00
83663 1	18,0 x 16,5	6,5	0,7	○	7,60
83658 7	9,5 x 9,0	6,0	0,15	●	3,40
83661 7	14,5 x 13,5	6,0	0,4	●	5,00
83664 8	18,0 x 16,5	6,5	0,7	●	7,60

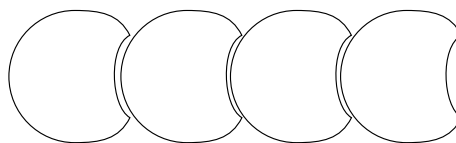

**Schale, rund „TAO“  
bowl, round  
bol redondo  
bol rond coupe optique**



	□ cm	↑ cm	litr.		€
83648 8	10,5 x 10,0	6,5 / 3,0	0,07	○	3,40
83651 8	13,5 x 12,5	8,5 / 4,0	0,15	○	5,00
83654 9	17,0 x 16,0	10,5 / 4,5	0,3	○	7,40
83649 5	10,5 x 10,0	6,5 / 3,0	0,07	●	3,40
83652 5	13,5 x 12,5	8,5 / 4,0	0,15	●	5,00
83655 6	17,0 x 16,0	10,5 / 4,5	0,3	●	7,40





mit Antirutsch-Füßchen  
non-slip feet  
con pies antideslizantes  
avec pieds antidérapants



83640

**Schale, rechteckig „TAO“**  
**bowl, rectangular**  
**cuenco, rectangular**  
**plat creux rectangulaire**



	cm	↑ cm	ltr.		€
83639 6	32,5 x 17,5	10	1,8	○	14,50
83640 2	32,5 x 17,5	10	1,8	●	14,50



83642

**Schale, quadratisch „TAO“**  
**bowl, square**  
**bol cuadrado**  
**plat creux carré**



	cm	↑ cm	ltr.		€
83642 6	30,5 x 30,5	10	3,3	○	18,50
83643 3	30,5 x 30,5	10	3,3	●	18,50



83643

**Schale, quadratisch „TAO“**  
**bowl, square**  
**bol cuadrado**  
**plat creux carré irrégulier**



	cm	↑ cm	ltr.		€
83645 7	33,5 x 33,5	13,5	3,8	○	22,00
83646 4	33,5 x 33,5	13,5	3,8	●	22,00



83646

**Schale „TAO“**  
**bowl**  
**cuenco**  
**plat ovale creux**



	cm	↑ cm		€
83630 3	18,0 x 10,0	3,5	○	4,00
83633 4	25,0 x 13,5	4,5	○	5,80
83636 5	30,5 x 17,5	5,0	○	9,00
83631 0	18,0 x 10,0	3,5	●	4,00
83634 1	25,0 x 13,5	4,5	●	5,80
83637 2	30,5 x 17,5	5,0	●	9,00



# GLOBAL BUFFET



Schale „GLOBAL BUFFET“  
bowl  
cuenco  
bol

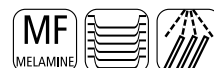

	□ cm	↑ cm	litr.		€
83785 0	32,5 x 32,5	12,0	3,0	○	21,00
83786 7	35,0 x 35,0	12,5	3,5	○	26,40
83787 4	40,0 x 40,0	13,5	5,0	○	33,90
84785 9	32,5 x 32,5	12,0	3,0	●	21,00
84786 6	35,0 x 35,0	12,5	3,5	●	26,40
84787 3	40,0 x 40,0	13,5	5,0	●	34,00



Schale „GLOBAL BUFFET“  
bowl  
cuenco  
bol



	□ cm	↑ cm	litr.		€
83799 7	Ø 25,5	13,0	3,0	○	17,00
83788 1	Ø 32,0	16,5	4,5	○	21,40
83789 8	Ø 35,0	17,0	6,0	○	26,40
83790 4	Ø 40,0	17,5	8,0	○	34,00
83779 9	Ø 25,5	13,0	3,0	●	17,00
84788 0	Ø 32,0	16,5	4,5	●	21,40
84789 7	Ø 35,0	17,0	6,0	●	26,40
84790 3	Ø 40,0	17,5	8,0	●	34,00



Schale „GLOBAL BUFFET“  
bowl  
cuenco  
bol



	□ cm	↑ cm	litr.		€
83791 1	32 x 32	12,0	2,5	○	22,00
83792 8	36 x 36	12,5	4,0	○	26,40
83793 5	40 x 40	14,0	5,5	○	34,40



Tablett „GLOBAL BUFFET“  
tray  
bandeja  
plateau



	□ cm	↑ cm			€
83794 2	30,5 x 30,5	4	quadratisch/square	○	20,00
83795 9	36,0 x 36,0	5	quadratisch/square	○	26,40
83796 6	38,5 x 29,5	5	rechteckig/rectangular	○	26,40
83797 3	44,0 x 34,5	5	rechteckig/rectangular	○	33,00

83796, 83797

**NEW**



84383  
30,5 x 30,5 cm



84385  
40,0 x 40,0 cm

**Tablett „GLOBAL BUFFET“  
tray  
bandeja  
plat**



die Melaminplatten (Steinoptik) haben eine leicht wellige Oberfläche und wirken optisch wie der Naturstein Granit

fantastic imitation of granit stone

melamina: excelente imitación del granito natural con el acabado irregular de la superficie de la melamina

mélamine imitation granit naturel. La surface irrégulière renforce l'aspect de la pierre naturelle

	cm	cm	cm	€
84383 7	30,5 x 30,5	4	●	12,00
84385 1	40 x 40	4	●	19,00

**NEW**



**Schale „GLOBAL BUFFET“  
bowl  
cuenco  
bol**



die Melaminschale (Steinoptik) hat eine leicht wellige Oberfläche und wirkt optisch wie der Naturstein Granit

fantastic imitation of granit stone

melamina: excelente imitación del granito natural con el acabado irregular de la superficie de la melamina

mélamine imitation granit naturel. La surface irrégulière renforce l'aspect de la pierre naturelle

	cm	cm	litr.	€	
84387 5	36 x 36	11	3,5	●	24,00

**NEW**



**Schale „GLOBAL BUFFET“  
bowl  
cuenco  
bol**



	cm	cm	litr.	€	
84462 9	44 x 25	20	3,3	○	19,00

**NEW**



**Schale „GLOBAL BUFFET“  
bowl  
cuenco  
bol**



	cm	cm	litr.	€	
84464 3	35,5 x 31,5	14	2,5	○	16,00
84466 7	46 x 40	18,5	5,5	○	29,00

# BALANCE designed by CULTURE FORM



stapelbar  
stackable  
apilables  
empilable

+



0,4 - 5,0 ltr.



Schale „BALANCE“  
bowl  
cuenco  
saladier



	□ cm	↑ cm	ltr.		€
84040 9	Ø 14,5	9,0	0,4	○	5,20
84041 6	Ø 21,0	13,0	1,5	○	11,50
84042 3	Ø 24,5	15,0	2,5	○	15,00
84043 0	Ø 30,0	19,5	5,0	○	25,00
85040 8	Ø 14,5	9,0	0,4	●	5,20
85041 5	Ø 21,0	13,0	1,5	●	11,50
85042 2	Ø 24,5	15,0	2,5	●	15,00
85043 9	Ø 30,0	19,5	5,0	●	25,00



84042

passende  
Buffet-Ständer  
03622, 03623

mit Antirutsch-Füßchen  
non-slip feet  
con pies antideslizantes  
avec pieds antidérapants



# CLASSIC WAVE

designed by EsserDesign



Wellen - Dekor  
wave - decor

Schale, oval „CLASSIC WAVE“  
bowl, oval  
fuente, ovalada  
plat ovale



	cm	cm	ltr.	€
83875 8	27 x 17	4,0	0,80	12,00
83876 5	34 x 21	4,5	1,30	15,50
83877 2	47 x 29	5,0	3,20	23,80



Melamin  
melamine



1 ltr.

83868

tiefer Schwerpunkt  
erhöhte Standfestigkeit

83867

Dressingtopf „CASUAL“  
dressing pot  
salsera alta  
saucière



	cm	cm	ltr.	€
83867 3	Ø 12	21,5	1	24,00
83868 0	Ø 12	21,5	1	24,00

mit Antirutsch-Füßchen  
non-slip feet  
con pies antideslizantes  
avec pieds antidérapants





**Tablett „APART“  
tray  
bandeja  
plateau**



	□ cm	↑ cm	GN	€
83828 4	53,0 x 32,5	2,5	1/1	31,00
83830 7	32,5 x 26,5	2,5	1/2	17,80
83832 1	32,5 x 17,6	2,5	1/3	13,40
83834 5	23,0 x 23,0	2,5		9,80
83836 9	33,0 x 33,0	2,5		19,50
83838 3	53,0 x 53,0	2,5		46,00



**Tablett, rund „APART“  
tray, round  
bandeja, redonda  
plateau rond**



	□ cm	↑ cm	€
83840 6	Ø 37	2,5	31,00

**Einzelteile / spare parts / piezas sueltas / pièces détachées**



Frischhalte-Haube / cover / campana / cloche

06515 4	Ø 33	12,5	5,50
06516 1	Ø 33	12,5	6,50
			mit schwarzem Griff with black handle con botón negro avec bouton noir
06517 8	Ø 33	12,5	6,90
			mit verchromtem Griff with chrom plated handle con botón cromado avec bouton chromé

06515



**Schale, rund „APART“  
bowl, round  
cuenco, redondo  
saladier rond**



	□ cm	↑ cm	ltr.	€
83800 0	Ø 6,5	3,0	0,045	1,30
83802 4	Ø 10,0	4,5	0,13	2,70
83804 8	Ø 15,0	6,5	0,5	6,00
83806 2	Ø 20,0	9,0	1,2	13,60



**Schale „APART“  
bowl  
cuenco  
saladier carré**



	□ cm	↑ cm	ltr.	€
83808 6	6,6 x 6,6	3,0	0,05	1,40
83810 9	10 x 10	4,5	0,17	3,00
83812 3	15 x 15	6,5	0,5	7,20
83814 7	20 x 20	9,0	1,6	17,00
83816 1	25 x 25	9,0	2,6	23,00



**Schale „APART“  
bowl  
cuenco  
saladier carré profond**



	□ cm	↑ cm	ltr.	€
83818 5	25 x 25	12,5	3,8	28,00
83820 8	30 x 30	12,5	4,5	34,50



**Schale „APART“  
bowl  
cuenco  
plat rectangulaire creux**



	□ cm	↑ cm	ltr.	€
83822 2	30 x 15	6,5	1,2	13,00
83824 6	40 x 20	6,5	2,4	25,50



GN2/4

**Schale „APART“  
bowl  
cuenco  
plat rectangulaire allongé**



	□ cm	↑ cm	ltr.	GN	€
83826 0	53,0 x 16,2	6,5	3,0	2/4	21,00



# CASCADE

designed by CULTURE FORM



Gastronorm - Außenmaße  
 Gastronorm - size  
 Gastronorm - medidas exteriores  
 Gastronorme - dimensions extérieures

Das **CASCADE** System  
 The **CASCADE** system  
 El sistema **CASCADE**  
 Le système **CASCADE**

**Tablett kann als Deckel eingesetzt werden!**  
**Tray is also useable as a cover!**  
**¡La bandeja se puede usar como tapa!**  
**Le plat s'utilise aussi comme couvercle!**





Schale „CASCADE“  
bowl  
cuenco  
bol



83960  
GN1/2



83961  
GN2/4



83962  
GN1/4

	cm	↑ cm	GN	ltr.	€
83960 1	32,5 x 26,5	7,5	1/2	3,65	18,00
83961 8	53,0 x 16,2	7,5	2/4	3,65	19,40
83962 5	26,5 x 16,2	7,5	1/4	1,50	9,80
83963 2	28,5 x 25,5	7,5		2,90	17,00



83963  
28,5 x 25,5



83965



83966



83967



83964

Tablett „CASCADE“  
tray  
bandeja  
plat



	cm	↑ cm	matches	GN	€
83965 6	32,5 x 26,5	2,4	83960	1/2	14,80
83966 3	53,0 x 16,2	2,4	83961	2/4	16,00
83967 0	26,5 x 16,2	2,4	83962	1/4	7,40
83964 9	28 x 25	2,4	83963		12,00

Tablett kann als Deckel eingesetzt werden!  
Tray is also useable as a cover!  
¡La bandeja se puede usar como tapa!  
Le plat s'utilise aussi comme couvercle!



rutschfest stapeln

# FLOAT

designed by EsserDesign



- stapelbar mit Löffel und Deckel
- Schalenboden fixiert sich auf dem Deckel
- rutschfest (Antirutschfüßchen)

- with spoon and cover stackable
- non-slip feet

- apilables
- con tapa apilable
- la base se fija a la tapa
- apilado estable (pies anti-deslizantes)

- avec couvercle qui permet un empilage parfait
- le pied du bol supérieur s'encadre dans le couvercle
- antidérapant



**SAN**  
KUNSTSTOFF



**Deckel, transparent, mit Löffelaussparung**  
**cover, transparent, with notched for spoons**  
**tapa transparente, con espacio para la cuchara**  
**couvercle transparent avec encoche pour la louche**



83923



83924

**Tablett GN „FLOAT“  
tray GN  
bandeja GN  
plateau GN**



	cm	↑ cm	GN		€
83923 6	53,0 x 32,5	3	1/1	○	33,00
83925 0	32,5 x 26,5	3	1/2	○	20,00
83924 3	53,0 x 32,5	3	1/1	●	33,00
83926 7	32,5 x 26,5	3	1/2	●	20,00



0,03 ltr. - 1,90 ltr



**Schale, rund „FLOAT“  
bowl, round  
cuenco, redondo  
saladier rond**



	cm	↑ cm	ltr.		€
83900 7	Ø 5,5	3,0	0,03	○	1,50
83902 1	Ø 9,0	4,5	0,15	○	2,60
83904 5	Ø 13,0	6,5	0,45	○	6,30
83906 9	Ø 15,0	7,5	0,70	○	9,20
83908 3	Ø 20,5	10,0	1,90	○	15,80
83901 4	Ø 5,5	3,0	0,03	●	1,50
83903 8	Ø 9,0	4,5	0,15	●	2,60
83905 2	Ø 13,0	6,5	0,45	●	6,30
83907 6	Ø 15,0	7,5	0,70	●	9,20
83909 0	Ø 20,5	10,0	1,90	●	15,80



0,03 ltr. - 4,70 ltr



**Schale „FLOAT“  
bowl  
cuenco  
saladier**



	cm	↑ cm	ltr.		€
83910 6	5,5 x 5,5	3,0	0,03	○	1,50
83912 0	9,0 x 9,0	4,5	0,16	○	3,00
83914 4	12,5 x 12,5	6,0	0,50	○	6,00
83916 8	19 x 19	9,5	1,90	○	14,20
83918 2	25 x 25	12,0	4,70	○	26,00
83911 3	5,5 x 5,5	3,0	0,03	●	1,50
83913 7	9,0 x 9,0	4,5	0,16	●	3,00
83915 1	12,5 x 12,5	6,0	0,50	●	6,00
83917 5	19 x 19	9,5	1,90	●	14,20
83919 9	25 x 25	12,0	4,70	●	26,00



83920



83921  
83922

**Deckel „FLOAT“, mit Löffelaussparung  
cover, with notched for spoons  
tapa, con espacio para la cuchara  
couverture, avec encoche pour la louche**



	cm	↑ cm	matches	€
83920 5	Ø 20,5	1,3	83908, 83909	8,20
83921 2	19 x 19	1,3	83916, 83917	8,20
83922 9	25 x 25	1,3	83918, 83919	10,40



**Buffet-Gestell „FLOAT SMALL“**  
**buffet stand**  
**soporte bufé**  
**support buffet**



Metall verchromt, für 3 Schalen Nr. 83916, 83917  
 metal chrome plated, for 3 bowls no. 83916, 83917  
 metal cromado, para 3 cuencos N° 83916, 83917  
 métal chromé, pour 3 coupelles 83916, 83917

	☐ cm	↑ cm	€
33241 6	55,5 x 19	15,5	37,00



**Buffet-Gestell „FLOAT BIG“**  
**buffet stand**  
**soporte bufé**  
**support buffet**



Metall verchromt, für 3 Schalen Nr. 83914, 83915, für 1 Schale Nr. 83918, 83919  
 metal chrome plated, for 3 bowls no. 83914, 83915, for 1 bowl no. 83918, 83919  
 metal cromado, para 3 cuencos N° 83914, 83915, para 1 cuenco N° 83918, 83919  
 métal chromé, pour 3 coupelles 83914, 83915 ou 1 bol 83918, 83919

	☐ cm	↑ cm	€
33242 3	39 x 39	17	58,00



- vielseitig einsetzbar
- rutschfest

- multi usable
- non-slip

- versátil
- antideslizante

- utilisations multiples
- antidérapant

# PURE



**NEW**

## Schale „PURE“ bowl cuenco bol



weiße Schale mit blauem Rand, hochglänzend, klassischer Emaille-Look  
white bowl with a blue edge, mirror polished finished, classic enamel look  
cuenco blanco con borde azul, pulido brillante, estilo esmalte clásico  
bol blanc avec bord bleu, brillant, émail look classique

84490  
0,02 ltr.



84491  
0,09 ltr.



84492  
0,30 ltr.



84493  
0,45 ltr.



84494  
1,25 ltr.



	□ cm	↑ cm	ltr.	€
84490 2	Ø 5,5	4	0,02	1,70
84491 9	Ø 9,5	4,5	0,09	3,00
84492 6	Ø 13	6,5	0,30	6,60
84493 3	Ø 15	7,5	0,45	10,40
84494 0	Ø 20	10,5	1,25	19,00

# PURE



Tablett „PURE“  
tray  
bandeja  
plat



	▣ cm	↑ cm	GN		€
83401	9 53,0 x 32,5	3	1/1	○	36,50
83480	4 32,5 x 26,5	3	1/2	○	19,00
83481	1 32,5 x 17,6	3	1/3	○	14,20
83588	7 35,4 x 32,5	3	2/3	○	26,80
83482	8 26,5 x 16,2	3	1/4	○	10,50
83433	0 53,0 x 16,2	3	2/4	○	21,00
83882	6 65,0 x 26,5	3		○	39,00
83597	9 40 x 30	3	Bäcker-Maß	○	26,80
83598	6 60 x 20	3	Bäcker-Maß	○	26,80
83599	3 60 x 40	3	Bäcker-Maß	○	55,00
83592	4 40 x 30	3	Bäcker-Maß	●	26,80
83593	1 60 x 20	3	Bäcker-Maß	●	26,80
83594	8 60 x 40	3	Bäcker-Maß	●	55,00
83479	8 53,0 x 32,5	3	1/1	●	36,50
83490	3 32,5 x 26,5	3	1/2	●	19,00
83491	0 32,5 x 17,6	3	1/3	●	14,20
83589	4 35,4 x 32,5	3	2/3	●	26,80
83492	7 26,5 x 16,2	3	1/4	●	10,50
83434	7 53,0 x 16,2	3	2/4	●	21,00



**Tablett, Sushiplatte „PURE“**  
tray  
bandeja  
plateau



	cm	↑ cm		€
83625 9	31,0 x 10,5	2	○	9,00
83417 0	30,0 x 21,0	3	○	13,80
83403 3	35,5 x 18,0	3	○	12,00
83402 6	53,0 x 18,0	3	○	23,80
83626 6	31,0 x 10,5	2	●	9,00
83483 5	53,0 x 18,0	3	●	23,50

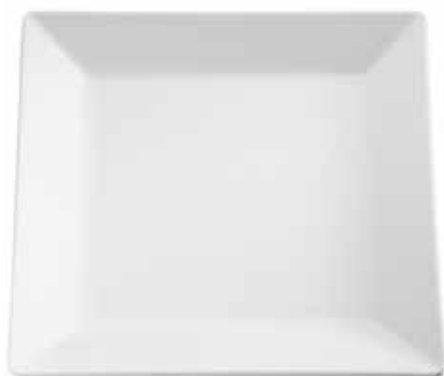

**Tablett quadratisch „PURE“**  
tray square  
bandeja cuadrada  
plateau carré

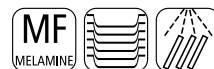

	cm	↑ cm		€
83418 7	18,0 x 18,0	3	○	6,90
83407 1	21,0 x 21,0	3	○	9,60
83406 4	26,5 x 26,5	3	○	14,80
83405 7	37,0 x 37,0	3	○	19,50
83404 0	51,0 x 51,0	3	○	41,50
83400 2	51,0 x 51,0	3	●	41,00



**Tablett / Teller „PURE“**  
tray / plate  
bandeja / plato  
plat / assiette



	cm	↑ cm		€
83884 0	Ø 31	2,5	○	17,80
83869 7	Ø 38	2,5	○	20,00
83886 4	Ø 41	2,5	○	22,40
83484 2	Ø 51	2,5	○	26,50



83412

**Schale / Pastateller „PURE“**  
bowl  
cuenco  
assiette creuse



	cm	↑ cm	ltr.		€
83412 5	Ø 32,0	7,5	1,5	○	16,20
83411 8	Ø 45,5	9,0	1,7	○	45,50



83411  
Ø 45,5 cm



83401  
53,0 x 32,5 cm  
GN1/1



**Schale „PURE“  
bowl  
cuenco  
bol**



	□ cm	↑ cm	litr.		€
83450 7	Ø 5,5	4,0	0,02	○	1,60
83419 4	Ø 9,5	4,5	0,09	○	2,90
83453 8	Ø 13,0	6,5	0,30	○	6,30
83455 2	Ø 15,0	7,5	0,45	○	9,90
83415 6	Ø 20,0	10,5	1,25	○	17,80
83451 4	Ø 5,5	4,0	0,02	●	1,60
83452 1	Ø 9,5	4,5	0,09	●	2,90
83454 5	Ø 13,0	6,5	0,30	●	6,30
83456 9	Ø 15,0	7,5	0,45	●	9,90
83457 6	Ø 20,0	10,5	1,25	●	17,80



**Schale „PURE COLOR“  
bowl  
cuenco  
bol**



	□ cm	↑ cm	litr.		€
83414 9	9,0 x 9,0	4,0	0,14	○	3,40
83410 1	12,5 x 12,5	6,5	0,40	○	5,60
83409 5	19,0 x 19,0	9,0	1,50	○	18,60
83408 8	25,0 x 25,0	12,0	3,80	○	30,00
83466 8	9,0 x 9,0	4,0	0,14	●	3,40
83467 5	12,5 x 12,5	6,5	0,40	●	5,60
83468 2	19,0 x 19,0	9,0	1,50	●	18,60
83469 9	25,0 x 25,0	12,0	3,80	●	30,00
83568 9	9,0 x 9,0	4,0	0,14	●	3,40
83570 2	12,5 x 12,5	6,5	0,40	●	5,60
83572 6	19,0 x 19,0	9,0	1,50	●	18,60
83574 0	25,0 x 25,0	12,0	3,80	●	30,00
83569 6	9,0 x 9,0	4,0	0,14	●	3,40
83571 9	12,5 x 12,5	6,5	0,40	●	5,60
83573 3	19,0 x 19,0	9,0	1,50	●	18,60
83575 7	25,0 x 25,0	12,0	3,80	●	30,00



**Schale „PURE BICOLOR“  
bowl  
cuenco  
bol**



	□ cm	↑ cm	litr.		€
84414 8	9,0 x 9,0	4,0	0,14	◐	3,70
84410 0	12,5 x 12,5	6,5	0,40	◐	6,30
84409 4	19,0 x 19,0	9,0	1,50	◐	20,50
84408 7	25,0 x 25,0	12,0	3,80	◐	31,80
84415 5	9,0 x 9,0	4,0	0,14	◑	3,70
84416 2	12,5 x 12,5	6,5	0,40	◑	6,30
84417 9	19,0 x 19,0	9,0	1,50	◑	20,50
84418 6	25,0 x 25,0	12,0	3,80	◑	31,80
84420 9	9,0 x 9,0	4,0	0,14	◒	3,70
84421 6	12,5 x 12,5	6,5	0,40	◒	6,30
84422 3	19,0 x 19,0	9,0	1,50	◒	20,50
84423 0	25,0 x 25,0	12,0	3,80	◒	32,50





Deckel „PURE“, mit Löffelaussparung  
cover, with notched for spoons  
tapa, con espacio para la cuchara  
couvreclé, avec encoche pour la louche



	cm	cm	matches	€
83600 6	19 x 19	1,5	84410, 84417, 84422, 83409 83572, 83468, 83573, 84429	8,00
83601 3	25 x 25	1,5	84408, 84418, 84423, 83469, 83574, 83575, 83408, 84430	10,50

83600

designed by sieger design



Tablett „FRAMES“  
tray  
bandeja  
plateau



	cm	cm	GN	€
84046 1	53,0 x 32,5	2	1/1	26,00
84047 8	32,5 x 26,5	2	1/2	14,20
84048 5	32,5 x 17,6	2	1/3	10,00

GN1/1 - 1/2 - 1/3



taupe

lemon-grün

Tablett „PURE COLOR“  
tray  
bandeja  
plateau



	cm	cm	GN	€
83560 3	53,0 x 32,5	3	1/1	36,50
83562 7	32,5 x 26,5	3	1/2	19,00
83564 1	53,0 x 18,0	3		23,50
83566 5	35,5 x 18,0	3		12,00
83561 0	53,0 x 32,5	3	1/1	36,50
83563 4	32,5 x 26,5	3	1/2	19,00
83565 8	53,0 x 18,0	3		23,50
83567 2	35,5 x 18,0	3		12,00



Granitoptik

84440  
GN1/1

GN Tablett „PURE GRANIT“  
GN tray  
GN bandeja  
GN plateau



	cm	cm	GN	€
84440 7	53,0 x 32,5	3	1/1	38,00
84441 4	32,5 x 26,5	3	1/2	19,50
84442 1	53,0 x 16,2	3	2/4	21,00

Granitoptik



Schale „PURE GRANIT“  
bowl  
cuenco  
bol



	cm	cm	ltr.	€
84429 2	19 x 19	9	1,5	19,00
84430 8	25 x 25	12	3,8	30,00

1,5 ltr.  
3,8 ltr.



2 Größen  
2 sizes

**Schale „SLATE“  
bowl  
cuenco  
bol**



	cm	cm	litr.	€
<b>NEW</b> 84244 1	19,0 x 19,0	9	1,5	20,00
84245 8	25,0 x 25,0	12	3,8	34,00

**Einzelteile / spare parts / piezas sueltas / pièces détachées**

Deckel „PURE“, mit Löffelaussparung / cover, with notched for spoons / tapa, con espacio para la cuchara / couvercle, avec encoche pour la louche

	cm	cm	passend für / suitable for	€
83600 6	19 x 19	1,5	84244	8,00
83601 3	25 x 25	1,5	84245	10,50



83497  
0,8 ltr.



83498  
1,5 ltr.



83499  
2,4 ltr.

**Schale „PURE“  
bowl  
cuenco  
bol**



	cm	cm	litr.	€
83497 2	22,5 x 15,5	7,5	0,8	17,40
83498 9	38,5 x 15,5	7,5	1,5	28,50
83499 6	51,0 x 15,5	7,5	2,4	37,50



**Tablett „PURE“  
tray  
bandeja  
plat**



Edelstahl matt poliert, passend für Melamin-Schalen 83414 oder 83466  
stainless steel satin polished finish, for melamin bowls 83414 or 83466  
acero inoxidable mate, apta para cuencos de melamina 83414 o 83466  
inox mat, concient pour bols mélamine 83414 et 83466

	cm		€
30120 7	20 x 11	<b>für 2 Schalen</b> / for 2 bowls para 2 cuencos / pour 2 bols	6,40
30122 1	20 x 20	<b>für 4 Schalen</b> / for 4 bowls para 4 cuencos / pour 4 bols	10,50
30121 4	29 x 20	<b>für 6 Schalen</b> / for 6 bowls para 6 cuencos / pour 6 bols	13,20





**Menage „PURE“  
menage  
conjunto aperitivo  
set apéritif**



5-teilig: 1 Ständer, Edelstahl matt poliert + 4 Melamin-Schalen, weiß (Nr. 83414)  
 5 pcs. set: 1 stainless stand satin polished finish + 4 square white bowls (No. 83414)  
 5 unidades: 1 soporte, acero inoxidable mate + 4 cuencos de melamina blancos redondos (N° 83414)  
 5 pièces: 1 support inox mat + 4 coupelles rondes mélamine blanche (ref. 83414)

	☐ cm	↑ cm	€
09923 4	17 x 17	16	26,00



**Menage „PURE“  
menage  
conjunto aperitivo  
set apéritif**



4-teilig: 1 Ständer, Edelstahl matt poliert + 3 Melamin-Schalen, weiß (Nr. 83419)  
 4 pcs. set: 1 stainless stand satin polished finish + 3 white bowls (No. 83419)  
 4 unidades: 1 soporte, acero inoxidable mate + 3 cuencos de melamina blancos redondos (N° 83419)  
 4 pièces: 1 support inox mat + 3 coupelles rondes mélamine blanche (ref. 83419)

	☐ cm	↑ cm	€
09924 1	14 x 14	16	23,00

**drehbar /  
schwenkbar**



**Serviergestell „FLEXIBEL“  
serving stand  
expositor  
présentoir**



3-stufig „beweglich / drehbar“, platzsparend zerlegbar  
 3 tier, flexible frame, space saving  
 3 alturas, marco flexible, ahorra espacio  
 3 hauteurs, cadre souple, gagne de la place

	☐ cm	↑ cm	€
33243 0	45,5 x 32	21,5	46,00

**passende Tablett  
83403, 83566 und 83567**



**Serviergestell „S-PURE“  
serving stand  
soporte bufé  
support buffet**



für 3 Tablett **quadratisch** 83407 oder 83418  
 for 3 trays **square** 83407 or 83418  
 para 3 bandejas **cuadradas** 83407 o 83418  
 pour 3 plats **carrés** 83407 ou 83418

	☐ cm	↑ cm	€
33226 3	29 x 17	41	38,00

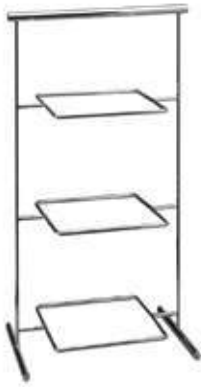

**Serviergestell „M-PURE“**  
**servicing stand**  
**soporte bufé**  
**support buffet**



für 3 Tablett **quadratisch** 83406 oder 83407  
 for 3 trays **square** 83406 or 83407  
 para 3 bandejas **cuadradas** 83406 o 83407  
 pour 3 plats **carrés** 83406 o 83407

	□ cm	↑ cm	matches	€
33227 0	33 x 21	44	83406, 83407	46,00



**Serviergestell „L-PURE“**  
**servicing stand**  
**soporte bufé**  
**support buffet**



für 3 Tablett **rechteckig** 83417  
 for 3 trays **rectangular** 83417  
 para 3 bandejas **rectangulares** 83417  
 pour 3 plats **rectangulaires** 83417

	□ cm	↑ cm	matches	€
33228 7	37 x 21	44	83417	50,00

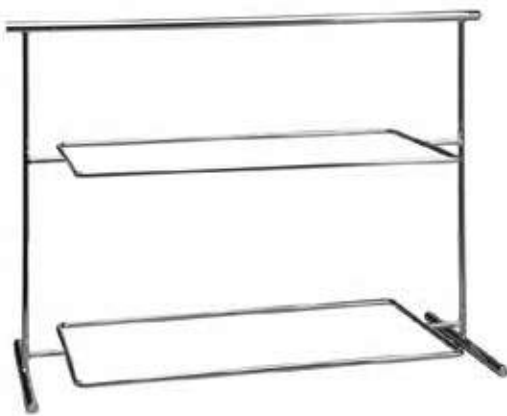

**Serviergestell GN „XL-PURE“**  
**servicing stand GN**  
**soporte bufé GN**  
**support buffet GN**



Passend für Tablett PURE GN1/1, GN1/2, GN1/3, GN2/4  
 suitable for tray GN1/1, GN1/2, GN1/3, GN2/4  
 aptas para bandejas GN1/1, GN1/2, GN1/3, GN2/4  
 convient pour les plats GN1/1, GN1/2, GN1/3, GN2/4

passend für GN1/1 - GN1/2  
 GN1/3 - GN2/4

	□ cm	↑ cm	matches	€
33222 5	63 x 27	44,5	all PURE GN-trays	65,00

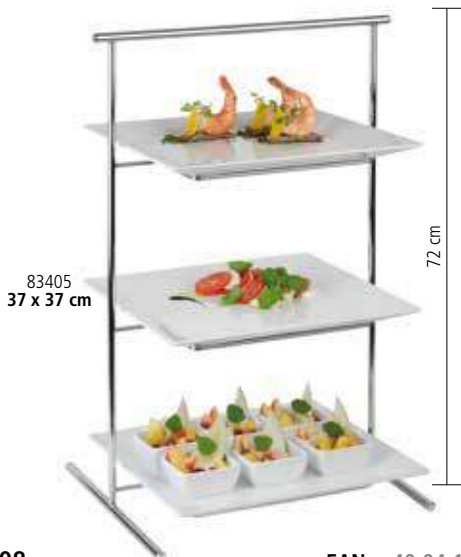

**Serviergestell „XXL-PURE“**  
**servicing stand**  
**soporte bufé**  
**support buffet**



für 3 Tablett **quadratisch** 83405 (37 x 37 cm)  
 for 3 trays **square** 83405 (37 x 37 cm)  
 para 3 bandejas **cuadradas** 83405 (37 x 37 cm)  
 pour 3 plats **carrés** 83405 (37 x 37 cm)

	□ cm	↑ cm	matches	€
33234 8	45 x 37	72	83405	105,00

# BASKET

designed by CULTURE FORM



Gastronorm - Außenmaße  
Gastronorm - size  
Gastronorm - medidas exteriores  
Gastronorme - dimensions extérieures



stapelbar  
stackable



84000  
GN1/2



84004  
GN1/4



84003  
GN2/4

Schale „BASKET“  
bowl  
cuenco  
bol



	□ cm	↑ cm	GN	litr.		€
84000 3	32,5 x 26,5	8,5	1/2	3,50	○	18,50
84002 7	53,5 x 16,2	8,5	2/4	3,20	○	22,00
84004 1	26,5 x 16,2	8,5	1/4	1,40	○	9,00
84006 5	25,0 x 25,0	10		2,80	○	16,20
84001 0	32,5 x 26,5	8,5	1/2	3,50	●	18,50
84003 4	53,5 x 16,2	8,5	2/4	3,20	●	22,00
84005 8	26,5 x 16,2	8,5	1/4	1,40	●	9,00
84007 2	25,0 x 25,0	10		2,80	●	16,20

# NATURAL COLLECTION



## Blattschale „NATURAL COLLECTION“ leaf fuente en forma de hoja plat feuille



84083, 84086



84084, 84087

	cm	cm		€
84083 6	40 x 18,5	3,5	○	14,80
84086 7	52 x 25,0	4,0	○	18,40
84084 3	40 x 18,5	3,5	●	14,80
84087 4	52 x 25,0	4,0	●	18,40
84085 0	40 x 18,5	3,5	●	14,80
84088 1	52 x 25,0	4,0	●	18,40



84085, 84088

## Palmbattschale „NATURAL COLLECTION“ bowl fuente en forma de hoja de palmera plat feuille de palme



84080



84081



84082

	cm	cm	litr.		€
84080 5	40 x 18,5	10	1,8	○	23,00
84081 2	40 x 18,5	10	1,8	●	23,00
84082 9	40 x 18,5	10	1,8	●	23,00

stapelbar, mit Löffelablage  
stackable, for spoons  
apilable, práctico para cubiertos de servicio  
empilable, pratique pour déposer les couverts





83864



83863



83862

**Blattschale „NATURAL COLLECTION“**  
leaf  
fuente en forma de hoja  
plat feuille



	cm	↑ cm		€
83864 2	34,5 x 8	2,5	○	9,50
83863 5	34,5 x 8	2,5	●	9,50
83862 8	34,5 x 8	2,5	●	9,50



**Blattschale „NATURAL COLLECTION“**  
leaf  
fuente en forma de hoja  
plat feuille



	cm	↑ cm		€
83435 4	36 x 16	3,0	○	12,00
83438 5	45 x 24	3,0	○	16,00
83441 5	53 x 29	3,5	○	18,40
83436 1	36 x 16	3,0	●	12,00
83439 2	45 x 24	3,0	●	16,00
83442 2	53 x 29	3,5	●	18,40
83437 8	36 x 16	3,0	●	12,00
83440 8	45 x 24	3,0	●	16,00
83443 9	53 x 29	3,5	●	18,40



**Palmbattschale „NATURAL COLLECTION“**  
tray  
fuente en forma de hoja de palmera  
plat feuille de palme



	cm	↑ cm		€
83871 0	27 x 27	4,5	○	14,80
83444 6	35 x 34	4,5	○	18,40
83873 4	42 x 42	4,5	○	28,40
83872 7	27 x 27	4,5	●	14,80
83445 3	35 x 34	4,5	●	18,40
83874 1	42 x 42	4,5	●	28,40
83865 9	27 x 27	4,5	●	14,80
83446 0	35 x 34	4,5	●	18,40
83866 6	42 x 42	4,5	●	28,40



**Palmbattschale „NATURAL COLLECTION“**  
bowl  
fuente en forma de hoja de palmera  
plat feuille de palme



	cm	↑ cm	ltr.		€
83447 7	∅ 30	10,0	1,5	○	16,00
83896 3	∅ 35	12,5	4,5	○	35,70
83448 4	∅ 30	10,0	1,5	●	16,00
83895 6	∅ 35	12,5	4,5	●	35,70
83449 1	∅ 30	10,0	1,5	●	16,00
83894 9	∅ 35	12,5	4,5	●	35,70

# CASUAL



2 Größen  
2 sizes

Schälchen „CASUAL MINI“  
bowl  
cuenco  
bol mini



	cm	cm	litr.		€
83880 2	Ø 6,0	2,5	0,02	○	1,50
83881 9	Ø 7,5	3,5	0,05	○	1,90



5 Größen  
5 sizes

Schale „CASUAL MAXI“  
bowl  
cuenco  
bol



	cm	cm	litr.		€
83696 9	Ø 10	4,5	0,15	○	2,60
83698 3	Ø 12	5,5	0,25	○	3,20
83700 3	Ø 14	6,5	0,50	○	3,80
83704 1	Ø 20	9,2	1,80	○	7,90
83702 7	Ø 23	10,5	2,50	○	9,00
83697 6	Ø 10	4,5	0,15	●	2,60
83699 0	Ø 12	5,5	0,25	●	3,20
83701 0	Ø 14	6,5	0,50	●	3,80
83705 8	Ø 20	9,2	1,80	●	7,90
83703 4	Ø 23	10,5	2,50	●	9,00



passender Ø 20 cm Deckel 83920  
für Schalen 83704 und 83705



6 Größen  
6 sizes

Dip-Schälchen „CASUAL“  
bowl  
cuencos para salsas  
ramequin



	cm	cm	litr.		€
83780 5	Ø 6,0	3,7	0,04	○	0,80
83781 2	Ø 7,0	3,7	0,05	○	1,10
83782 9	Ø 7,8	4,0	0,08	○	1,40
83783 6	Ø 8,5	4,5	0,11	○	1,50
83784 3	Ø 9,8	4,5	0,14	○	1,80
83798 0	Ø 6,0	3,7	0,04	●	1,00
83777 5	Ø 6,0	3,5	0,03	●	1,00







**Serviergestell „CASUAL“**  
**servicing stand**  
**expositor**  
**présentoir**

ohne Schalen / Körbe  
 without bowls / baskets  
 sin cuencos / cestas  
 sans bols / corbeilles



83705 oder 83704  
 Schale - Ø 20 cm



33245  
 Gestell  
 4 x Ø 20 cm

	cm	cm		€
33245 4	Ø 48	49	4 x Ø 20	74,00

designed by **ElbeEichhorn**



**Schale "MULTI"**  
**bowl**  
**cuenco**  
**bol**



inklusive 3 herausnehmbare Trennwände, 4 Kammern  
 including 3 removable divider, 4 chambers  
 con 3 divisores extraíbles, 4 compartimentos  
 avec 3 parois de séparation amovibles, 4 compartiments



84531



	cm	cm	litr.		€
84531 2	31,5 x 17,5	7	2,1	○ white	19,00
84532 9	31,5 x 17,5	7	2,1	● anthrazit	19,00

**Einzelteile / spare parts / piezas sueltas / pièces détachées**

Trenner, 6er Set / divider, 6 pcs. / divisor, 6 pz. / paroi de séparation, 6 pc.

	cm	mm	pcs.		€
84533 6	16,5 x 5	3,5	6	○ white	6,90
84534 3	16,5 x 5	3,5	6	● anthrazit	6,90



84532

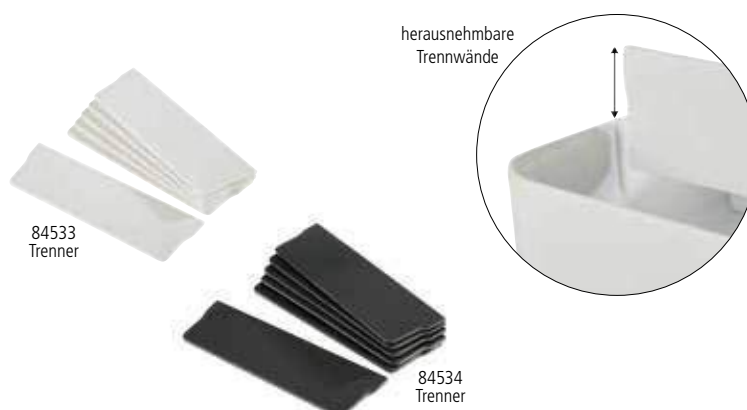

84533  
 Trenner

herausnehmbare  
 Trennwände

84534  
 Trenner

**Etagère „CASUAL“**  
 etagère  
 expositor de bombones o bocaditos  
 présentoir à mignardises



**einsteckbares  
 Edelstahlschild,  
 beschriftbar  
 (Schild ist nicht  
 beschriftet)**



inkl. Schild  
 incl. sign  
 placa incluida, sin inscripción  
 étiquette incluse, sans inscription

	□ cm	↑ cm		€
34248 4	Ø 31 - 41 - 51	55	3-stufig / 3-tier 3 niveles / 3 étages	109,00
34247 7	Ø 31 - 41	35	2-stufig / 2-tier 2 niveles / 2 étages	66,00



**3-stufig / 3-tier**



**2-stufig / 2-tier**



**Fischplatte „CASUAL“**  
 fish platter  
 fuente pescado  
 plat à poisson



	□ cm	↑ cm		€
83995 3	28,0 x 17,0	2,5		9,80
83997 7	48,0 x 22,5	2,5		14,50



**0,6 ltr.  
 1,2 ltr.**

**Fischschale „CASUAL“**  
 fish bowl  
 cuenco para pescado  
 plat creux à poisson



	□ cm	↑ cm	ltr.	€
83991 5	24 x 27	5,5	0,6	14,50
83993 9	30 x 35	7,5	1,2	23,00

**Fischplatte „BIG“**  
**fish plate**  
**fuelle para pescado**  
**plat creux à poisson**



	cm	↑ cm	ltr.	€
83996 0	58,5 x 28,0	5,5	2,0	28,00



**Tablett / Sushiboard**  
**sushi board**  
**bandeja para sushi**  
**plateau sushi**



	cm	↑ cm		€
84980 8	24,0 x 10,5	2,5	○	4,20
84981 5	24,0 x 10,5	2,5	●	4,20



84980

**Schale „LEAF“**  
**bowl**  
**cuenco**  
**bol**



	cm	↑ cm	ltr.	€
84200 7	42,0 x 19,5	6,5	1,0	11,00
84202 1	50,0 x 23,0	7,5	1,5	16,80



designed by EsserDesign

**Schale „SCANTIC“**  
**bowl**  
**cuenco**  
**bol**



	cm	↑ cm	ltr.	€
84221 2	26,5 x 10,5	6,5	1,0	9,60
84222 9	53,0 x 10,5	6,5	2,0	18,20



84221

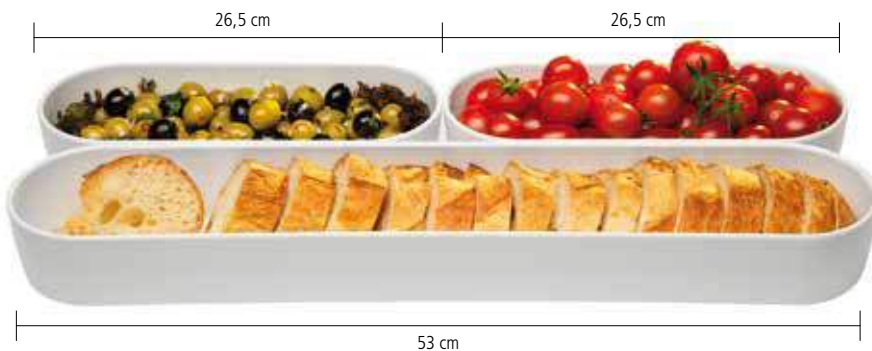



**Schale „CASUAL“  
bowl  
cuenco  
bol**



	□ cm	↑ cm	litr.	€
84215 1	Ø 10	6,5 / 8,5	0,2	4,80
84216 8	Ø 12	7,5 / 9,5	0,3	6,20

84215

84216

**Dipschale „CASUAL“  
bowl  
cuenco  
plateau**



	□ cm	↑ cm	€
84220 5	29,0 x 9,0	3,0	6,60



83878

83879

**Fingerfood-Teller „FLYING BUFFET“  
plate  
plato  
assiette**



	□ cm	↑ cm		€
83878 9	9,5 x 9,5	1,5 / 3,5	○	3,20
83879 6	9,5 x 9,5	1,5 / 3,5	●	3,20

**Einzelteile / spare parts / piezas sueltas / pièces détachées**

Edelstahl Tablett / stainless steel platter / bandeja / plateau	€
11119 6 53 x 32,5	28,00

Tablett „APART“ / tray / bandeja / plateau	€
83828 4 53,0 x 32,5 2,5	31,00

Schale „FLOAT“ / bowl / cuenco / saladier	€
83912 0 9,0 x 9,0 4,5 ○ 0,16	3,00

Schale „FLOAT“ / bowl / cuenco / saladier	€
83913 7 9,0 x 9,0 4,5 ● 0,16	3,00

**passend für 15 Fingerfoodteller  
oder 15 Schalen (83912 oder 83913)**



11119  
Edelstahl Tablett  
GN1/1

11119  
stainless tray  
GN1/1



83828  
Melamin Tablett  
GN1/1

83828  
melamin tray  
GN1/1

designed by EsserDesign

**Schale „ORGANIC“  
bowl  
cuenco  
bol**



	□ cm	↑ cm	ltr.		€
84235 9	32,5 x 17	5,5	1,0	○	8,60
84236 6	50,0 x 26	6,5	3,5	○	24,00
84237 3	32,5 x 17	5,5	1,0	●	8,60
84238 0	50,0 x 26	6,5	3,5	●	24,00



84235



84238

Melamin  
melamine

designed by EsserDesign

**Schale „BIG WAVE“  
bowl  
cuenco  
bol**



	□ cm	↑ cm	ltr.	€
83587 0	33,0 x 24,0	8,5	1	18,20



**Schale  
bowl  
cuenco  
bol**



	□ cm	↑ cm	ltr.	€
84028 7	21,0 x 14,5	9	0,45	7,90
84029 4	26,5 x 16,5	12	0,80	9,90



0,45 und 0,80 Liter

designed by **CULTURE FORM**

**NEW**

**Besteck-Ablage „SPOON“**  
cutlery rest  
reposa cuchara  
pose-cuillère



	cm	cm		€
83801 7	26 x 10,5	5	○	6,00



designed by **CULTURE FORM**

**NEW**

**Besteck-Ablage „BOWL“**  
cutlery rest  
reposa cuchara  
pose-cuillère



	cm	cm	ltr.		€
83803 1	22,5 x 11	6	0,5	○	6,40



**Besteck-Ablage „SMALL WAVE“**  
cutlery rest  
reposa cuchara  
pose-cuillère



mit rutschfestem Boden  
with non-slip bottom  
con pies antideslizantes  
avec pieds antidérapants

	cm	cm		€
83897 0	26 x 13	4,5		8,90



**Tablett „GOURMET“**  
tray  
bandeja  
plateau



mit 3 Absätzen Ø 4 cm  
with 3 holes Ø 4 cm  
con 3 agujeros Ø 4 cm  
avec 3 trous Ø 4 cm

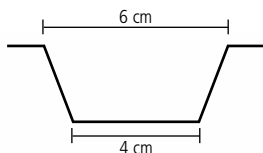

	□ cm	↑ cm		€
84017 1	30,5 x 9,5	2,5		7,60



**Schälchen „GOURMET“**  
bowl  
cuenco  
bol



	□ cm	↑ cm	ml	€
84018 8	Ø 7	6	50	2,00

passend für Tablett  
„Gourmet“  
Nr. 84017

designed by **CULTURE FORM**

**Serviertablett „KAFFEEHAUS“**  
tray  
bandeja  
plateau



rutschfeste Oberfläche  
non-slip surface  
superficie antideslizante  
surface antidérapante

	□ cm	↑ cm		€
84250 2	26,0 x 20,0	1,5	○	4,20
84252 6	28,5 x 21,5	1,5	○	4,80
84251 9	26,0 x 20,0	1,5	●	4,20
84253 3	28,5 x 21,5	1,5	●	4,80





**Tortenplatte**  
**cake tray**  
**bandeja para tarta**  
**plat à tarte**

Rand fixiert die Haube, mit Antirutsch-Füßchen  
 carved edge fixes the cover, non-slip feet  
 ranura para fijar bien la campana, pies antideslizantes  
 bord rainuré pour maintenir ferme la cloche, pieds antiglisse



	□ cm	↑ cm		€
00468 9	Ø 31	4	○	15,00
00469 6	Ø 31	4	●	15,00

**Einzelteile / spare parts / piezas sueltas / pièces détachées**



Frischhalte-Haube / cover / campana / cloche

06510 9	Ø 30	11,5		4,40
06511 6	Ø 30	11,5	mit schwarzem Griff with black handle con botón negro avec bouton noir	5,50
06512 3	Ø 30	11,5	mit verchromtem Griff with chrom plated handle con botón cromado avec bouton chromé	5,90



**Servierplatte**  
**plate**  
**bandeja para servir**  
**plat de service**

mit Antirutsch-Füßchen  
 non-slip feet  
 con pies antideslizantes  
 avec pieds antidérapants



	□ cm	↑ cm		€
83869 7	Ø 38	2,5	○	20,00

**Einzelteile / spare parts / piezas sueltas / pièces détachées**



Rolltop-Haube / rolltop cover / campana abatible / cloche basculante

18388 9	Ø 38	20	mit verchromtem Kugelgriff with chrome plated handle con pomo cromado avec bouton chromé	19,40
---------	------	----	---	-------







83890

↑ 8 cm



83891

↑ 16 cm

**Servier- und Tortenplatte „CASUAL“**  
 cake plate  
 porta pasteles  
 présentoir à gâteaux



	cm	cm	€
83890 1	Ø 31	8	24,00
83891 8	Ø 31	16	30,00



83890



83892

↑ 8 cm



83893

↑ 16 cm

**Servier- und Tortenplatte „CASUAL“**  
 cake plate  
 porta pasteles  
 présentoir à gâteaux



	cm	cm	€
83892 5	31 x 31	8	27,00
83893 2	31 x 31	16	32,50



83893

designed by sieger design



GN 1/1 - 1/2 - 1/3

84046

**Tablett „FRAMES“**  
 tray  
 bandeja  
 plateau



	cm	cm	GN	€
84046 1	53,0 x 32,5	2	1/1	26,00
84047 8	32,5 x 26,5	2	1/2	14,20
84048 5	32,5 x 17,6	2	1/3	10,00

**Eierbecher, 4er Set**  
**egg holder, 4 pcs. set**  
**huevera, set de 4 unidades**  
**coquetier, pack de 4**



	□ cm	↑ cm	pcs.	€
83851 2	Ø 8	3	4	6,40

**Eierbecher, 4er Set**  
**egg holder, 4 pcs. set**  
**huevera, set de 4 unidades**  
**coquetier, pack de 4**



	□ cm	↑ cm	pcs.	€
83848 2	Ø 8,5	2	4	5,90

**Teller, rund „CASUAL“**  
**plate, round**  
**plato redondo**  
**assiette ronde**



	□ cm	↑ cm		€
83500 9	Ø 22,5	2,5		7,00
83514 6	Ø 26,5	2,5		8,40

**Kaffeebecher „CASUAL“**  
**coffee cup**  
**taza de café**  
**tasse à café**



	□ cm	↑ cm	ltr.	€
83513 9	Ø 9,5	10	0,4	5,90

# „MINI“

NEW



84452



84450



84454



84456



84458

## Schale „MINI“ bowl cuenco bol



	□ cm	↑ cm	ltr.		€
84450 6	7,5 x 7,0	4,5	0,05	○	1,40
84452 0	11,5 x 7,5	3	0,06	○	1,40
84454 4	11,5 x 6,0	5,5	0,04	○	1,40
84456 8	8,5 x 7,0	6	0,07	○	1,40
84458 2	8,0 x 8,0	4	0,10	○	1,40
84460 5	35,0 x 4,5	3	0,20	○	2,40



84460



84315



84317



84218

## Schale „MINI“ bowl cuenco bol



	□ cm	↑ cm	ltr.		€
84315 8	∅ 8,5	3,5	0,05	● white/mint	3,20
84317 2	∅ 8,5	3,5	0,05	● white/yellow	3,20
84218 2	∅ 8,5	3,5	0,05	● black/white	3,20

## Schale „MINI“ bowl cuenco bol



84312



84314



84217

	□ cm	↑ cm	ltr.		€
84312 7	∅ 8,0	4,0	0,1	● white/mint	3,20
84314 1	∅ 8,0	4,0	0,1	● white/yellow	3,20
84217 5	∅ 8,0	4,0	0,1	● black/white	3,20

# FINGERFOOD LÖFFEL

PARTY SPOON / CUCHARA PARTY / CUIILLÈRE PARTY



Löffel „HALFTONE“  
spoon  
cuchara  
cuillère

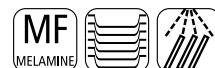

	□ cm	↑ cm	●		€
84158 1	Ø 5,5	7,0	●	white / black	3,00



84128

Fingerfood Löffel „BOAT“  
party spoon  
cuchara party  
cuillère party



	□ cm	↑ cm	●		€
84128 4	14,5 x 4,5	4,5	●	white / black	3,00
84140 6	14,5 x 4,5	4,5	○	white	2,90
84141 3	14,5 x 4,5	4,5	●	black	2,90
84142 0	14,5 x 4,5	4,5	●	lemon-green	2,90
84143 7	14,5 x 4,5	4,5	●	mint	2,90

84143

84142

84140

84141

84128



**Fingerfood-Löffel „HONG KONG“**  
party spoon  
cuchara party  
cuillère party



	☐ cm	↑ cm		€
83486 6	13 x 4,5	4,5	○	1,20
83487 3	13 x 4,5	4,5	●	1,20
83424 8	13 x 4,5	4,5	●	1,20
83426 2	13 x 4,5	4,5	●	1,20

designed by EsserDesign



**Fingerfood-Löffel „MING HING“**  
party spoon  
cuchara party  
cuillère party



	☐ cm	↑ cm		€
83842 0	11 x 4,5	4	○	1,10
83843 7	11 x 4,5	4	●	1,10

designed by EsserDesign



**Fingerfood-Löffel „YING YANG“**  
party spoon  
cuchara party  
cuillère party



	☐ cm	↑ cm		€
83844 4	10 x 4,5	1,5	○	1,10
83845 1	10 x 4,5	1,5	●	1,10

designed by **formel<sup>23</sup>**  
PRODUKTDESIGN



**Fingerfood-Löffel „LEAF“**  
party spoon  
cuchara party  
cuillère party



	☐ cm	↑ cm		€
83887 1	10 x 4,5	1,5	○	1,80
83888 8	10 x 4,5	1,5	●	1,80
83889 5	10 x 4,5	1,5	●	1,80

# SYSTEM-THEKE designed by CULTURE FORM

professionelle Lebensmittelpräsentation

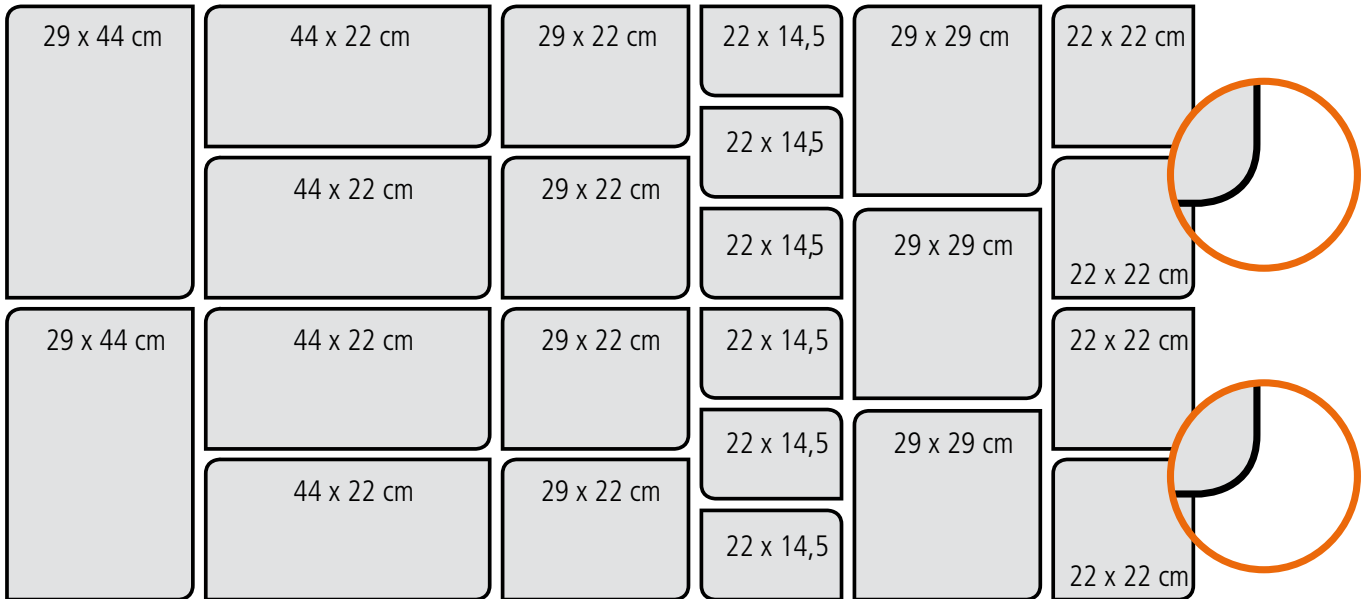

Das System umfasst 34 Schalen und Platten in den Farben schwarz und weiß. Passend zu den Schalen sind 5 transparente Deckel im Angebot. Die Vorteile: Ein flexibles Baukastensystem für Thekentiefen 70 bis 90 cm. Keine Lücken in der Theke, variable Füllmengen und einheitliche Optik. Ein größerer Radius ermöglicht ein einfaches Handling, die Elemente lassen sich leicht aus der Theke nehmen, mit Stapelnocke.

System consists of 34 bowls and trays each in black and white colour. Properly to the bowls 5 transparent covers are available. Advantages: flexible modular system for counter depth 70 to 90 cm, no gap inside the counter, variable filling quantities, uniform design. The stable edge allows an easy and fast stackle and therefore no scratching or jamming of the bowls.

El sistema para mostradores de alimentación consiste en 34 bandejas y cuencos disponibles en blanco y negro, con 5 modelos distintos de tapas transparentes. Todo son ventajas. El sistema permite combinaciones flexibles para mostradores de 70 a 90 cm de profundidad, sin huecos en el mostrador, con capacidades variables y con un diseño elegante y uniforme. Las esquinas dejan el espacio suficiente para que se puedan quitar y poner los recipientes con fácil manejo, sin roces ni ralladuras.

Ce système élégant et pratique de présentation pour vitrines d'alimentation comprend 34 références de plats et bols en noir et en blanc. Et 5 couvercles transparents. Avantages: système modulaire flexible pour comptoirs prof. 70-90 cm, sans espaces vides et en même temps commodité de préhension grâce à la forme des angles des récipients, pour les retirer ou remettre facilement.

**Baukasten-System**



**„SYSTEM-THEKE“**  
System-counter  
Sistema para mostrador  
Système-Comptoir



Tablett 84050, 84062, 84066, 84069



**quadratisch  
und  
rechteckig**



Tablett 84150, 84162, 84166, 84169



**rechteckig  
und  
quadratisch**



84068

	□ cm	↑ cm	ltr.		€
84050	8 22 x 14,5	2	-	○	4,40
84051	5 22 x 14,5	4	0,7	○	5,40
84052	2 22 x 14,5	6	1,0	○	6,50
84053	9 22 x 14,5	9	1,7	○	8,80
84055	3 22 x 22,0	4	1,0	○	7,80
84056	0 22 x 22,0	6	1,8	○	8,80
84057	7 22 x 22,0	9	3,0	○	11,00
84073	7 28 x 21,0	4	1,5	○	8,40
84059	1 29 x 22,0	4	1,3	○	10,00
84060	7 29 x 22,0	6	2,1	○	11,00
84062	1 29 x 29,0	2	-	○	9,40
84063	8 29 x 29,0	4	1,5	○	11,00
84064	5 29 x 29,0	6	3,0	○	13,50
84076	8 42 x 28,0	4	3,0	○	14,50
84066	9 44 x 22,0	2	-	○	12,50
84067	6 44 x 22,0	4	2,0	○	14,50
84069	0 44 x 29,0	2	-	○	15,50
84150	5 22 x 14,5	2	-	●	4,40
84151	2 22 x 14,5	4	0,7	●	5,40
84152	9 22 x 14,5	6	1,0	●	6,50
84153	6 22 x 14,5	9	1,7	●	8,80
84155	0 22 x 22,0	4	1,0	●	7,80
84156	7 22 x 22,0	6	1,8	●	8,80
84157	4 22 x 22,0	9	3,0	●	11,00
84173	4 28 x 21,0	4	1,5	●	8,40
84159	8 29 x 22,0	4	1,3	●	10,00
84160	4 29 x 22,0	6	2,1	●	11,00
84162	8 29 x 29,0	2	-	●	9,40
84163	5 29 x 29,0	4	1,5	●	11,00
84164	2 29 x 29,0	6	3,0	●	13,50
84176	5 42 x 28,0	4	3,0	●	14,50
84166	6 44 x 22,0	2	-	●	12,50
84167	3 44 x 22,0	4	2,0	●	14,50
84169	7 44 x 29,0	2	-	●	15,50

**Deckel transparent, mit Löffelussparung**  
**cover, transparent, with notched for spoons**  
**tapa transparente, con espacio para la cuchara**  
**couvercle transparent avec encoche pour la cuillère**



		matches	
84054	6 22 x 14,5	84050-84053, 84150-84153	6,50
84058	4 22 x 22,0	84055-84057, 84155-84157	8,40
84061	4 29 x 22,0	84059-84060, 84159-84160	9,50
84065	2 29 x 29,0	84062-84064, 84162-84164	12,50
84068	3 44 x 22,0	84066-84067, 84166-84167	13,50

# GASTRONORMBEHÄLTER

GASTRONORM-CONTAINER / FUENTE GASTRONORM / BACS GASTRONORME

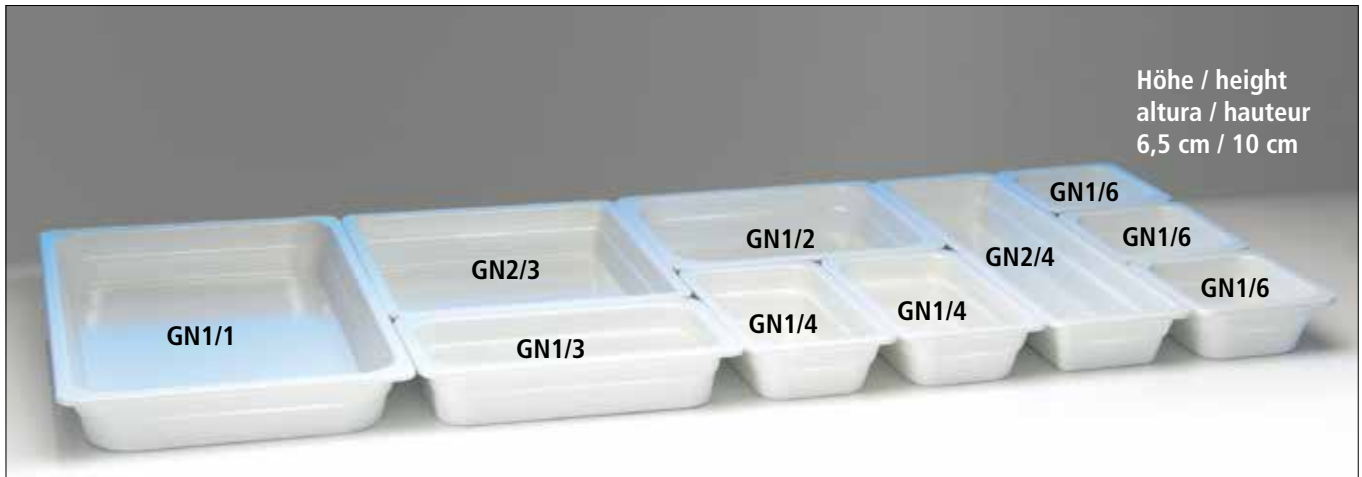

- Melamin, weiß
- mit Stapelnocke
- superleichtes Stapeln und Entstapeln

- melamin, white
- with notching edge
- clean ladling and pouring
- not recommend in cookware

- melamina, blanco
- con borde para apilamiento
- muy fáciles de apilar y desapilar
- no recomendado para su uso en marmitas u ollas

- mélamine, blanc
- usage non recommandé pour marmites ou casseroles
- encoche pour une louche
- facil à empiler et déempiler



**GN-Behälter „HIGHLINE“**  
**GN-container**  
**cubetas GN**  
**bac GN**



extrem bruchsticher, glänzende und harte Oberfläche, tiefkühlfest, keinen Temperaturschocks unterziehen, nicht auf heißen Flächen liegen lassen - weiß

durable, top quality, hard and glossy surface, avoid thermal shocks, do not leave on hot surfaces - white

duradera, alta calidad, superficie brillante y resistente, hay que evitar los cambios térmicos bruscos, no apoyar en superficies calientes

durable, haute qualité, surface brillante et résistante, éviter les chocs thermiques et ne pas poser sur une surface chaude

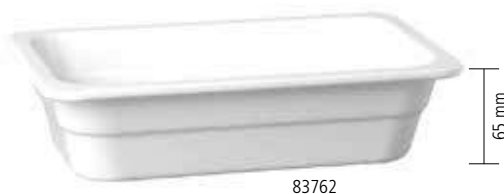

83762



83763

	cm	mm	GN	ltr.	€
83772 0	53,0 x 32,5	65	1/1	7,10	36,00
83770 6	35,0 x 32,5	65	2/3	4,60	32,50
83768 3	32,5 x 26,5	65	1/2	3,40	20,00
83766 9	53,0 x 16,2	65	2/4	3,00	23,50
83764 5	32,5 x 17,6	65	1/3	2,00	15,50
83762 1	26,5 x 16,2	65	1/4	1,35	14,50
83760 7	17,6 x 16,2	65	1/6	0,80	11,00
83773 7	53,0 x 32,5	100	1/1	11,0	41,00
83769 0	32,5 x 26,5	100	1/2	5,50	23,40
83765 2	32,5 x 17,6	100	1/3	3,15	18,00
83763 8	26,5 x 16,2	100	1/4	2,20	16,00
83761 4	17,6 x 16,2	100	1/6	1,25	12,40



**HOT  
PRICE**

**GN-Behälter „ECOLINE“**  
GN container  
cubeta GN superior  
bac GN supérieur



mit Stapelnocke  
with notching edge  
con borde marcado para el apilado  
avec rebord pour l'empilage



GN1/1  
83759 65 mm  
84300 100 mm



GN1/2  
83756 65 mm  
84307 100 mm



GN2/4  
83755 65 mm  
84302 100 mm



GN1/3  
83752 65 mm  
84309 100 mm



GN1/4  
83751 65 mm  
84304 100 mm



GN1/6  
83748 65 mm  
84311 100 mm

	cm	mm	GN	ltr.		€
83759 1	53,0 x 32,5	65	1/1	7,10	○	28,00
83757 7	32,5 x 26,5	65	1/2	3,40	○	15,80
83755 3	53,0 x 16,2	65	2/4	3,00	○	19,00
83753 9	32,5 x 17,6	65	1/3	2,00	○	13,80
83751 5	26,5 x 16,2	65	1/4	1,35	○	12,50
83749 2	17,6 x 16,2	65	1/6	0,80	○	10,00
83758 4	53,0 x 32,5	65	1/1	7,10	●	28,00
83756 0	32,5 x 26,5	65	1/2	3,40	●	15,80
83754 6	53,0 x 16,2	65	2/4	3,00	●	19,00
83752 2	32,5 x 17,6	65	1/3	2,00	●	13,80
83750 8	26,5 x 16,2	65	1/4	1,35	●	12,50
83748 5	17,6 x 16,2	65	1/6	0,80	●	10,00
84300 4	53,0 x 32,5	100	1/1	10,6	○	33,00
84301 1	32,5 x 26,5	100	1/2	4,7	○	19,50
84302 8	53,0 x 16,2	100	2/4	4,3	○	24,00
84303 5	32,5 x 17,6	100	1/3	2,7	○	15,50
84304 2	26,5 x 16,2	100	1/4	1,9	○	14,00
84305 9	17,6 x 16,2	100	1/6	1,0	○	10,50
84306 6	53,0 x 32,5	100	1/1	10,6	●	33,00
84307 3	32,5 x 26,5	100	1/2	4,7	●	19,50
84308 0	53,0 x 16,2	100	2/4	4,3	●	24,00
84309 7	32,5 x 17,6	100	1/3	2,7	●	15,50
84310 3	26,5 x 16,2	100	1/4	1,9	●	14,00
84311 0	17,6 x 16,2	100	1/6	1,0	●	10,50



passende Deckel PC auf Seite 304  
suitable cover PC, see page 304



GN1/6  
83749 65 mm  
84305 100 mm



82029  
GN1/4

**GN-Deckel**  
GN-lid  
tapa GN  
couvrele GN



	GN	€
82001 2	1/1	9,00
82013 5	1/2	5,00
82019 7	1/3	4,00
82029 6	1/4	3,20
82037 1	1/6	2,50
82059 3	1/9	2,20

# FRUITS designed by EsserDesign



83951



83952



83953



83954

## Schale „FRUITS“ bowl cuenco saladier FRUITS

innen weiß  
white inside  
interior blanco  
intérieur blanc



	□ cm	↑ cm	ltr.		€
83951 9	Ø 15	7,5	0,45	außen Erdbeer-Dekor outside strawberry decor exterior motivo de fresa extérieur motif fraise	5,30
83952 6	Ø 15	7,5	0,45	außen Orangen-Dekor outside orange decor exterior motivo de naranja extérieur motif orange	5,30
83953 3	Ø 15	7,5	0,45	außen Zitronen-Dekor outside lemon decor exterior motivo de limón extérieur motif citron	5,30
83954 0	Ø 15	7,5	0,45	außen Kiwi-Dekor outside kiwi decor exterior motivo de kiwi extérieur motif kiwi	5,30



83968  
3,3 ltr.  
ohne Dekor



83969  
3,3 ltr.  
ohne Dekor

## Schale „FRUITS“ bowl cuenco saladier FRUITS

innen weiß  
white inside  
interior blanco  
intérieur blanc



	□ cm	↑ cm	ltr.		€
83968 7	Ø 28	14	3,3	außen rot / outside red exterior rojo / extérieur rouge uni	23,00
83969 4	Ø 28	14	3,3	außen grün / outside green exterior verde / extérieur vert uni	23,00

**HOT  
PRICE**



**Feinkostlöffel, 6er Set**  
delicatessen spoon, 6 pcs. set  
juego de 6 cucharas gourmet  
jeu de 6 cuillères gourmet

**SAN**  
KUNSTSTOFF



	□ cm	→ cm	pcs.		€
88626 1	∅ 6	23	6	○ transparent	8,20

**HOT  
PRICE**



**Feinkostlöffel, 6er Set**  
delicatessen spoon, 6 pcs. set  
juego de 6 cucharas gourmet  
jeu de 6 cuillères gourmet

**SAN**  
KUNSTSTOFF



	□ cm	→ cm	pcs.		€
88627 8	∅ 6	23	6	○	8,20

**HOT  
PRICE**



**Feinkostlöffel, 6er Set**  
delicatessen spoon, 6 pcs. set  
juego de 6 cucharas gourmet  
jeu de 6 cuillères gourmet

**SAN**  
KUNSTSTOFF



	□ cm	→ cm	pcs.		€
88628 5	∅ 6	23	6	●	8,20

**HOT  
PRICE**



**Feinkost- / Olivenlöffel, 6er Set**  
delicatessen / olives spoon, 6 pcs. set  
juego de 6 cucharas para olivas  
jeu de 6 cuillères à olives

**SAN**  
KUNSTSTOFF



geloct  
perforated  
perforadas  
perforées

	□ cm	→ cm	pcs.		€
88598 1	6 x 9	27	6	●	10,00

Dressinglöffel  
dressing spoon  
cuchara de aliño  
cuillère à sauce



**HOT  
PRICE**



	☐ cm	→ cm		€
88636 0	Ø 6	34	○	3,30
88609 4	Ø 6	34	●	3,30

Dressingtopf „CASUAL“  
dressing pot  
salsera alta  
saucière



	☐ cm	↑ cm	litr.		€
83867 3	Ø 12	21,5	1	○	24,00
83868 0	Ø 12	21,5	1	●	24,00

tiefer Schwerpunkt  
erhöhte Standfestigkeit

mit Antirutsch-Füßchen  
non-slip feet  
con pies antideslizantes  
avec pieds anti-dérapants



Salat-Löffel  
salad spoon  
cuchara  
cuillère



	☐ cm	↑ cm		€
84036 2	24 x 7	4		3,70

Salat-Löffel  
salad spoon  
cuchara  
cuillère



	☐ cm	↑ cm		€
84035 5	24 x 7	4,5		2,40

**10 Schilderhalter „FLEX CLIP“**  
**10 sign holders**  
**set de 10 clips**  
**set de 10 porte-étiquettes**



Durch die bewegliche Verbindung der Klemme und Schilderhalterung ein extrem flexibler Cliphalter!

multi angle ticket clip  
 inclinable con pinza  
 inclinable avec pince  
 → cm

	→ cm		€
71472 4	9,5	○ elfenbein / ivory	12,60
71473 1	12,5	○ elfenbein / ivory	13,70
71474 8	9,5	●	12,00
71475 5	12,5	●	13,70

**Zubehör / spare parts / recambios / pièces de rechange**

passende Schilder, 10er Set / fitting signs, 10 pcs. set  
 set de 10 cartelitos / set de 10 étiquettes

	cm	pcs.	€
11879 9	7,7 x 5,2	10	4,90
12879 8	5,0 x 3,0	10	4,60



**10 Beschriftungsclips, inkl. 10 Schilder**  
**10 sign holders, with 10 signs**  
**10 soportes + 10 cartelitos**  
**10 supports + 10 étiquettes**



	cm	pcs.	€
71482 3	6 x 2,7	10	10,50
71483 0	6 x 2,7	10	10,50

**Einzelteile / spare parts / piezas sueltas / pièces détachées**

passende Schilder, 10er Set / fitting signs, 10 pcs. set  
 set de 10 cartelitos / set de 10 étiquettes

	cm	pcs.	€
11879 9	7,7 x 5,2	10	4,90
12879 8	5,0 x 3,0	10	4,60



**Schilderhalter „FLEXIBEL“**  
**sign holder**  
**soporte para cartelito**  
**support pour menu de table**



biegsamer Draht mit zwei Klemmen, extrem flexibel, die Klemmen lassen sich weit öffnen  
 bedable metal coil adds visual interest, two metal clip open  
 metal cromado flexible, 2 pinzas con gran apertura  
 métal chromé, flexible, 2 pinces à grande ouverture

**in 2 Längen  
 erhältlich**



	→ cm		€
71470 0	12	ohne Schilder / without signs sin cartelitos / sans étiquette	3,50
71471 7	23	ohne Schilder / without signs sin cartelitos / sans étiquette	4,20
71480 9	12	inkl. 10 Schilder 11879 / incl. 10 signs 11879 con 10 cartelitos 11879 / avec 10 étiquettes 11879	8,40
71481 6	23	inkl. 10 Schilder 11879 / incl. 10 signs 11879 con 10 cartelitos 11879 / avec 10 étiquettes 11879	9,00

designed by **CULTURE FORM**



84020



84021



Servierlöffel „PROFI“  
serving-spoon  
cuchara  
cuillère



	cm	→ cm		€
84020 1	7 x 6,5	26,5	○	5,40
84021 8	7 x 6,5	26,5	●	5,40



rutschsicher /  
slip-proof

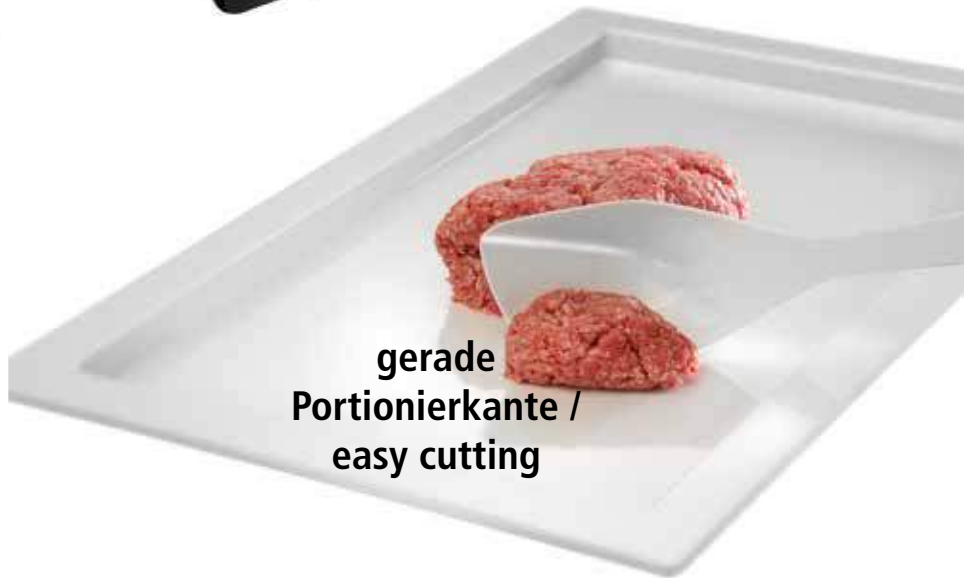

gerade  
Portionierkante /  
easy cutting



einfach abstreifen /  
simply wipe off



Tiefe Ecken? - Kein Problem!  
Deep corners? No problem!

Servierartikel aus Edelstahl . Porzellan . Glas . Holz . Schiefer  
serving items stainless steel . porcelain . glass . wood . slate  
artículos de servicio en inox . porcelana . vidrio . madera . pizarra  
pièces de service en inox . porcelaine . verre . bois . ardoise

# SNACKHOLDER

Originelles Servieren



## Servier-Frittierkorb „SNACKHOLDER“ stainless steel fry baskets cestitas inox para el servicio mesa paniers inox pour le service sur table



Die Mini-Edestahlkörbchen dienen dem portionsweisen Servieren. Zum originellen Servieren von Beilagen geeignet, aber auch zum Frittieren selbst.

The mini frying baskets are used to present individual portions in an original way, but can still be used to fry.

Las cestas de freir ofrecen una presentación original para el servicio de tapas o raciones individuales de patatas, aperitivos, fritos, etc. También se pueden usar para freír.

Les paniers à friture offrent une présentation originale pour servir apéritifs, snacks, tapas et autres rations individuelles. Également aptes pour frire.

	□ cm	↑ cm	Griff cm	€
40600 1	Ø 8	7,5	9,5	8,60
40601 8	Ø 9	8,5	9,0	10,40
40610 0	21,5 x 10,5	4,5	9,5	14,40
40611 7	26 x 13	5,0	9,5	16,80
40620 9	10,0 x 8,5	6,5	9,0	12,00
40621 6	13,0 x 10,5	9,0	13,5	15,40



# SNACKHOLDER

Originelles Servieren



Servierartikel  
serving items

**NEW**



## Servier-Frittierkorb „SNACKHOLDER“ stainless steel fry baskets cestitas inox para el servicio mesa paniers inox pour le service sur table



goldfarben, beschichtet im PVD-Verfahren  
gold colour, made from PVD coated stainless steel  
cestitas de freir de acero inoxidable, doradas mediante PVD  
paniers à friture en acier inox, doré par procédé PVD

	□ cm	↑ cm	Griff cm		€
40602 5	Ø 8	7,5	9,5	● gold colour	9,90
40603 2	Ø 9	8,5	9,0	● gold colour	11,90
40612 4	21,5 x 10,5	4,5	9,5	● gold colour	16,00
40613 1	26 x 13	5	9,5	● gold colour	18,60
40622 3	10 x 8,5	6,5	9,0	● gold colour	14,50
40623 0	13 x 10,5	9	13,5	● gold colour	17,90



EAN = 40 04 133 XXXX X



**NEW**

40616



**Snackholder  
serving cup  
sirve el vaso  
sers le gobelet**



Edelstahl, außen verkupfert  
stainless steel, outside copper coated  
acero inoxidable, el exterior está cubierto de cobre  
acier inoxydable, l'extérieur est cuivré



40617

40618  
gehämmerte Oberfläche  
hammered



	□ cm	↑ cm	ltr.		€
40616 2	Ø 9,5	8,5 / 11,5	0,45	● copper	5,60
40617 9	Ø 8,5	8,5	0,35	● copper	4,20
40618 6	Ø 8,5	8,5	0,35	● gehämmerte Oberfläche hammered	4,60

40605



**Snackholder  
serving cup  
sirve el vaso  
sers le gobelet**



Edelstahl  
stainless steel  
acero inoxidable  
acier inoxydable



40606

40607  
gehämmerte Oberfläche  
hammered



	□ cm	↑ cm	ltr.		€
40605 6	Ø 9,5	8,5 / 11,5	0,45		4,90
40606 3	Ø 8,5	8,5	0,35		3,60
40607 0	Ø 8,5	8,5	0,35	gehämmerte Oberfläche hammered	4,00



40616



40617



40618



40605



40606



40607



**Servier- / Saucen-Eimer „SNACKHOLDER“**  
**mini stainless steel bucket**  
**cubo inox en formato mini**  
**seau mini inox**



	cm	↑ cm	ltr.	pcs.	€
40630 8	Ø 7	6,5	0,15	4	13,40
40631 5	Ø 9	8,5	0,33	1	4,40



40630  
4er Set

40631  
1 Stk. / 1 pc.

40630  
4er Set



**Mini-Milchkanne „SNACKHOLDER“**  
**mini milk can**  
**lechera en formato mini**  
**pot à lait mini**



	cm	↑ cm	ltr.	pcs.	€
40640 7	Ø 4,5	5	0,08	4	16,00
40641 4	Ø 7,5	9,5	0,45	1	9,90



40640  
4er Set

40641  
1 Stk. / 1 pc.

40640  
4er Set



**Mini-Seiher „SNACKHOLDER“**  
**mini colander**  
**colador en formato mini**  
**passoire mini**



	cm	↑ cm		€
40650 6	Ø 10	6		2,70
40651 3	Ø 13	6		3,90

40650

40651



**Mini-Servierpfanne „SNACKHOLDER“**  
**mini pan**  
**sartén en formato mini**  
**poêle à frire mini**



	cm	↑ cm	ltr.	€
40660 5	14,5 x 9,5	4,5 / 6,5	0,5	10,50



Wachspapier „SNACKHOLDER“, 500 Stck.  
greaseproof paper squares, 500 pcs.  
papel alimenticio para cucurucho, 500 pz.  
papier alimentaire pour cornet, 500 pc.

	cm	pcs.		€
40670 4	42 x 25	500	Motiv: Zeitung	57,00
40671 1	42 x 25	500	blank	31,00
40672 8	42 x 25	500	Motiv: rote Karos	57,00
40673 5	42 x 25	500	Motiv: blaue Karos	57,00

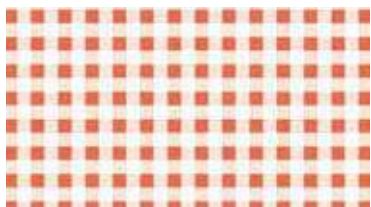

40672



40673



00536



6 Löffel

Gourmetlöffel, 6er Set  
gourmet spoons, 6 pcs. set  
cucharas gourmet, el pack de 6  
cuillères gourmet, le pack de 6



hochglanzpoliert, zur Präsentation von Vorspeisen  
mirror polished finish, perfect to present appetiser  
acabado brillante, perfecto para presentar aperitivos  
poli brillante, parfait pour les apéritifs et entrées

	cm	pcs.	€
00682 9	11 x 4	6	12,00



00691 Edelstahl-Gold-Look



00677 Edelstahl poliert



00692 Edelstahl-Kupfer-Look



Gourmet-Löffel „CLASSIC“  
party spoon  
cuchara  
cuillère



	→ cm		€
00677 5	13,5	Edelstahl-Look / stainless steel look	2,40
00691 1	12	Gold-Look / gold look	5,00
00692 8	12	Kupfer-Look / copper look	5,00

NEW



**Tablett „TREND“  
baking sheet  
placa pastelera  
plaque à pâtisserie**



Ein Backblech wird zum Servier-Objekt/Serviertablett.

A baking sheet which becomes a serving tray.

Una bandeja pastelera que se convierte en una bandeja de servir.

Une plaque à pâtisserie qui devient un plateau de service.

	☐ cm	↑ cm		€
13380 8	32,0 x 21,5	2		8,90

NEW



**Quetschflasche „MINI“, 4er Set  
squeeze bottle, 4 pcs.  
bote dosificador flexible, 4 pz.  
bouteille verseuse souple, 4 pc.**



mit Schraubdeckel und Verschlusskappe, ideal zum Servieren von Dressing und Saucen

with tight-screw and cap, ideal for serving dressing and sauces

tapa de rosca, con tapón, ideal para servir aliño y salsas

bouchon à vis de étanche, avec bouchon, idéal pour servir de vinaigrette et sauces

	☐ cm	↑ cm	ltr.	pcs.	€
93225 8	Ø 3,0	8,5	0,03	4	4,00
93226 5	Ø 3,5	9,5	0,05	4	4,40

93225

93226

**Anwendungsbeispiel:  
Food Styling**



**Anwendungsbeispiel:  
Dressingflasche**



**NEW**

**Servierbrett „GENUSSPALETTE“**  
 serving board  
 tabla de servir  
 planche de service



00880  
20 x 12 cm

Genusspalette im Kleinformat, Birke  
 mini serving palett, birch  
 tabla de servir, formato pequeño, abedul  
 planche de service, petit format, bouleau

	□ cm	↑ cm	€
00880 9	20 x 12	3	8,60
00881 6	30 x 20	3	10,20
00882 3	40 x 15	3	13,00



00881  
30 x 20 cm



00882  
40 x 15 cm

**NEW**

**Servierbrett "AKAZIE-SCHIEFER"**  
 serving board  
 tabla de servir  
 planche de service



00867  
30,5 x 13,0

Raffiniertes, rustikales Servierbrett aus Akazienholz, ausgestattet mit einem Naturschieferstreifen zur Kennzeichnung.

wood with slate, markable  
 madera con pizarra, se puede marcar  
 bois avec ardoise, on peut mettre une inscription

	□ cm	↑ cm	€
00867 0	30,5 x 13,0	1,5	14,00
00868 7	36,5 x 15,0	1,5	18,00
00869 4	42,0 x 18,0	1,5	21,00



00868  
36,5 x 15,0



00869  
42,0 x 18,0



00870

**Servier-Brett „OLIVE“**  
**servicing board**  
**Tabla de servir en madera de olivo**  
**Planche de service en bois d'olivier**



Servierbrett im Naturschnitt, aus Olivenholz. Jedes Brett wird handgefertigt und lackiert mit 19 mm Aufhäng Bohrung. Alle Produkte unterscheiden sich naturbedingt in Form, Maserung und Größe!

Olive Wood is known for its versatility and striking appearance with each piece having its own unique features.

El olivo es conocido por su versatilidad y aspecto espectacular y único en cada pieza. Por su fabricación a mano de forma artesanal, todas las piezas varían en tamaño, forma y acabado, lo que hace de cada una un ejemplar único.

Le bois d'olivier est reconnu pour sa versatilité et son esthétique spectaculaire. De par leur fabrication artisanale à la main, toutes les pièces varient quant à leur taille, forme et finition, de telle sorte que chacune est un exemplaire unique.



00874



00876

	□ cm	↑ cm		€
00870 0	25,0 x 17,0	1,5		28,00
00871 7	30,0 x 20,5	2,0		46,00
00872 4	35,0 x 24,0	2,0		56,00
00873 1	40,0 x 15,0	1,5	Griff / handle 11 cm	49,00
00874 8	44,0 x 20,0	2,0	Griff / handle 12 cm	64,00
00875 5	19,0 x 12,5	1,5	Griff / handle 6 cm	20,00
00876 2	25,0 x 16,0	1,5	Griff / handle 8 cm	30,00
00877 9	31,0 x 20,0	1,5	Griff / handle 9 cm	46,00

designed by **CULTURE FORM**



Ø 50 cm

**Buffet-Brett „XXL“**  
**board**  
**tabla para el bufé**  
**planche à découper buffet**



Buchenholz geölt, mit Antirutsch-Füßchen  
beech wood oiled, with non-slip feet  
madera de haya tratada con aceite, pies antideslizantes  
bois hêtre huilé, pieds antiglisse

	□ cm	↑ cm	€
00866 3	Ø 50	4,5	74,00

**passende Rolltophaube / suitable rolltop cover / campana abatible / cloche basculante**

18380 3	Ø 50	26	54,00
---------	------	----	-------

designed by **CULTURE FORM**



11016

00865

**Buffet-Brett**  
**board**  
**tabla para el bufé**  
**planche à découper buffet**



Buchenholz, mit Antirutsch-Füßchen  
beech wood, with non-slip feet  
haya, pies antideslizantes  
hêtre, pieds antidérapants

	□ cm	↑ cm	€
00865 6	58 x 38	2,5	42,00

**passende Rolltophaube / suitable rolltop cover / campana abatible / cloche basculante**

	□ cm	↑ cm	Seite/page	€
11016 8	53,0 x 32,5	19	449	62,00
11008 3	53,0 x 32,5	19	449	59,90
11010 6	53,0 x 32,5	19	449	59,90

Griffmulde

designed by **CULTURE FORM**



**Buffet-Brett „FISCH“**  
board  
tabla para el bufé  
planche à découper buffet



Buchenholz, mit Antirutsch-Füßchen  
beech wood, with non-slip feet  
haya, pies antideslizantes  
hêtre, pieds antidérapants

	cm	↑ cm	€
00860 1	76 x 23	2,5	37,00

designed by **CULTURE FORM**



**Buffet-Brett „RIND“**  
board  
tabla para el bufé  
planche à découper buffet



Buchenholz, mit Antirutsch-Füßchen  
beech wood, with non-slip feet  
haya, pies antideslizantes  
hêtre, pieds antidérapants

	cm	↑ cm	€
00861 8	62 x 34	2,5	39,50

designed by **CULTURE FORM**



**Buffet-Brett „SCHWEIN“**  
board  
tabla para el bufé  
planche à découper buffet



Buchenholz, mit Antirutsch-Füßchen  
beech wood, with anti-slip feet  
haya, pies antideslizantes  
hêtre, pieds antidérapants

	cm	↑ cm	€
00862 5	66 x 30	2,5	39,50

designed by **CULTURE FORM**



18388



**Buffet-Brett „TRAUBE“**  
board  
tabla para el bufé  
planche à découper buffet

Buchenholz, Antirutsch-Füßchen  
beech wood, non-slip feet  
haya, pies antideslizantes  
hêtre, pieds antidérapants

	cm	↑ cm	€
00863 2	43,5 X 38	2,5	34,20

**Rolltophaube / rolltop cover / campana abatible / cloche basculante**

18388 9	Ø 38	20	19,40
---------	------	----	-------



# ENAMELWARE

Die Neu-Interpretation von Altbewährtem: Die Becher aus emailliertem Stahl eignen sich für alle Arten von Heißgetränken aber auch als trendige Behältnisse für unterschiedlichste Speisen. Ob Frittiertes, frische Gemüsesticks oder Desserts - die Becher vermitteln einfach eine gewisse **Coolness und Trend!**



**NEW**



40637  
Ø 10 cm

**Henkelbecher „ENAMELWARE“**  
beaker  
vaso coctelero  
bol mélangeur



	□ cm	↑ cm	ltr.		€
40636 0	Ø 7	5	0,10	● white / blue	4,10
40632 2	Ø 9	8	0,35	● white / blue	3,90
40633 9	Ø 9	8	0,35	● red / black	6,90
40634 6	Ø 9	8	0,35	● green / black	6,90
40635 3	Ø 9	8	0,35	● blue / black	6,90
40637 7	Ø 10	9	0,50	● white / blue	4,40



40636  
Ø 7 cm



40632  
Ø 9 cm



40633  
Ø 9 cm



40634  
Ø 9 cm



40635  
Ø 9 cm

**NEW**



**Schale „ENAMELWARE“**  
bowl  
bol  
bol



emailliertes Stahlblech, blauer Rand  
enamelled steel, blue edge  
hierro esmaltado, borde azul  
acier émaillé, bord bleu

	□ cm	↑ cm	ltr.	€
40638 4	Ø 13	6	0,50	● white / blue 4,60



3 Größen / 3 sizes



40664 - 40666  
Ø 20 - 24 - 26 cm

Teller „ENAMELWARE“  
tray  
bandeja  
plateau



	□ cm	↑ cm		€
40664 3	Ø 20	2,0	●	flacher Teller 4,40
40665 0	Ø 24	2,0	●	flacher Teller 6,40
40666 7	Ø 26	2,0	●	flacher Teller 6,90



3 Größen / 3 sizes



40661 - 40663  
Ø 18 - 22 - 24 cm

Teller „ENAMELWARE“  
tray  
bandeja  
plateau



	□ cm	↑ cm		€
40661 2	Ø 18	3,5	●	tiefer Teller 6,90
40662 9	Ø 22	3,5	●	tiefer Teller 7,40
40663 6	Ø 24	3,5	●	tiefer Teller 7,90



**NEW**

2 Größen / 2 sizes



40667

Schale „ENAMELWARE“  
bowl  
bol  
bol



	cm	↑ cm	ltr.		€
40667 4	16 x 12	3,5	0,20	●	5,40
40668 1	18 x 13,5	4,0	0,35	●	6,20



**NEW**



Schale „ENAMELWARE“  
bowl  
bol  
bol



	cm	↑ cm	ltr.		€
40669 8	28 x 23	4,5	1,9	●	14,00

# NATURSCHIEFER



rutschfeste,  
möbelschonende  
Füßchen

00990  
GN1/1



00991  
GN1/2

00992  
GN1/3



00993  
GN1/4

## Naturschieferplatten GN natural slate tray GN bandeja de pizarra natural GN plat ardoise naturelle GN



hervorragende Kältespeicherung durch Naturschiefer, um die typische Struktur des Materials hervorzuheben, sind die Kanten der Platten gebrochen und nicht gesägt

excellent coldness store, food safe, waterproof

excelente conservador del frio, para reforzar la estética natural, los bordes ofrecen un canto irregular

excellent maintien du froid, les bords sont volontainement cassés pour renforcer l'esthétique naturelle

	cm	mm	GN	€
00990 5	53,0 x 32,5	5 - 8	1/1	15,00
00991 2	32,5 x 26,5	4 - 7	1/2	8,40
00992 9	32,5 x 17,6	4 - 7	1/3	5,00
00993 6	26,5 x 16,2	4 - 7	1/4	4,60
00973 8	53,0 x 16,2	4 - 7	2/4	6,00



## Naturschieferplatte rechteckig natural slate tray rectangular bandeja de pizarra natural rectangular plat ardoise naturelle rectangulaire



	cm	mm	€
00996 7	45 x 30	4 - 7	12,00



## Naturschieferplatte quadratisch natural slate tray square bandeja de pizarra natural cuadrada plat ardoise naturelle carré



	cm	mm	€
00994 3	25 x 25	4 - 7	6,00
00995 0	30 x 30	4 - 7	9,00



00941



00945



00942



rutschfeste,  
möbelschonende  
Füßchen

**Naturschieferplatte**  
natural slate  
bandeja de pizarra natural  
plateau ardoise naturelle



	cm	mm	€
00941 7	24,0 x 15,0	5	3,90
00945 5	47,0 x 10,0	5	6,00
00942 4	26,5 x 20,5	5	6,00
00988 2	30,0 x 12,0	5	4,00



00988

83433 Melamintablett GN2/4  
00945 Schieferplatte

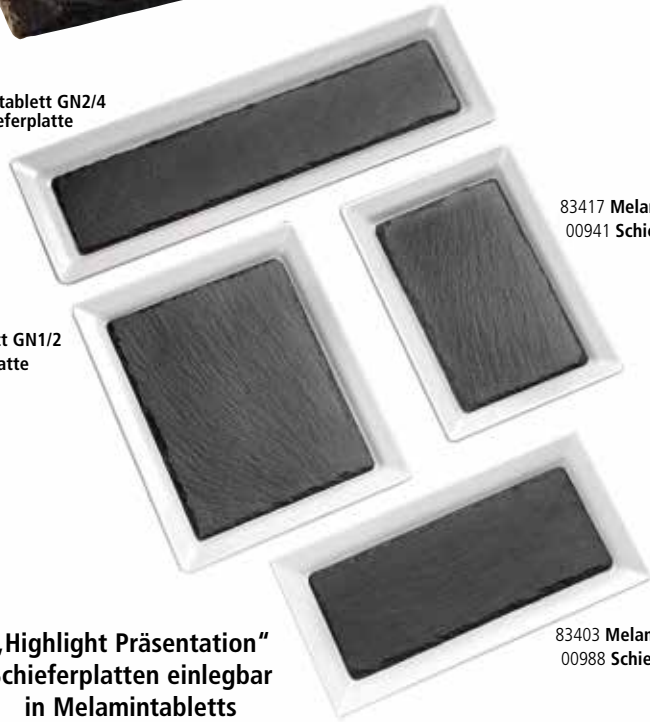

83417 Melamintablett  
00941 Schieferplatte

83480 Melamintablett GN1/2  
00942 Schieferplatte

83403 Melamintablett  
00988 Schieferplatte

**„Highlight Präsentation“**  
Schieferplatten einlegbar  
in Melamintabletts

**NEW**



4 cm Nutzhöhe / distance 4 cm

**GN1/1 Naturschieferplatte „HOCHSTAPLER“**  
GN1/1 natural slate tray  
GN1/1 bandeja de pizarra natural  
GN1/1 plat ardoise naturelle

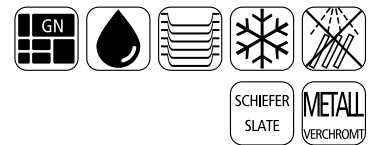

	cm	cm	mm		€
00966 0	53,0 x 32,5	6	7-9	Griffe verchromt / chrome plate handles	32,00

**NEW**



**Naturschieferplatte "STARTER"**  
**natural slate tray**  
**bandeja de pizarra natural**  
**plat ardoise naturelle carré**



rutschfeste, möbelschonende Füßchen  
 non-slip feet  
 pies antideslizantes  
 pieds antidérapants

	cm	mm	€
00937 0	20 x 10	4 - 7	2,90
00938 7	30 x 10	4 - 7	3,40
00939 4	30 x 15	4 - 7	4,00

**NEW**

**2er Set / 2 pcs. set**



**Naturschieferplatte, 2er Set**  
**natural slate tray, 2 pcs.**  
**bandeja de pizarra natural, 2 pz.**  
**plat ardoise naturelle, 2 pc.**



rutschfeste, möbelschonende Füßchen, mit Safrinne  
 non-slip feet, with juice groove  
 pies antideslizantes  
 pieds antidérapants, avec cannelure

	cm	mm	pcs.	€
00935 6	Ø 23	4 - 7	2	Griff: 8 cm / handle: 8 cm asa: 8 cm / anse: 8 cm 12,90
00936 3	26 x 20	4 - 7	2	Griff: 8 cm / handle: 8 cm asa: 8 cm / anse: 8 cm 12,90



**Naturschieferplatten rund**  
**natural slate tray round**  
**bandeja de pizarra natural redonda**  
**plat ardoise naturelle rond**



	cm	mm	€
00968 4	Ø 22	4 - 7	4,90
00969 1	Ø 28	4 - 7	7,00
00998 1	Ø 33	4 - 7	8,00
00999 8	Ø 38	4 - 7	12,00

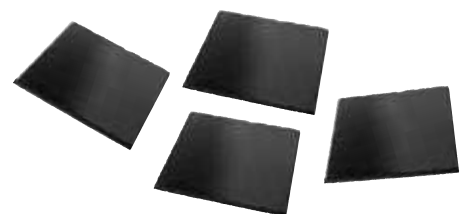

**Naturschieferplatten, 4er Set**  
**natural slate tray, 4 pcs. set**  
**set de 4 piezas, pizarra natural**  
**set de 4 pièces, ardoise naturelle**



	cm	mm	€
00997 4	10 x 10	4 - 7	8,00

**NEW**

Ø 20 cm

Ø 25 cm

Ø 30 cm



**3-stufige Etagère**  
**3-tier tray**  
**bandeja con tres alturas**  
**étagère carré 3 hauteurs**



rutschfeste, möbelschonende Füßchen, Naturschiefer, Akazienholz  
 non-slip feet, natural slate tray, wood akazie  
 pies antideslizantes, bandeja de pizarra natural, madera  
 pieds antidérapants, plateau ardoise naturelle, bois

	□ cm	↑ cm	✱ mm	€
00960 8	Ø 30 / 25 / 20	34	4 - 7	26,00



**2-stufige Etagère**  
**2 tier tray**  
**bandeja dos alturas**  
**plat carré 2 hauteurs**



rutschfeste, möbelschonende Füßchen, Naturschiefer  
 non-slip feet, natural slate tray  
 pies antideslizantes, bandeja de pizarra natural  
 pieds antidérapants, plateau ardoise naturelle

	□ cm	↑ cm	✱ mm	€
00989 9	Ø 25 / 20	24	4 - 7	13,20



**Buffet-Set, 3-teilig**  
**rolltop-set, 3 pcs.**  
**set rolltop, 3 piezas**  
**set rolltop, 3 pièces**



1 Edelstahltablett Ø 38 cm + 1 Naturschieferplatte Ø 33 cm + 1 Rolltop-Haube Ø 38 cm  
 1 stainless tray Ø 38 cm + 1 natural slate tray Ø 33 cm + 1 rolltop cover Ø 38 cm  
 1 bandeja de acero inoxidable Ø 38 cm + 1 bandeja de pizarra natural Ø 33 cm + 1 tapa abatible Ø 38 cm  
 1 plat inox 38 cm + 1 plat ardoise naturelle 33 cm + 1 cloche 38 cm

	□ cm	↑ cm	€
01000 0	Ø 38	24	44,00



**Tortenplatte / Servierplatte drehbar**  
**cake stand**  
**soporte para pastel**  
**présentoir à gâteaux**



	□ cm	↑ cm	✱ mm	€
00975 2	Ø 32	2,5	4-7	16,00

2 Absätze  
Ø 6 cm



40541  
Salzmühle



40540  
Pfeffermühle

**Naturschieferplatte / Untersetzer**  
**natural slate tray**  
**bandeja de pizarra natural**  
**plateau ardoise naturelle**



mit 2 Absätzen Ø 6 cm  
with 2 holes Ø 6 cm  
con 2 agujeros Ø 6 cm  
avec 2 trous Ø 6 cm

	cm	mm	€
00971 4	15 x 8	4 - 7	3,00



82316  
Weck-Glas  
220 ml



**Naturschieferplatte, 2-teilig**  
**natural slate tray, 2 pcs. set**  
**bandeja de pizarra natural y campana**  
**plateau ardoise naturelle et cloche en verre**



mit Glashaube  
with glass cover  
con tapa de cristal  
avec cloche en verre

	cm	cm	mm	€
00984 4	Ø 10,5	8	4 - 7	8,00



**Naturschieferplatte**  
**natural slate tray**  
**bandeja pizarra natural**  
**plat ardoise naturelle**



mit Absatz Ø 6 cm  
with hole Ø 6 cm  
con agujero Ø 6 cm  
avec trou Ø 6,0 cm

	cm	mm	€
00986 8	25 x 12	4 - 7	3,90



**Weck-Gläser**  
**82310, 82312 und**  
**82314**

**Naturschieferplatte**  
**natural slate tray**  
**bandeja pizarra natural**  
**plat ardoise naturelle**



mit 3 Absätzen, Ø 6 cm  
with 3 holes, Ø 6 cm  
con 3 agujeros, Ø 6 cm  
avec 3 trous, Ø 6 cm

	cm	mm	€
00987 5	28 x 10	4 - 7	5,40



# GASTRONORM SPIEGELPLATTEN

GN MIRROR GLASS PLATTER / ESPEJOS GN / MIROIRS GN

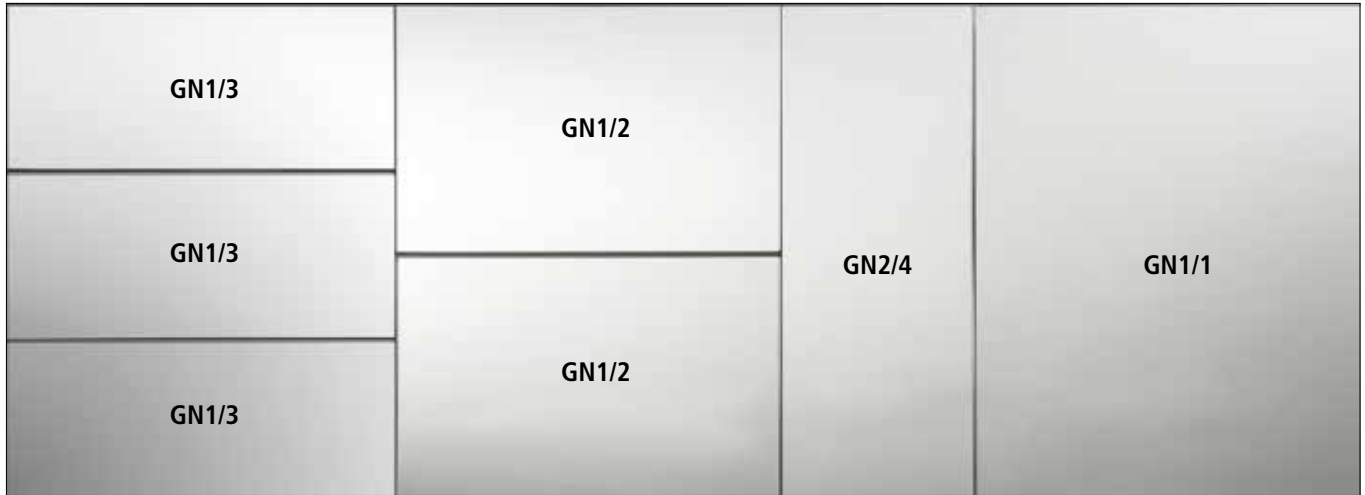

Servierartikel  
serving items



## Glasplatte „MIRROR SILVER“ glass platter espejos sobre vidrio plateau miroir en verre



silber spiegelndes Glas, mit Antirutsch-Füßchen  
silver mirror glas, non-slip feet  
espejo plateado, pies antideslizantes  
plateau miroir argenté, pieds antiglisse

	□ cm	↑ cm	GN	€
00961	53 x 32,5	3	1/1	23,00
00962	32,5 x 26,5	3	1/2	12,00
00963	32,5 x 17,6	3	1/3	10,50
00964	53 x 16,2	3	2/4	11,50



## Glasplatte „MIRROR BLACK“ glass platter bandeja espejo negro en vidrio plateau miroir noir en verre



schwarz spiegelndes Glas, mit Antirutsch-Füßchen  
black mirror glas, non-slip feet  
bandeja espejo negro, pies antideslizantes  
plateau miroir noir en verre, pieds antiglisse

	□ cm	↑ cm	GN	€
00929	53 x 32,5	3	1/1	24,00
00930	32,5 x 26,5	3	1/2	12,00
00931	32,5 x 17,6	3	1/3	10,50
00932	53 x 16,2	3	2/4	11,50



Welle / Wave / ola / vague

00985	1	53 x 32,5	3	1/1	26,50
-------	---	-----------	---	-----	-------

rund / round / redondo / rond

00983	7	Ø 50	3		36,50
-------	---	------	---	--	-------





# ORIGINAL WECK



**Weck-Flaschen, 6er Set**  
**Weck-bottles**  
**Weck-botellas**  
**Weck-bouteilles**



6 Flaschen + 6 Deckel, ideal zum Servieren von Saft, Smoothie, Dressing und Saucen  
 6 bottles + 6 covers, ideal for serving juice, smoothie, dressing and sauces  
 6 botellas + 6 tapas, ideal para servir zumo, licuado, aliño y salsas  
 6 bouteilles + 6 couvercles, idéal pour servir de jus, smoothie, vinaigrette et sauces



	 cm	 cm	ltr.	pcs.	€
82307 5	Ø 6	14,5	0,25	6	10,90



**Weck-Flaschen, 6er Set**  
**Weck-bottles**  
**Weck-botellas**  
**Weck-bouteilles**



6 Flaschen + 6 Deckel, ideal zum Servieren von Saft, Smoothie, Dressing und Saucen  
 6 bottles + 6 covers, ideal for serving juice, smoothie, dressing and sauces  
 6 botellas + 6 tapas, ideal para servir zumo, licuado, aliño y salsas  
 6 bouteilles + 6 couvercles, idéal pour servir de jus, smoothie, vinaigrette et sauces



	 cm	 cm	ltr.	pcs.	€
82308 2	Ø 6	19	0,5	6	12,10



**Weck-Flaschen, 6er Set**  
**Weck-bottles**  
**Weck-botellas**  
**Weck-bouteilles**



6 Flaschen + 6 Deckel, ideal zum Servieren von Saft, Smoothie, Dressing und Saucen  
 6 bottles + 6 covers, ideal for serving juice, smoothie, dressing and sauces  
 6 botellas + 6 tapas, ideal para servir zumo, licuado, aliño y salsas  
 6 bouteilles + 6 couvercles, idéal pour servir de jus, smoothie, vinaigrette et sauces

	 cm	 cm	ltr.	pcs.	€
82309 9	Ø 6	25,5	1,0	6	14,20



82310  
80 ml

**Weck-Gläser mit Deckel, 12er Set**  
**Weck-glasses with lid**  
**Weck tarros de vidrio con tapa**  
**Weck verrines avec couvercle**



12 Gläser + 12 Deckel  
 12 glasses + 12 covers  
 12 vasos + 12 tapas  
 12 verrines + 12 couvercles



82312  
140 ml



	□ cm	↑ cm	ltr.	pcs.	€
82310 5	Ø 6	5,5	0,08	12	18,00
82312 9	Ø 6	7,0	0,14	12	19,70
82314 3	Ø 6	8,0	0,16	12	19,70
82345 7	Ø 9	6,0	0,20	12	19,70
82316 7	Ø 7	8,0	0,22	12	19,70



82314  
160 ml



82316  
220 ml



82345  
200 ml



passende Gläser:  
82310, 82312  
oder 82314

**Gestell - 12 x Ø 6 cm**  
33246  
ohne Gläser  
without glasses

**Serviergestell „WECK“**  
**serving stand**  
**expositor**  
**présentoir**



	□ cm	↑ cm		€
33247 8	Ø 22	33	6 x Ø 6 cm	54,00
33246 1	Ø 22	59	12 x Ø 6 cm	85,00



passende Gläser:  
82310, 82312  
oder 82314

**Gestell - 6 x Ø 6 cm**  
33247  
ohne Gläser  
without glasses

**Weck-Gläser mit Deckel, 3er Set**  
**Weck-glasses with lid, 3 pcs.**  
**Weck tarros de vidrio con tapa**  
**Weck verrines avec couvercle**



3 Gläser + 3 Deckel  
 3 glasses + 3 covers  
 3 vasos + 3 tapas  
 3 verrines + 3 couvercles

	cm	cm	ltr.	pcs.	€
82346 4	Ø 11	7,5	0,37	3	6,10

**Weck-Gläser mit Deckel, 2er Set**  
**Weck-glasses with lid, 2 pcs.**  
**Weck tarros de vidrio con tapa**  
**Weck verrines avec couvercle**



2 Gläser + 2 Deckel  
 2 glasses + 2 covers  
 2 vasos + 2 tapas  
 2 verrines + 2 couvercles

	cm	cm	ltr.	pcs.	€
82347 1	Ø 11	11	0,58	2	5,40

**Weck-Frischhaltedeckel, 5er Set**  
**airtight cover, 5 pcs.**  
**tapa hermética, 5 pz.**  
**couvercle hermétique, 5 pc.**



für Rundrandgläser Ø 6 cm, 5er Set  
 for Ø 6 cm glasses, 5 pcs. set  
 para vasos Ø 6 cm, 5 pc.  
 pour verrines Ø 6 cm, set de 5

	cm	pcs.	matches	€
82338 9	Ø 7	5	for all glasses Ø 6,5 cm 82310, 82312, 82314, 82307, 82308, 82309, 82370, 82371	2,30

**Zubehör / spare parts / recambios / pièces de rechange**

10er Set Gummidichtringe, für Deckel der Weck-Gläser, im Beutel verpackt / 10 pcs. rubber washer for covers of Weck-glasses / 10 juntas de goma para las tapas de los tarritos Weck / jeu de 10 joints caoutchouc pour la fermeture des verrines Weck



		€
82318 1	for all glasses Ø 6 cm	1,10
82394 5	matches 82345	1,20
82395 2	matches 82346, 82347	1,30

8er Set Deckel-Klammer für 4 Weck-Gläser, im Beutel verpackt / 8 pcs. cover clamps for 4 Weck-glasses / 8 abrazaderas para 4 vasitos Weck / 8 agrafes pour 4 verrines Weck

		€
82319 8		2,30

**Glas mit luftdichtem Klappdeckel**  
**glass with airtight cover**  
**cristal, cierre hermético**  
**verre, fermeture hermétique**



2 ltr.

	cm	cm	ltr.	€
82328 0	12 x 12	22	2	6,20



**Weck-Gläser  
82310, 82312 und  
82314**

**Naturschieferplatte  
natural slate tray  
bandeja pizarra natural  
plat ardoise naturelle**

mit 3 Absätzen, Ø 6 cm  
with 3 holes, Ø 6 cm  
con 3 agujeros, Ø 6 cm  
avec 3 trous, Ø 6 cm



	cm	mm	€
00987 5	28 x 10	4 - 7	5,40



**Naturschieferplatte  
natural slate tray  
bandeja pizarra natural  
plat ardoise naturelle**

mit Absatz Ø 6 cm  
with hole Ø 6 cm  
con agujero Ø 6 cm  
avec trou Ø 6,0 cm



	cm	mm	€
00986 8	25 x 12	4 - 7	3,90



82316  
Weck-Glas  
220 ml

**2 Absätze  
Ø 6 cm**

**Naturschieferplatte / Untersetzer  
natural slate tray  
bandeja de pizarra natural  
plateau ardoise naturelle**

mit 2 Absätzen Ø 6 cm  
with 2 holes Ø 6 cm  
con 2 agujeros Ø 6 cm  
avec 2 trous Ø 6 cm



	cm	mm	€
00971 4	15 x 8	4 - 7	3,00



**passend für Gestell  
33246 + 33247**

**Gourmet-Gläser, 12er Set  
gourmet glasses, 12 pcs.  
pack de 12 tarros Gourmet  
pack de 12 verres Gourmet**



	cm	cm	ltr.	pcs.	€
82370 9	Ø 6	5,5	0,08	12	11,00
82371 6	Ø 6	8,0	0,16	12	11,70
82359 4	Ø 5	3,5	0,035	12	8,20



82359

# PROFI LINE

mit glattem Rand  
11100, 12100



mit Dekor-Rand  
11000, 12000



11110

**Edelstahl-Tablett „PROFI LINE“**  
tray  
bandeja  
plat empilable système catering



hochglanzpoliert  
mirror polished finish  
borde pulido efecto espejo  
effet miroir

	cm	cm	GN		€
11100 4	53,0 x 32,5	1,5	1/1	mit glattem Rand / without decor-edge sin borde decorado / bords lisses	27,00
12100 3	32,5 x 26,5	1,5	1/2	mit glattem Rand / without decor-edge sin borde decorado / bords lisses	16,00
11000 7	53,0 x 32,5	1,5	1/1	mit Dekor-Rand / with decor-edge con borde decorado / bords avec relief	27,00
12000 6	32,5 x 26,5	1,5	1/2	mit Dekor-Rand / with decor-edge con borde decorado / bords avec relief	17,50
11110 3	53,0 x 32,5	1,0	1/1	glatter schmaler Rand / smooth narrow edge borde estrecho liso / bord étroit lisse	16,00



GN1/1 und  
GN1/2

**Edelstahl-Tablett „PROFI LINE“**  
pan  
cubeta  
bac GN



Dekorrand hochglanzpoliert, mit Stapelnocke  
decor edge mirror polished finish  
cubeta de acero inoxidable  
bac GN, bord brillant avec relief, désempilage facile

	cm	cm	GN	ltr.	€
11020 5	53 x 32,5	2,0	1/1	1,7	30,90
11040 3	53 x 32,5	4,0	1/1	3,4	33,80
11065 6	53 x 32,5	6,5	1/1	7,0	37,40
12040 2	32,5 x 26,5	4,0	1/2	2,0	20,40
12065 5	32,5 x 26,5	6,5	1/2	3,3	23,30

**Fleisch- und Gemüseplatte „PROFI LINE“**  
tray  
fuente de servicio  
plat de service



Dekorrand hochglanzpoliert  
decor edge mirror polished finish  
borde decorado pulido efecto espejo  
contour relief avec effet miroir

	cm	cm		€
11032 8	Ø 32	2,6	rund / round / redondo / rond	18,20
11038 0	Ø 38	2,6	rund / round / redondo / rond	27,20
11048 9	Ø 48	2,6	rund / round / redondo / rond	34,60
11023 6	50 x 36	2,6	oval / oval / ovalado / ovale	34,60
11024 3	60 x 41	2,6	oval / oval / ovalado / ovale	47,20
11025 0	70 x 46	2,6	oval / oval / ovalado / ovale	65,40





**System-Tablett „PROFI LINE“**  
 tray  
 bandeja  
 plat empilable système catering



Dekorrand hochglanzpoliert, massive Griffe verchromt, inkl. fest verschraubten Distanzstücken, Nutzhöhe 4 cm  
 decor edge mirror polished finish, chrome plated handles, incl. mounted 4 cm distance pillars  
 borde pulido decorado, asas cromadas, incluye distanciadores a 4 cm  
 bords polis avec reliefs, poignées chromées, distance approx. 4 cm

	cm	GN	€
11300 8	53 x 32,5	1/1	39,50

Distanzstücke können per Hand aufgeschraubt werden und erhöhen die Nutzhöhe auf 8 cm.  
 Distance pieces can be bolted by hand.

**Einzelteile / spare parts / piezas sueltas / pièces détachées**

Distanzstück-Set / distance piece set / set de distanciadores / kit réhausseur			
11310 7			21,00



**System-Tablett „PROFI LINE“**  
 tray  
 bandeja  
 plat empilable système catering



Rand hochglanzpoliert, massive Bügelgriffe vergoldet, inkl. fest verschraubten Distanzstücken, Nutzhöhe 4 cm  
 mirror polished finish edge, gold plated handles, stackable approx. 4 cm  
 borde con acabado pulido, asas doradas, apilables aproximadamente 4 cm  
 contour effet miroir, poignées dorées, empilables distance 4 cm environ

	cm	GN	€
11290 2	53 x 32,5	1/1	33,00

Distanzstücke können per Hand aufgeschraubt werden und erhöhen die Nutzhöhe auf 8 cm.  
 Distance pieces can be bolted by hand.

**Einzelteile / spare parts / piezas sueltas / pièces détachées**

8 cm Distanzstück-Set (4 Stück), vergoldet / 8 cm distance pillars (4 pcs.), gold plated distanciadores a 8 cm (4 piezas) dorado / kit réhausseur (4 pièces) distance totale 8 cm			
11252 0			19,30

**NEW**



**GN1/1 Naturschieferplatte „HOCHSTAPLER“**  
 GN1/1 natural slate tray  
 GN1/1 bandeja de pizarra natural  
 GN1/1 plat ardoise naturelle

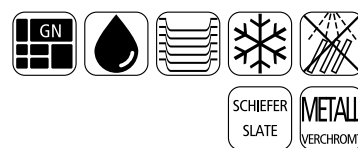

	cm	↑ cm	✱ mm		€
00966 0	53,0 x 32,5	6	7-9	Griffe verchromt / chrome plate handles	32,00



4 cm Nutzhöhe / distance 4 cm

11302  
GN1/1, 2-tlg. Set Tablett + Haube



System-Haube für stapelbare Tablettts wie Nr. 11300, 11290 oder 11295

**Buffet-Set „HOCHSTAPLER“**  
buffet set  
set de bufé  
kit catering plateau + cloche



2-teilig: Tablett 11300 + Haube 11305, Tablett fixiert sich auf der Haube - kein Rutschen möglich

2 pcs. set: tray 11300 + cover 11305, tray fixes itself on the cover and can not slip off

2 piezas: bandeja 11300+ tapa 11305 la bandeja se fija a la tapa para que no se deslice

2 pièces: plateau réf. 11300 + cloche spéciale empilement stable

	cm	cm	GN	€
11302 2	53 x 32,5	10,5	1/1	68,00

11195  
2-tlg. Set Tablett + Haube



stapel-  
und  
fixierbar



**Buffet-Set „CATERER“**  
buffet set  
set de bufé  
set catering: plateau + cloche



2-teilig: Tablett 11100 + Haube 11003, Tablett fixiert sich auf der Haube - kein Rutschen möglich

2 pcs. set: tray 11100 + cover 11003, tray fixes itself on the cover and can not slip off

set de 2 piezas: bandeja 11100 + tapa 11003, la bandeja encaja encima de la tapa para que no se deslice

ensemble de 2 pièces: plateau GN 1/1 réf. 11100 + cloche 11003 spéciale empilement stable

	cm	cm	GN	€
11195 0	53 x 32,5	10,5	1/1	63,70

**Abdeckhaube GN**  
cover GN  
cubierta GN  
cloche GN



	cm	cm	GN	Materialstärke mm	€
11041 0	32,5 x 26,5	9,5	1/2	3	19,00
11042 7	53,0 x 32,5	9,5	1/1	3	27,00

11041  
GN1/2



11042  
GN1/1



**Haube GN1/1 „HOCHSTAPLER“**  
cover GN1/1 high stacker  
campana GN1/1 especial para apilar  
cloche GN1/1 spéciale empilage



System-Haube für stapelbare Tablettts wie Nr. 11300, 11290 oder 11295

glasklarer Kunststoff, passend zum Tablett 11300, 11290, 11295, Tablett fixiert sich auf der Haube - kein Rutschen möglich, nahezu bruchfest

clear plastic, for tray 11300, 11290, 11295, tray fixes itself on the cover and can not slip off, nearly unbreakable

plástico transparente para bandejas 11300, 11290, 11295, la bandeja se fija a la tapa para que no se deslice, muy resistente a la rotura

en plastique transparent pour plats 11300, 11290, 11295, le plat se fixe sur le dessous de la cloche pour ne pas glisser, très résistant à la casse

	cm	cm	GN	€
11305 3	53 x 32,5	9	1/1	30,00





11150 - mit verchromten Griffen  
11155 - mit vergoldeten Griffen



11160 - mit verchromten Griffen  
11165 - mit vergoldeten Griffen

**System-Tablett „BUFFET-STAR“**  
tray  
bandeja  
plat empilable système catering



Rand hochglanzpoliert, inkl. fest verschraubten Griffen inkl. Distanzstücken, Nutzhöhe 4 cm  
mirror polished finish edge, incl. screwed handles incl. distance pillars, 4 cm distance  
borde pulido efecto espejo, incluye asas atornillables, distanciadores a 4cm  
contour effet miroir, poignées à visser, distance approx. 4 cm

	cm	GN		€
11150 9	53 x 32,5	1/1	mit verchromten Griffen with chrome plated handles con asas cromadas avec poignées chromées	33,00
11155 4	53 x 32,5	1/1	mit vergoldeten Griffen with gold plated handles con asas doradas avec poignées dorées	36,00
11160 8	Ø 48		mit verchromten Griffen with chrome plated handles con asas cromadas avec poignées chromées	46,00
11165 3	Ø 48		mit vergoldeten Griffen with gold plated handles con asas doradas avec poignées dorées	49,00

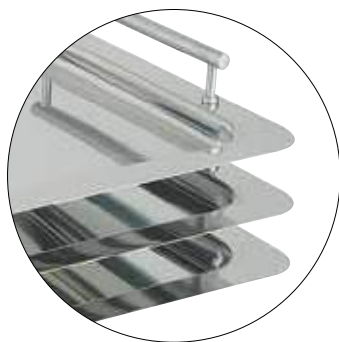

**System-Tablett „CLASSIC“**  
tray  
bandeja  
plat empilable système catering



Rand hochglanzpoliert, mit fest verschraubten Griffen inkl. Distanzstücken, Nutzhöhe 3,5 cm  
mirror polished finish edge, incl. screwed handles incl. distance pillars, 3,5 cm distance  
borde pulido efecto espejo, incluye asas atornillables, distanciadores a 3,5cm  
contour effet miroir, poignées à visser, distance approx. 3,5 cm

	cm	GN		€
11295 7	53 x 32,5	1/1		34,00

**ideal für das  
platzsparende  
Servieren, Lagern  
und Transportieren**

**System-Tablett Set „BUFFET-STAR“**  
tray set  
set bandejas  
ensemble plateau



2-teilig: Tablett mit Griffen zum Stapeln + 1 Lochtablett mit 45 Löchern Ø 3,7 cm (Nr. 11170)  
2 pcs. set: 1 tray with handles, stackable + 1 hole plate with 45 holes Ø 3,7 cm (No. 11170)  
2 piezas: 1 bandeja con asas, apilable + 1 placa con 45 agujeros Ø 3,7 cm (No. 11170)  
2 pièces: plateau 2 anses empilable + plaque 45 trous Ø 3,7 cm (No. 11170)

	cm	GN		€
11168 4	53 x 32,5	1/1		74,00



**Tablett „SWING“**  
tray  
bandeja  
plateau



Rand matt poliert, innen hochglanzpoliert, Nutzhöhe 4 cm, massive Griffe verchromt, inkl. fest verschraubten Distanzstücken

satin polished finish edge, stackable 4 cm, chrome handles, incl. screwed distance pillars

borde pulido efecto satinado, apilable 4 cm, asas cromadas., incl. distanciadores atorillados

contour effet mat, empilable distance 4 cm, poignées chromées, incl. pièces à distance vissées

	cm	GN	€
01425 1	53 x 32,5	1/1	49,00

GN1/1



**Tablett „SWING“**  
tray  
bandeja  
plat



Rand matt poliert, innen hochglanzpoliert

satin polished finish edge, inside mirror polished finish

borde pulido efecto satinado, interior pulido efecto espejo

contour effet mat, intérieur poli miroir



01415

	cm	↑ cm	GN	€
01415 2	28,5 x 20	1	-	18,00
01420 6	53 x 32,5	1	1/1	39,00

01420  
GN1/1



**Tablett „SWING“**  
tray  
bandeja  
plat



Rand matt poliert, innen hochglanzpoliert

satin polished finish edge, inside mirror polished finish

borde pulido efecto satinado, interior pulido efecto espejo

contour effet mat, intérieur poli miroir



	cm	↑ cm	€
01416 9	32,5 x 32,5	1	24,00

designed by **KIRCHHOFF & EUWENS**



**Tablett „SUNDAY“**  
tray  
bandeja  
plateau



hochglanzpoliert  
mirror polished finish  
acabado espejo pulido  
effet brillant

	□ cm	↑ cm	GN	€
11220 9	53 x 32,5	2	1/1	38,00
11210 0	32,5 x 26,5	2	1/2	22,00
11211 7	Ø 46	2	-	46,00

designed by **KIRCHHOFF & EUWENS**



**Tablett „SUNDAY“**  
tray  
bandeja  
plateau



hochglanzpoliert, Griffe inkl. Fixierung, kein Verrutschen möglich, Nutzhöhe 4 cm  
mirror polished finish, with handles for extra secure stacking, distance 4 cm  
pulido espejo, con 2 asas para apilado muy estable, distancia 4 cm entre bandejas  
effet brillant, 2 anses pour empiement très stable, distance 4 cm entre plateaux

	□ cm	↑ cm	GN	€
11222 3	53 x 32,5	6	1/1	52,00
11212 4	32,5 x 26,5	6	1/2	30,00

**Buffet-Tablett**  
buffet-tray  
bandeja de bufé  
plateau buffet



**rund**

Die mehrstufigen Buffet-Tablets sind tolle Blickfänge auf jedem Buffet. Sind einfach zu dekorieren und werden zum echten Hingucker.

perfect for the buffet and party service  
perfecta para el servicio de bufé y fiesta  
idéal pour buffets et catering

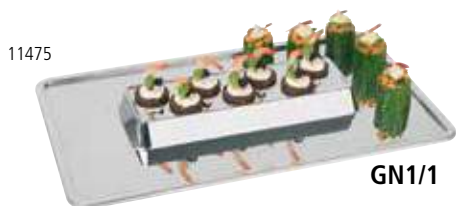

**GN1/1**

	□ cm	↑ cm	GN	€
11470 8	Ø 48	4,5	-	44,00
11475 3	53 x 32,5	3,5	1/1	42,00

**Tablett „BRAZIL“**  
tray  
bandeja de bufé  
plateau buffet



**rund**

Rand hochglanzpoliert, Rand eingerollt, schwere Ausführung  
mirror polished finish edge, rolled edge, high quality  
borde pulido efecto espejo, borde redondeado, alta calidad  
contour poli miroir, bord rond, haute qualité

	□ cm	€
01437 4	Ø 45	42,00



### Tablett „SCHÖNER ESSEN“

tray  
bandeja  
plateau

mit Dekorrand  
with decor edge  
con borde decorado  
bord décor



00086  
00087  
rechteckig,  
abgerundet



00089  
oval

	cm	GN	€
00383 5	35 x 24	-	6,80
00382 8	42 x 31	-	9,80
00381 1	50 x 36	-	14,00
00384 2	63,5 x 44,5	-	27,00
00385 9	60 x 40	-	25,00
00388 0	53,0 x 32,5	1/1	15,40
03824 0	42 x 31	leichte Ausführung 0,5 mm / extra light model 0,5 mm	8,80
03814 1	50 x 36	leichte Ausführung 0,5 mm / extra light model 0,5 mm	10,00
00087 2	38 x 23	rechteckig, abgerundet / rectangular, rounded edge rectangular / rectangulaire	8,00
00086 5	47 x 31	rechteckig, abgerundet / rectangular, rounded edge rectangular / rectangulaire	12,00
00089 6	50 x 39,5	oval	15,00

### Tablett „SCHÖNER ESSEN“

tray  
bandeja  
plateau

mit Dekorrand, Griffe Zinkdruckguss verchromt, genietet  
with decor edge, handles zinc alloy chrome plated, riveted  
borde decorado, asas fundición con zinc  
bord décor, poignées en fonte zinguée



	cm	€
00082 7	52 x 31	15,00
00081 0	60 x 36	20,80
00084 1	75 x 44,5	35,00

### Tablett „SCHÖNER ESSEN“

tray  
bandeja  
plateau

	cm	€
00075 9	Ø 31	6,30
00085 8	Ø 35	8,60





**Tablett mit Haube „SCHÖNER ESSEN“**  
**tray with cover**  
**bandeja con cubierta**  
**plateau avec cloche**



	cm	↑ cm	€
38202 2	42 x 31		14,00

Haube / cover / campana / cloche

08201 4	36,5 x 26,0	7,5	3,90
---------	-------------	-----	------

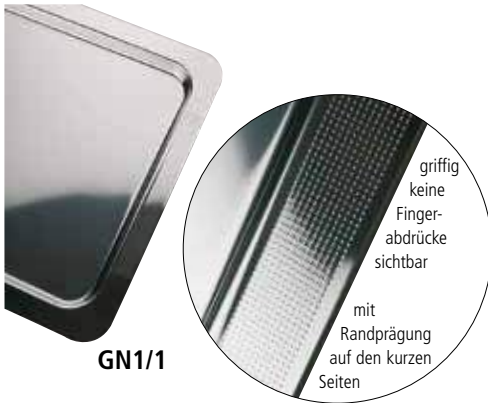

**Tablett „STAR“**  
**tray**  
**bandeja**  
**plat**



Rand hochglanzpoliert mit Prägung  
 polished decor edge  
 borde pulido decorado  
 bords polis miroir, avec relief sur les petits côtés

	cm	GN	€
11115 8	53 x 32,5	1/1	27,50

**Buffet-Tablett „HALBMOND“**  
**tray**  
**bandeja**  
**plat demi-lune**



mit klassischem Linienpräggedekor, passend für Thermoboxen GN1/1 und Thermoporte  
 with decor edge, usable in thermoboxes GN1/1  
 con borde decorado, apto para cajas térmicas GN 1/1  
 bords avec relief, apte pour conteneurs GN 1/1

	cm	GN	€
11111 0	53 x 32,5	1/1	18,00



**Tablett „FINESSE“**  
tray  
bandeja  
plateau



rechteckig



rund



glatter Rand  
plane seam / edge  
borde plano  
bord plat

	cm		€
01314 8	30 x 24	rechteckig / rectangular / rectangulaire	7,80
01313 1	35 x 24	rechteckig / rectangular / rectangulaire	9,00
01317 9	39 x 26	rechteckig / rectangular / rectangulaire	10,20
01312 4	42 x 31	rechteckig / rectangular / rectangulaire	11,50
01318 6	48 x 30	rechteckig / rectangular / rectangulaire	11,00
01311 7	50 x 38	rechteckig / rectangular / rectangulaire	16,00
01310 0	58 x 42	rechteckig / rectangular / rectangulaire	27,00
01309 4	68 x 48	rechteckig / rectangular / rectangulaire	38,00
01332 2	Ø 32	rund / round / redondo / rond	8,60
01335 3	Ø 35	rund / round / redondo / rond	10,20
01338 4	Ø 38	rund / round / redondo / rond	11,50
01348 3	Ø 48	rund / round / redondo / rond	21,40
01349 0	Ø 49,5	rund / round / redondo / rond	22,80
01358 2	Ø 58	rund / round / redondo / rond	49,00

oval



**Tablett „FINESSE“**  
tray  
bandeja  
plateau



glatter Rand / plane seam - edge / borde plano / bord plat

	cm		€
01322 3	42 x 30		13,80
01323 0	50 x 36		20,00
01324 7	60 x 41		28,00
01325 4	70 x 46		40,50

verchromte Messing-Griffe



**Tablett „FINESSE“**  
tray  
bandeja  
plateau



verchromte Messing-Griffe  
chrome plated brass handles  
asas de latón cromadas  
poignées en laiton chromées

	cm		€
01712 2	44 x 31		20,40
01711 5	52 x 38		26,50
01710 8	60 x 42		39,00
01709 2	70 x 48		51,50
01723 8	51 x 36	oval / oval / ovalada / ovale	29,80
01725 2	71,5 x 46	oval / oval / ovalada / ovale	54,70
01738 2	Ø 38 x 2,6	rund / round / redondo / rond	21,10
01748 1	Ø 48 x 2,6	rund / round / redondo / rond	34,60

rund und oval mit verchromten oder vergoldeten Griffen



**Tablett mit Haube „FINESSE“**  
**tray with cover**  
**bandeja con campana**  
**plateau avec cloche**



	cm	↑ cm	€
13122 4	42 x 31	8,5	18,40



**Tablett mit Haube „FINESSE“**  
**tray with cover**  
**bandeja con campana**  
**plateau avec cloche**



	cm	↑ cm	€
13622 9	Ø 22	9,5	6,20



Haubenhöhe  
 11,5 cm oder  
 12,5 cm

13382

**Tablett mit Haube „FINESSE“**  
**tray with cover**  
**bandeja con cubierta**  
**plateau avec cloche**



	cm	↑ cm	€
13382 2	Ø 38	12	19,00
13385 3	Ø 38	13	20,50

**Einzelteile / spare parts / piezas sueltas / pièces détachées**

Frischhalte-Haube / cover / campana / cloche (13382)

06510 9	Ø 30	11,5	4,40
---------	------	------	------

Frischhalte-Haube / cover / campana / cloche (13385)

06515 4	Ø 33	12,5	5,50
---------	------	------	------

**HOT PRICE**



00064  
 Königsuchenplatten

00067  
 Frischhaltebox

**Tablett mit Haube**  
**tray with cover**  
**bandeja con campana**  
**plateau avec cloche**



	cm	↑ cm	€
00064 3	34 x 16,5	10	5,90
00067 4	25 x 19	7	6,40

**Einzelteile / spare parts / piezas sueltas / pièces détachées**

Haube für 00064 / cover for 00064 / campana para 00064 / cloche pour 00064

06401 0			3,00
---------	--	--	------

Haube für 00067 / cover for 00067 / campana para 00067 / cloche pour 00067

06701 1			2,00
---------	--	--	------



**Tablett „ELEGANCE“**  
 tray  
 bandeja  
 plateau



	cm	€
02310 9	41 x 26	12,60
02311 6	48 x 30	16,00
02312 3	60 x 37	24,00



**Tablett mit Haube „ELEGANCE“**  
 tray with cover  
 bandeja con cubierta  
 plateau avec cloche



	cm	€
23642 4	35 x 19	9,00

**HOT PRICE**



**Tortenplatte mit Haube**  
 cake plate with cover  
 bandeja tarta con campana  
 plat à tarte avec cloche



	cm	↑ cm		€
00065 0	Ø 30	11	mit 1 Haube / with 1 cover	6,40
00652 2	Ø 30	7 + 11	mit 2 Hauben / with 2 cover	7,90

7cm Haubenhöhe + 11cm Haubenhöhe



**Tortenplatte „BAROK“**  
 cake plate  
 bandeja tartas  
 plat à gâteau



2-teilig: Tortenplatte mit Barock-Rand + Haube (extra stabil)  
 2 pcs. set: cake plate with decor edge „Barok“ + cover (extra robust)  
 set 2 piezas: porta tartas, borde decor „Barok“ + campana (extra fuerte)  
 set 2 pcs: plateau bord décor „Barok“ + cloche ultra-résistante

	cm	↑ cm	€
06503 1	Ø 32	10	10,00

**Einzelteile / spare parts / piezas sueltas / pièces détachées**

Frischhalte-Haube / cover / campana / cloche

06510 9	Ø 30	11,5	4,40
---------	------	------	------



61400



**Servierpfanne**  
**pan**  
**fuenta 2 asas para la mesa**  
**plat à 2 anses pour la table**



mit vergoldeten Edelstahl-Griffen, 1 mm dick  
 with gold plated handles, 1 mm thickness  
 grosor 1 mm., asas doradas  
 épaisseur 1 mm, poignées dorées

	cm	cm	litr.	€
61400 0	Ø 40	5	4,5	54,60
61150 4	Ø 15	3,5	0,4	12,60
61190 0	Ø 19	3,5	0,7	14,20
61280 8	Ø 28	4	2	20,00
60270 0	26,5 x 19,5	3	0,8	15,80
60310 3	31 x 21,5	3	1,2	19,40
60380 6	37 x 26,5	3	1,7	23,00

61150



60270



mit vergoldeten Edelstahl-Griffen

**Servier- / Beilagenschale**  
**servicing dish**  
**fuenta de servir**  
**plat de service**



mit Edelstahl-Griffen  
 with stainless steel handles  
 asas de acero inoxidable  
 poignées inox

	cm	cm	litr.	€
60275 5	26,5 x 19,5	3	0,8	16,00
60315 8	31 x 21,5	3	1,2	19,40
60385 1	37 x 26,5	3	1,7	23,00

mit Edelstahl-Griffen



**Servier- / Beilagenschale**  
**servicing dish**  
**fuenta de servir**  
**plat de service**



mit Edelstahl-Griffen  
 with stainless steel handles  
 con asas de acero inoxidable  
 poignées inox

	cm	cm	litr.	€
61155 9	Ø 15	3,5	0,4	12,60
61195 5	Ø 19	3,5	0,7	14,20
61285 3	Ø 28	4	2,0	20,00



**HOT  
PRICE**

**Partyplatte  
partytray  
bandeja party  
plateau party**



00393



Innenfläche ziseliert, Rand eingerollt, einzeln mit verkaufsförderndem Farbeinleger  
rolled edge, decorated surface  
borde redondeado, superficie totalmente decorada  
bord rond, surface entièrement ciselée

	cm	VE / Unit		€ / pc.
00393 4	Ø 35	48	rund / round / redondo / rond	3,20
00391 0	46 x 34	48	oval / oval / ovalada / ovale	3,20
00392 7	41 x 31	48	rechteckig / rectangular rectangular / rectangulaire	3,20

00391



	cm	VE	GN	€
00394 1	53 x 32,5	36	1/1	5,20

00392



00934 - GN1/1



nicht säure- und spülmaschinenfest,  
Lebensmittel nur mit  
Papierdeckchenunterlage servieren

metal nickel plated and chrome plated,  
not resistant to food, acidity, oils,  
sauces, not suitable for dishwasher

**HOT  
PRICE**

**Serviertablett „KAFFEEHAUS“  
tray  
bandeja  
plateau**



Rand eingerollt, Innenfläche ziseliert  
rolled edge  
borde redondeado, superficie decor relieve  
bord rond, surface entièrement ciselée

	cm	VE / Unit	€ / pc.
30114 6	30 x 22	48	2,80

**HOT  
PRICE**

2 Größen:  
GN1/1 - 53 x 32,5 cm  
41 x 31 cm

**Partyplatte „CLASSIC“**  
partytray  
bandeja party  
plateau party



mit Liniendekor, Rand eingerollt, patentiertes Design, einzeln im Beutel, mit Farbeinleger  
with line decor, rolled edge, „Patent Design“, with colour inlay  
con filos en relieve, diseño patentado, presentación con foto color  
avec décoration lignée, bord rond, présentation avec photo couleur



	cm	VE / Unit	GN		€ / pc.
00395 8	53 x 32,5	36	1/1	rechteckig / rectangular rectangular / rectangulaire	5,20
00399 6	41 x 31	48	-	rechteckig / rectangular rectangular / rectangulaire	3,20
00389 7	35,4 x 32,5	48	2/3	rechteckig / rectangular rectangular / rectangulaire	3,00
00396 5	Ø 35	48	-	rund / round redondo / rond	3,20
00398 9	46 x 34	48	-	oval / oval oval / ovale	3,20

**nicht säure- und spülmaschinenfest,  
Lebensmittel nur mit  
Papierdeckchenunterlage servieren**

**metal nickel plated and chrome plated,  
not resistant to food, acidity, oils,  
sauces, not suitable for dishwasher**

Servierartikel  
serving items



Nr. 00393 - 96 x  
oder / or / o / ou  
Nr. 00396 - 96 x

Nr. 00391 - 96 x  
oder / or / o / ou  
Nr. 00398 - 96 x

Nr. 00392 - 96 x  
oder / or / o / ou  
Nr. 00399 - 96 x

Nr. 00394 - 72 x  
oder / or / o / ou  
Nr. 00395 - 72 x

**Warenträger  
display  
expositor  
présentoir**

für Partyplatten  
- platzsparende flexible Präsentation durch geringe Abmessungen  
- als Zweitplatzierung für Ihre zusätzlichen Umsätze  
- in weiß lieferbar

for partytrays- space saving presentation- small size- available in white  
para bandejas Party, ocupa poco espacio, disponible en blanco  
pour plateaux Party, occupe très peu d'espace, disponible en blanc

	cm	↑ cm
00397 2	55 x 65	190

**Fischplatte**  
**fish platter**  
**fuate pez**  
**plat poisson**



hochglanzpoliert  
 mirror polished finish  
 acabado efecto espejo  
 finition poili miroir

	cm	cm	€
01328 5	66 x 22,5	2	38,00

designed by **CULTURE FORM**

**Buffet-Brett „FISCH“**  
**board**  
**tabla para el bufé**  
**planche à découper buffet**



Buchenholz, mit Antirutsch-Füßchen  
 beech wood, with non-slip feet  
 haya, pies antideslizantes  
 hêtre, pieds antidérapants

	cm	cm	€
00860 1	76 x 23	2,5	37,00

**Fischplatte „BIG“**  
**fish plate**  
**fuate para pescado**  
**plat creux à poisson**



	cm	cm	€
83996 0	58,5 x 28,0	5,5	28,00

**Tablett „TIMBER“**  
**tray**  
**bandeja**  
**plateau**



84269  
 65 x 26 cm

die Melaminplatten (Holzoptik Fichte) haben eine leichte Struktur und wirken optisch wie aus Holz gefertigt  
 superb spruce wood effect (timber), cutting edge gourmet presentation idea, never produce mould or sawdust, clean and hygienic, no more worries about crack  
 melamina imitación madera de picea, para recetas auténticas  
 mélamine imitation spruce, pour vos recettes authentiques

	cm	cm	€
84269 4	65 x 26	3	30,00

**Tablett „OAK LIGHT“**  
**tray**  
**bandeja**  
**plateau**



84265  
 65 x 26 cm

die Melaminplatten (Holzoptik Eiche) haben eine leichte Struktur und wirken optisch wie aus Holz gefertigt  
 superb oak wood effect, cutting edge gourmet presentation idea, never produce mould or sawdust, clean and hygienic, no more worries about crack  
 melamina imitación madera de roble, para recetas auténticas  
 mélamine imitation chêne, pour vos recettes authentiques

	cm	cm	€
84265 6	65 x 26	3	30,00



**Bratenplatte „HIGH LINE“**  
**meat platter**  
**fuente servicio**  
**plat de service**



hochglanzpoliert  
 oval

hochglanzpoliert, Rand eingerollt  
 mirror polished finish, rolled edge  
 acabado pulido efecto espejo, borde redondeado  
 poli miroir, bord rond

	cm	€
30004 0	31 x 22	11,80
30005 7	41,5 x 30	18,00
30006 4	46,5 x 33,5	25,00



oval

**Bratenplatte „ECO LINE“**  
**meat platter**  
**fuente servicio**  
**plat de service**



poliert, Rand eingerollt  
 polished, rolled edge  
 pulido, borde redondeado  
 poli miroir, bord rond

	cm	€
30100 9	25 x 18	7,00
30101 6	30 x 22	9,00
30102 3	35 x 22	11,00
30103 0	40 x 26	16,20
30104 7	45 x 30	19,00
30105 4	50 x 35	27,00



**Tablett**  
**tray**  
**bandeja**  
**plateau**



mit gebördeltem, polierten Rand  
 rolled and mirror polished edge  
 borde redondeado acabado efecto espejo  
 bord rond, effet miroir

	cm	↑ cm	€
01336 0	Ø 35	3	26,00

**Buffetständer**  
**seafood stand**  
**soporte para marisco**  
**pied à fruits de mer**



für Tablett 01336  
 for tray 01336  
 para bandeja 01336  
 pour plateau 01336

74207 9	Ø 20 - 25	19	11,00
---------	-----------	----	-------



74207



01336



**Servier- / Tortenplatte**  
**cake stand**  
**soporte para pastel**  
**présentoir à gâteaux**



hochglanzpoliert, mit hohem Fuß (fest verbunden)  
 mirror polished finish, with tall foot  
 acabado brillante, con pie alto  
 poli brillant, pied haut

	cm	cm	€
00466 5	Ø 34,5	13,5	49,00

**Einzelteile / spare parts / piezas sueltas / pièces détachées**

Frischhalte-Haube / cover / campana / cloche

06517 8	Ø 33	12,5	6,90
---------	------	------	------

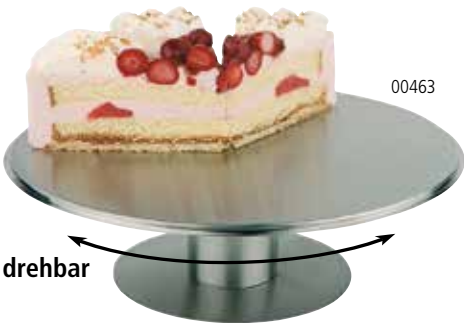

**Servierplatte / Tortenplatte „INOX“**  
**plate / cake plate**  
**porta tartas**  
**guéridon à gâteau**



matt poliert, drehbar, möbelschonende Moosgummi-Unterseite  
 satin polished finish, rotating, foam rubber below to save your furniture  
 acabado pulido satinado, giratorio, base revestida de goma para no rallar el mobiliario  
 poli satiné, plateau tournant, revêtement mousse sous le pied pour ne pas rayer les meubles

	cm	cm	€
00463 4	Ø 30,5	9	38,00



**Einzelteile / spare parts / piezas sueltas / pièces détachées**



Frischhalte-Haube / cover / campana / cloche

06510 9	Ø 30	11,5	4,40
---------	------	------	------



**Servierplatte / Tortenplatte**  
**plate / cake plate**  
**porta tartas**  
**guéridon à gâteau**



Fuß matt poliert, drehbar, möbelschonende Moosgummi-Unterseite  
 foot satin polished finish, rotating, foam rubber below to save your furniture  
 vidrio, pie inox satinado giratorio, base de goma para proteger el mobiliario  
 plateau en verre, pied tournant inox poli satin, revêtement mousse sous le pied anti-rayures

	cm	cm	€
00444 3	Ø 30	7	18,90



**Servierplatte**  
**plate**  
**porta tarta**  
**guéridon à gâteau**



Fuß matt poliert, stabil und sehr standsicher  
 foot satin polished finish  
 pie pulido con efecto satinado  
 inox poli satin

	cm	cm	€
00464 1	Ø 30	11	18,50



**Tortenplatte**  
**cake plate**  
**porta tarta**  
**guéridon à gâteau**



Fuß hochglanzpoliert, Platte matt poliert, stabil und sehr standsicher  
 foot mirror polished finish, plate satin polished finish  
 pie pulido brillante, bandeja pulida mate  
 pied brillant, plateau poli satin mat

	□ cm	↑ cm	€
00462 7	Ø 30	11	42,00

**Einzelteile / spare parts / piezas sueltas / pièces détachées**



Frischhalte-Haube / cover / campana / cloche

06510 9	Ø 30	11,5	4,40
---------	------	------	------

**Konditorplatte**  
**cake plate**  
**porta tartas confitería**  
**plateau à gâteaux avec pied**



matt poliert  
 satin polished finish  
 acabado efecto satinado  
 poli mat effet satin

	□ cm	↑ cm	€
00046 9	Ø 31	3	12,50

**Tortenplatte**  
**cake tray**  
**bandeja para tarta**  
**plat à tarte**



00468

Rand fixiert die Haube, mit Antirutsch-Füßchen  
 carved edge fixes the cover, non-slip feet  
 ranura para fijar bien la campana, pies antideslizantes  
 bord rainuré pour maintenir ferme la cloche, pieds antiglisse

	□ cm	↑ cm	€
00468 9	Ø 31	4	15,00
00469 6	Ø 31	4	15,00



00469

**Einzelteile / spare parts / piezas sueltas / pièces détachées**



Frischhalte-Haube / cover / campana / cloche

06510 9	Ø 30	11,5	4,40
---------	------	------	------

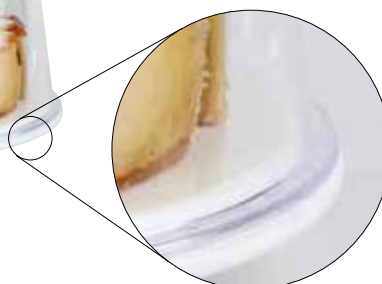

**Abgesenkter Rand fixiert die Haube und vereinfacht das Abheben von Tortenstücken. Kein Abrutschen der Haube.**



**Tablett „BAKERY“**  
tray  
bandeja  
plateau



	cm	↑ cm		€
15130 7	Ø 18,5	1,5	○	8,40
15131 4	Ø 23,5	1,5	○	13,00
15132 1	Ø 35	1,5	○	26,00
15133 8	Ø 42,5	1,5	○	39,00



**Tortenplatte mit Haube**  
cake plate with cover  
bandeja tarta con campana  
plat à tarte avec cloche



	cm	↑ cm		€
00065 0	Ø 30	11	mit 1 Haube / with 1 cover	6,40
00652 2	Ø 30	7 + 11	mit 2 Hauben / with 2 cover	7,90

7cm Haubenhöhe + 11cm Haubenhöhe



**Tortenplatte „BAROK“**  
cake plate  
bandeja tartas  
plat à gâteau



2-teilig: Tortenplatte mit Barock-Rand + Haube (extra stabil)  
2 pcs. set: cake plate with decor edge „Barok“ + cover (extra robust)  
set 2 piezas: porta tartas, borde decor „Barok“ + campana (extra fuerte)  
set 2 pcs: plateau bord décor „Barok“ + cloche ultra-résistante

	cm	↑ cm		€
06503 1	Ø 32	10		10,00

**Einzelteile / spare parts / piezas sueltas / pièces détachées**

Frischhalte-Haube / cover / campana / cloche

06510 9	Ø 30	11,5		4,40
---------	------	------	--	------



**Tablett mit Haube**  
tray with cover  
bandeja con campana  
plateau avec cloche



	cm	↑ cm		€
00064 3	34 x 16,5	10		5,90
00067 4	25 x 19	7		6,40

**Einzelteile / spare parts / piezas sueltas / pièces détachées**

Haube für 00064 / cover for 00064 / campana para 00064 / cloche pour 00064

06401 0				3,00
---------	--	--	--	------

Haube für 00067 / cover for 00067 / campana para 00067 / cloche pour 00067

06701 1				2,00
---------	--	--	--	------



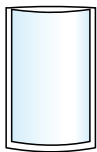

doppelwandig  
double wall

**Thermo-Sauciere**  
**insulated sauce boat**  
**salsera isotérmica**  
**saucière thermique**



doppelwandig, Klappdeckelverschluss, Einhandbedienung  
double wall, hinged cover, one-hand operation  
doble pared, tapa con bisagra, se maneja con 1 mano  
double paroi, couvercle avec charnière, usage 1 main

	□ cm	↑ cm	ltr.	€
40207 2	19 x 12,5	13	0,4	14,40



4 Größen



40208

**Sauciere**  
**gravy boat**  
**salsera**  
**saucière**



hochglanzpoliert, extra schwere Qualität  
mirror polished finish, high quality  
acabado efecto espejo, alta calidad, base pesada  
poli brillant, belle qualité, pied pesant

NEW

	□ cm	↑ cm	ltr.	€
40208 9	13 x 6	9,0	0,10	6,00
40204 1	16 x 7,5	9,0	0,15	6,70
40205 8	19 x 9,0	13,0	0,25	8,70
40206 5	22 x 10,5	13,5	0,45	11,00



40204



**Sauciere**  
**gravy boat**  
**salsera**  
**saucière**



poliert  
polished  
pulido  
poli

4 Größen

	□ cm	↑ cm	ltr.	€
40200 3	14 x 6	7	0,1	4,60
40201 0	22 x 9,5	10	0,2	5,60
40202 7	20 x 9	10,5	0,3	6,70
40203 4	17 x 7,5	8,7	0,15	5,40





**Butterservierer  
butter dish  
mantequillera  
beurrier**



hochglanzpoliert  
mirror polished finish  
acabado brillante  
poli brillant

	cm	cm	€
15921 1	Ø 9	7	12,60

**Butterservierer  
butter dish  
mantequillera  
beurrier**



15925

15926

	cm	cm	€
15925 9	Ø 9	9	7,00
15926 6	9 x 9	9	7,00

**Butterdose  
butter dish  
mantequillera  
beurrier**



	cm	cm	€
00062 9	18,5 x 12,5	5	10,50



**Kühlschrank-Butterdose  
refrigerator butter dish  
mantequillera para nevera  
boîte à beurre pour le frigo**



	cm	cm	€
00063 6	16 x 9,5	5,5	2,40

**NEW**

für ca. 20 Eier



**Eier-Korb „PROFI LINE“**  
egg basket  
cesta de huevos  
panier à oeufs



mit Edelstahldraht im Rand, für ca. 20 Eier, hält den Inhalt durch das Stoff-Futter lange warm  
willow, stable, for around 20 eggs, keeps eggs warm  
ratán, calidad fuerte, para unos 20 huevos, mantiene los huevos calientes  
rotin, résistant, belle qualité, pour environ 20 oeufs, pour maintenir les oeufs bien chauds

	□ cm	↑ cm		€
40299 7	Ø 26	17	●	16,00

Servierartikel  
serving items

für ca. 20 Eier



**Eier-Korb**  
egg basket  
cesta de huevos  
panier à oeufs



stabile Vollweide, hält den Inhalt durch das sehr dicht verarbeitete Stoff-Futter lange warm  
willow, stable, keeps eggs warm  
ratán, calidad fuerte, mantiene los huevos calientes  
rotin, résistant, belle qualité, pour maintenir les oeufs bien chauds

	□ cm	↑ cm		€
30299 0	Ø 26	17		13,00

designed by **KIRCHHOFF & EUWENS**



**Eierbecher, 4er Set**  
egg holder, 4pcs. set  
huevera, set de 4 unidades  
coquetier, pack de 4



	□ cm	↑ cm	pcs.	€
83851 2	Ø 8	3	4	6,40



**4er Set  
weiß**  
83848

**Eierbecher, 4er Set**  
egg holder, 4 pcs. set  
huevera, set de 4 unidades  
coquetier, pack de 4



	□ cm	↑ cm	pcs.	€
83848 2	Ø 8,5	2	4	5,90



**Eierbecher**  
egg holder  
huevera  
coquetier



hochglanzpoliert / mirror polished finish / acabado pulido efecto espejo / effet miroir

	□ cm	↑ cm		€
00032 2	Ø 8,5	2		1,60



**Glocke**  
**cloche / dome cover**  
**campana esférica**  
**cloche demi-sphère**



außen hochglanzpoliert, innen matt poliert, mit verchromten Griff  
 outside mirror polished finish, inside satin polished finish, with chromeplated handle  
 exterior pulido acabado efecto espejo, interior pulido acabado efecto satinado, pomo cromado  
 extérieur poli brillant, intérieur poli satin, bouton chromé

	☐ cm	↑ cm	€
35734 1	Ø 29	18	44,00



**Platzteller**  
**plate tray**  
**bajo plato**  
**assiette de présentation**



Rand eingerollt  
 rolled edge  
 borde redondeado  
 bord rond

	☐ cm	€
35930 7	Ø 31	matt poliert / satin polished finish acabado efecto satinado / fini mat effet satin 14,20
35735 8	Ø 31	hochglanzpoliert / mirror polished pulido brillante / poli brillant 15,00



**Fadendekor**

**Platzteller**  
**plate tray**  
**bajo plato**  
**assiette de présentation**



hochglanzpoliert, mit Fadendekor  
 mirror polished finish, with line edge  
 pulido efecto espejo, con un filo en relieve  
 poli miroir, filet relief

	☐ cm	€
35730 3	Ø 30,5	14,40
36233 8	Ø 33	19,20



**Perlrund**

**Platzteller**  
**plate tray**  
**bajo plato**  
**assiette de présentation**



hochglanzpoliert, mit Perlrund  
 mirror polished finish, with pearl edge  
 acabado pulido efecto espejo, con borde aperlado  
 poli miroir, bord perlé

	☐ cm	€
35720 4	Ø 30,5	14,60
36323 6	Ø 33	18,20



**2 Größen**  
**Ø 10 cm für Gläser**  
**Ø 11,5 cm für Flaschen**



35912  
**Rand eingerollt**

**Untersetzer**  
**coaster**  
**posavazos**  
**plateau sous-verre**



hochglanzpoliert, schwere Ausführung, Rand eingerollt  
 mirror polished finish, heavy quality, rolled edge  
 acabado pulido efecto espejo, alta calidad, borde redondeado  
 effet miroir, bord rond, qualité extra

	cm	pcs.		€
35711 2	Ø 10	6	für Gläser / for glasses para vasos / pour verres	14,40
35712 9	Ø 11,5	2	für Flaschen / for bottles para botellas / pour bouteilles	6,70
35912 3	Ø 12	6		13,90



**Rechnungstablett, 2er Set**  
**bill presenter, 2 pcs. set**  
**set 2 piezas para presentar cuenta**  
**porte-addition, set de 2 pièces**



1 Edelstahl-Tablett hochglanzpoliert + 1 klappbare Ledermappe mit Stiftflasche,  
 mit Magnethalterung  
 1 stainless tray mirror polished finish + 1 leather presenter, with magnetic system  
 1 bandeja de acero inoxidable pulido brillante + 1 presentador de cuero con sistema  
 magnético  
 1 plateau inox poli brillant + 1 pochette cuir aimantée

	cm	↑ cm	€
30109 2	20 x 16	2	24,40

**mit Klemme für**  
**Rechnungen**



**Rechnungstablett**  
**bill tray**  
**bandeja porta-cuenta**  
**plateau addition**



	cm	↑ cm	€
30110 8	17 x 11	1	5,80



**Rechnungstablett**  
**bill presenter**  
**presentar cuenta**  
**porte-addition**



	cm	↑ cm	€
30107 8	16,5 x 11,5	0,5	1,40



**Rechnungstablett**  
**bill presenter**  
**presentar cuenta**  
**porte-addition**



mit Klemme für Rechnung  
 with clip for bill  
 con clip para la nota  
 avec clip pour la note

	cm	↑ cm	€
30108 5	20,0 x 12,0	0,5	1,70



**Tablett „BISTRO“**  
tray  
bandeja  
plateau



rutschfest, hoher Rand  
non-slip, high edge

rutschfest, mit 2 Griffmulden und Stapelrand  
non-slip, two open handles, stackable edge  
anti-deslizante, 2 asas  
antidérapant, 2 anses

	☐ cm	↑ cm		€
84045 4	Ø 35,5	4,5	●	22,00



3 Größen  
3 sizes



rutschfest  
non-slip

**Tablett „GASTRO“**  
tray  
bandeja  
plateau



rutschfeste Oberfläche  
non-slip surface  
superficie anti-deslizante  
surface antidérapante

	☐ cm	↑ cm		€
00547 1	Ø 27,5	2	●	6,90
00548 8	Ø 35,5	2	●	8,70
00549 5	Ø 40,5	2	●	10,50

**Serviertablett „HAPPY HOUR“**  
tray  
bandeja  
plateau



rutschfest, glasfaserverstärktes Polyester, rutschfeste Naturkautschukbeschichtung  
non-slip, fibreglass reinforced polyester, natural rubber coating  
antideslizante, poliéster fibra de vidrio, revestido caucho natural  
antiglisse, polyester renforcé avec fibre de verre, revêtement caoutchouc naturel

	☐ cm	↑ cm		€
00510 5	Ø 32	1,5	● schwarz / black	20,60
00511 2	Ø 38	1,5	● schwarz / black	25,00
00512 9	Ø 38	1,5	● rot / red	25,00
00513 6	Ø 38	1,5	● blau / blue	25,00
00515 0	Ø 43	1,5	● schwarz / black	28,90



**Serviertablett „RUTSCHFEST“**  
**tray non-slip**  
**bandeja antideslizante**  
**plateau antiglisse**



glasfaserverstärktes Polyester, rutschfeste Naturkautschukbeschichtung  
 fiberglass reinforced polyester, non-slip natural rubber coating  
 antideslizante, poliéster fibra de vidrio, revestido caucho natural  
 antiglisse, polyester renforcé avec fibre de verre, revêtement caoutchouc naturel

	cm	↑ cm	GN		€
00502 0	53,0 x 32,5	1,5	1/1	●	24,00
00508 2	46 x 36	2		●	23,00
00505 1	53,0 x 32,5	1,5	1/1	●	24,00
00503 7	53 x 37	1,5		●	27,80



**Fast Food-Tablett**  
**snack tray**  
**bandeja autoservicio y snacks**  
**plateau self-service et snacks**



	cm	↑ cm		€	
00530 3	35 x 27	2	●	3,30	
00531 0	35 x 27	2	●	3,30	
00532 7	35 x 27	2	●	3,30	
00533 4	35 x 27	2	●	3,30	
00535 8	41 x 30,5	2	●	4,40	
00536 5	41 x 30,5	2	●	4,40	
00537 2	41 x 30,5	2	●	4,40	
00538 9	41 x 30,5	2	●	4,40	
00540 2	45 x 35,5	2	●	5,60	
00541 9	45 x 35,5	2	●	5,60	
00542 6	45 x 35,5	2	●	5,60	
00543 3	45 x 35,5	2	●	5,60	
			GN		
<b>NEW</b> 00552 5	53,0 x 32,5	2	1/1	●	6,60
<b>NEW</b> 00553 2	53,0 x 32,5	2	1/1	●	6,60
<b>NEW</b> 00554 9	53,0 x 32,5	2	1/1	●	6,60
<b>NEW</b> 00555 6	53,0 x 32,5	2	1/1	●	6,60





**Serviertablett „COOL“**  
tray  
bandeja  
plateau



rutschfeste Oberfläche  
non-slip surface  
superficie antideslizante  
surface antidérapante

	cm	cm		€
00551 8	Ø 35,5	2	weiß / schwarz / braun white / black / brown	6,60



**Serviertablett „FLASH“**  
tray  
bandeja  
plateau



rutschfeste Oberfläche  
non-slip surface  
superficie antideslizante  
surface antidérapante

	cm	cm		€
00550 1	Ø 35,5	2	schwarz / weiß black / white	6,60



00500  
rund

**Bierglasträger „RUTSCHFEST“**  
tray non-slip  
bandeja antideslizante  
plateau antiglisse



glasfaserverstärktes Polyester, rutschfeste Naturkautschukbeschichtung, -50°C bis +140°C  
fiberglass reinforced polyester, -50°C to +140°C, natural rubber coating  
poliester reforzado con fibra de vidrio desde -50°C hasta +140°C  
polyester renforcé avec fibre de verre, revêtement caoutchouc naturel, résistant -50°C à +140°C

	cm	cm		€	
00500 6	Ø 36	3,5	●	rund - anthrazit / round - anthracite rendonda-antracita / rond - anthracite	19,00
00501 3	Ø 36	3,5	●	rund - grau / round - grey redonda-gris / rond - gris	19,00
00506 8	28 x 20	1,5	●	oval - anthrazit / oval - anthracite oval-antracita / ovale - anthracite	8,50
00507 5	28 x 20	1,5	●	oval - grau / oval - grey oval-gris / ovale - gris	8,50

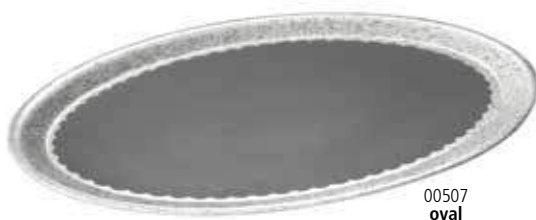

00507  
oval



00506  
oval



4 Größen / 4 sizes



oval



**Tablett oval  
tray oval  
bandeja  
plateau**



rutschfest, Holzdekor-Laminat  
non-slip, coated wood  
antideslizante  
antidérapant

	□ cm	↑ cm		€
00520 4	23,0 x 16,0	1,0		7,80
00521 1	26,0 x 20,0	1,0		8,00
00522 8	29,0 x 21,0	1,0		10,50
00523 5	38,0 x 27,0	1,5		15,00

**rutschfest  
non-slip**

**Tablett rund  
tray  
bandeja  
plateau**



rutschfest, Woodform, Mahagoni  
non-slip, woodform, mahogany  
antideslizante  
antidérapant



00528  
Ø 31 cm

3,5 cm



00529  
Ø 35,5 cm

3,5 cm

	□ cm	↑ cm		€
00528 0	Ø 31	3,5	hoher Rand	18,00
00529 7	Ø 35,5	3,5	hoher Rand	23,00
00527 3	Ø 32	1,5	flacher Rand, Holzdekor-Laminat	14,50



00527  
Ø 32 cm

**flacher Rand / flat edge**

3 Größen / 3 sizes



00526

**Tablett rechteckig  
tray  
bandeja  
plateau**



rutschfest, Holzdekor-Laminat  
non-slip, coated wood  
antideslizante  
antidérapant

	□ cm	↑ cm		€
00524 2	43,5 x 31,5	1,5		18,00
00525 9	52,0 x 39,0	1,5		22,80
00526 6	60,5 x 42,5	1,5		28,90

designed by **CULTURE FORM**

**Serviertablett „KAFFEEHAUS“**  
tray  
bandeja  
plateau



84251

	cm	↑ cm		€
84250 2	26,0 x 20,0	1,5	○	4,20
84252 6	28,5 x 21,5	1,5	○	4,80
84251 9	26,0 x 20,0	1,5	●	4,20
84253 3	28,5 x 21,5	1,5	●	4,80

**rutschfeste Oberfläche**  
**non-slip surface**  
**superficie antideslizante**  
**surface antidérapante**



84252

designed by **CULTURE FORM**

**Serviertablett „KAFFEEHAUS“**  
tray  
bandeja  
plateau



30126 + 30127  
**mattiert**

	cm	↑ cm		€
30126 9	25,5 x 19,5	2	mattiert / satin polished finish acabado efecto satinado / fini mat effet satin	6,30
30127 6	30 x 23	2	mattiert / satin polished finish acabado efecto satinado / fini mat effet satin	8,50
30136 8	25,5 x 19,5	2	hochglanzpoliert / mirror polished finish acabado espejo pulido / poli brillant miroir	6,30
30137 5	30 x 23	2	hochglanzpoliert / mirror polished finish acabado espejo pulido / poli brillant miroir	8,50



30136 + 30137  
**hochglanzpoliert**



**stabiler eingerollter Rand**

**Serviertablett „KAFFEEHAUS“**  
tray  
bandeja  
plateau



matt poliert, Rand eingerollt  
satin polished finish, rolled edge  
acabado pulido satinado, borde redondeado  
effet satin mat, bord rond

	cm	↑ cm	€
30119 1	23 x 23	1,5	8,50



stabiler eingerollter Rand

**Serviertablett „KAFFEEHAUS“**  
tray  
bandeja  
plateau

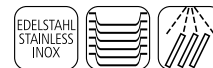

matt poliert, Rand eingerollt  
satin polished finish, rolled edge  
acabado pulido efecto satinado, borde redondeado  
effet satin, bord rond

	cm	↑ cm	€
30118 4	21,5 x 13	1,5	6,70



matt poliert / satin polished

**Serviertablett „KAFFEEHAUS“**  
tray  
bandeja  
plateau



matt poliert, oval, Rand eingerollt  
satin polished finish, oval, rolled edge  
pulido acabado efecto satinado, oval, borde redondeado  
effet satin, ovale, bord rond

	cm	↑ cm	€
30111 5	19 x 15	1	für Zucker und Sahne / for sugar and cream para azúcar y crema / pour le sucre et la crème 4,30
30112 2	26,5 x 19	1	für eine Tasse / for one cup para una taza / pour une tasse 6,50
30113 9	29 x 22	1	für zwei Tassen / for two cups para dos tazas / pour deux tasses 6,90
30123 8	23 x 17,5	1	Eisdielen-Größe / icecream pralor size tamaño especial para heladerías / taille spéciale pour glaciers 6,10



hochglanzpoliert / mirror polished

hochglanzpoliert, oval, Rand eingerollt  
mirror polished finish, oval, rolled edge  
pulido efecto espejo, ovalado, borde redondeado  
effet brillant, ovale, bord rond

30115 3	19 x 15	1	für Zucker und Sahne / for sugar and cream para azúcar y crema / pour le sucre et la crème 4,30
30116 0	26,5 x 19	1	für eine Tasse / for one cup para una taza / pour une tasse 6,50
30117 7	29 x 22	1	für zwei Tassen / for two cups para dos tazas / pour deux tasses 6,90
30124 5	23 x 17,5	1	Eisdielen-Größe / icecream pralor size tamaño especial para heladerías / taille spéciale pour glaciers 6,10



**Serviertablett „KAFFEEHAUS“**  
tray  
bandeja  
plateau



Rand eingerollt, Innenfläche ziseliert  
rolled edge  
borde redondeado, superficie decor relieve  
bord rond, surface entièrement ciselée

	cm	VE / unit	€ / pc.
30114 6	30 x 22	48	2,80



**Kühlschale, 2-teilig „COOL“**  
**cool bowl, 2 pcs. set**  
**bol refrigerado, 2 pz.**  
**set de 2 bols réfrigérés**

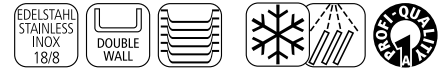

2-teilig, doppelwandig, Schale ist mit Kühlmittel gefüllt und wird zum Aufladen in das Gefrierfach gelegt, endlos verwendbar

2 pcs., 1 pc. double wall ice bowl filled with freezer-liquid, 1 pc. stainless bowl

bol isotérmico, doble pared que contiene un líquido refrigerante, acumula el frío en el congelador para luego mantener fríos los alimentos, para usos repetitivos

bol isotherme, double paroi qui contient un liquide réfrigérant, accumule le froid du congélateur pour ensuite maintenir froids les aliments, pour usages répétés



	□ cm	↑ cm	ltr.	€
30023 1	Ø 23	10,5	1	42,00



**Einzelteile / spare parts / piezas sueltas / pièces détachées**

Deckel „FLOAT“, mit Löffelaussparung / cover, with notched for spoons / tapa, con espacio para la cuchara / couvercle, avec encoche pour la louche

83920 5	Ø 20,5	1,3		8,20
---------	--------	-----	--	------



83920  
passender Deckel

**Kühldauer bis  
zu 3 Stunden**



**Kaviarkühler**  
**caviar cooler**  
**enfriador de caviar**  
**rafraîchisseur de caviar**



4-teilig; Glasschale Ø 10 cm

4 pcs., glass bow Ø 10 cm

4 piezas, bol Ø 10 cm

4 éléments, bol Ø 10 cm

	□ cm	↑ cm	€
01699 6	Ø 18	12	49,90



**Serviertopf Muschel**  
**mussel port**  
**mejillonera**  
**casserole à moules**



schwarz emailliertes Stahlblech, mit Edelstahlrand

black enamelled steel, stainless steel rim

hierro esmaltado negro, borde inox

acier émaillé noir, bord inox

**Topf darf nicht erhitzt werden!**  
**Topf ist nicht zum Kochen geeignet!**

	□ cm	↑ cm	ltr.	€
00623 2	Ø 13,5	9	0,8	5,60
00625 6	Ø 18	12	2,0	9,60
00626 3	Ø 20	13	3,0	10,20
00627 0	Ø 24	13,5	4,0	12,00

**NEW**40642  
0,07 ltr.40644  
0,36 ltr.**3 Größen**  
**3 sizes****Stielkasserolle / Serviertopf**  
**sauté pan / mini sauce pan**  
**cazo recto bajo**  
**plat à sauter**

	□ cm	↑ cm	ltr.		€
40642 1	Ø 5	3	0,07	Griff: 6 cm / handle: 6 cm asa: 6 cm / poignée: 6 cm	4,40
40643 8	Ø 7	4,5	0,14	Griff: 9 cm / handle: 9 cm asa: 9 cm / poignée: 9 cm	5,00
40644 5	Ø 9	6	0,36	Griff: 9 cm / handle: 9 cm asa: 9 cm / poignée: 9 cm	7,90

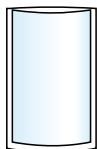
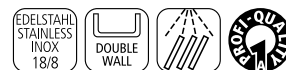
doppelwandig  
double wall**3 Größen**  
**3 sizes****Edelstahlschale, doppelwandig**  
**stainless bowl, double wall**  
**bol inox doble pared**  
**bol inox double paroi**beste Isoliereigenschaften  
best insulating properties  
muy aislante  
très isolant

	□ cm	↑ cm	ltr.	€
30040 8	Ø 14	6,5	0,5	17,80
30041 5	Ø 20	9	1,5	23,00
30042 2	Ø 23	10	2,5	29,00

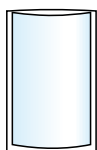
doppelwandig  
double wall**1,8 ltr.****Dressingtopf, doppelwandig**  
**bowl, double wall**  
**salsera alta, doble pared**  
**pot à sauce, double paroi**beste Isoliereigenschaften  
best insulating properties  
muy aislante  
très isolant

	□ cm	↑ cm	ltr.	€
30043 9	Ø 15	18	1,8	41,00

**6 Löffel****Gourmetlöffel, 6er Set**  
**gourmet spoons, 6 pcs. set**  
**cucharas gourmet, el pack de 6**  
**cuillères gourmet, le pack de 6**hochglanzpoliert, zur Präsentation von Vorspeisen  
mirror polished finish, perfect to present appetiser  
acabado brillante, perfecto para presentar aperitivos  
poli brillant, parfait pour les apéritifs et entrées

	□ cm	pcs.	€
00682 9	11 x 4	6	12,00



**Dressingtopf „CASUAL“**  
 dressing pot  
 salsaera alta  
 saucière



	□ cm	↑ cm	ltr.		€
83867 3	Ø 12	21,5	1	○	24,00
83868 0	Ø 12	21,5	1	●	24,00

mit Antirutsch-Füßchen  
 non-slip feet  
 con pies antideslizantes  
 avec pieds antidérapants



**Dressingtopf**  
 dressing pot  
 salsaera  
 pot à sauce



Deckel mit Löffelaussparung  
 cover notched for spoon  
 tapa agujereada para el cucharón  
 couvercle avec espace pour la louche

	□ cm	↑ cm	ltr.	€
83309 8	Ø 18,5	17	2,3	22,00
83310 4	Ø 17	15	2,0	21,00
83311 1	Ø 13	13	0,8	11,00



**Servier- / Buffetplatte**  
 dish  
 bandeja bufé  
 plat buffet



	□ cm	↑ cm	GN	€
83301 2	53 x 32,5	2	1/1	42,00
83305 0	32,5 x 26,5	2	1/2	25,80
83304 3	32,5 x 17,5	2	1/3	16,00
83303 6	53 x 16,2	2	2/4	29,00

83301 - GN1/1



83305 - GN1/2



83304 - GN1/3



83303 - GN2/4

Buffet & Banquet . Cerealienspender . Etagèren . Kühlshalen . Kannen . Saftdispenser  
buffet & banquet . cereal dispenser . etagèren . cool bowls . pitcher . juice dispenser  
bufé y catering . dispensadores de cereales . expositores . boles refrigerados . jarras . dispensadores de zumos  
buffet et catering . distributeurs de céréales . présentoirs . bols réfrigérés . pichets . distributeurs de jus de fruits

# BUFFETSYSTEM „SUPERBOX“



Buffetsystem „Superbox“ ist ein multifunktionales Buffetsystem, das sich in Höhe und Breite allen Platzanforderungen anpasst. Die stapelbaren Wendeboxen lassen sich rutschfest stapeln und mit flachen GN Platten verbinden und einzeln nutzen. Individuell können Buffetlandschaften gebaut werden.

„Superbox“ is a multifunctional buffet system that adapts in height and width to all space requirements. The stackable and non-slip reversible boxes can be connected to flat GN trays and can also be used individually. Different and individual buffet sceneries can be built up.



11626

„Wendebox“  
(180° Grad)

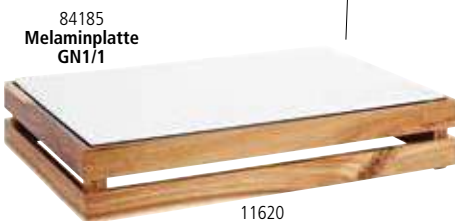

84185  
Melaminplatte  
GN1/1

11620



00990  
Schieferplatte  
GN1/1

11626

## Superbox GN1/1



Akazienholz / acacia wood / madera de acacia / bois d'acacia

Wendebox: als klassische Buffet-Box sowie GN-Platten-Buffetbox einsetzbar  
reversible box - can be used as a normal box or to build up different buffet sceneries  
caja girable - se puede utilizar como una caja o para construir diferentes paisajes de bufé  
boîte de tournage - se peut utilisée comme une boîte ou pour construire des paysages de buffet

	cm	↑ cm		€
11620 7	55,5 x 35,0	10,5	● hellbraun / light brown	29,00
11626 9	55,5 x 35,0	10,5	● schwarz / black	29,00

## passende GN1/1 Platten / suitable GN1/1 trays / accesorios / accessoires

	cm	GN		€
00990 5	53,0 x 32,5	1/1	Schieferplatte / slate tray	15,00
84185 7	53,0 x 32,5	1/1	○ Melaminplatte weiß / melamin plate white	34,00
84195 6	53,0 x 32,5	1/1	● Melaminplatte schwarz / melamin plate black	34,00





„Superbox“ es un sistema de bufé multifuncional que se adapta en altura y anchura a todos los requisitos de espacio. Las cajas girables y apilables son antideslizantes y se pueden conectar con bandejas planas GN o utilizar individualmente. Se pueden construir diferentes paisajes de bufé muy individuales.

„Superbox“ est un système de buffet multifonctionnel qui s'adapte en hauteur et en largeur à toutes les exigences de l'espace. Les boîtes de tournage empilables sont antiglissantes et peuvent être connectées avec des plateaux plats GN ou utilisées individuellement. Des paysages de buffet très personnalisés peuvent être construits.

**NEW**



11623



### Superbox GN2/4



Akazienholz / acacia wood / madera de acacia / bois d'acacia

Wendebox: als klassische Buffet-Box sowie GN-Platten-Buffetbox einsetzbar

reversible box - can be used as a normal box or to build up different buffet sceneries

caja girable - se puede utilizar como una caja o para construir diferentes paisajes de bufé

boîte de tournage - se peut utilisée comme une boîte ou pour construire des paysages de buffet

	cm	↑ cm		€
11623 8	55,5 x 18,5	10,5	● hellbraun / light brown	24,00
11629 0	55,5 x 18,5	10,5	● schwarz / black	24,00

### passendes Zubehör / suitable accessories / accesorios a juego / accessoires assortis

	cm	GN		€
00973 8	53,0 x 16,2	2/4	Schieferplatte / slate tray	6,00
84189 5	53,0 x 16,2	2/4	○ Melaminplatte weiß / melamin plate white	20,00
84199 4	53,0 x 16,2	2/4	● Melaminplatte schwarz / melamin plate black	19,00



11629

**Anwendungsbeispiel:**  
mit 17 Stck. Weckgläser  
Ø 6 x 8 cm Nr. 82314

EAN = 40 04 133 XXXX x

# BUFFETSYSTEM „SUPERBOX“

Anwendungs-Beispiel / for example



00991  
Schieferplatte  
GN 1/2



## Superbox GN1/2



Akazienholz / acacia wood / mader de acacia / bois d'acacia

Wendebox: als klassische Buffet-Platten-Box sowie GN-Platten-Buffetbox einsetzbar  
reversible box - can be used as a normal box or to build up different buffet sceneries

caja girable - se puede utilizar como una caja o para construir diferentes paisajes de bufé

boîte de tournage - se peut utilisée comme une boîte ou pour construire des paysages de buffet

	cm	cm		€
11621 4	35 x 29	10,5	● hellbraun / light brown	18,00
11627 6	35 x 29	10,5	● schwarz / black	18,00

## passendes Zubehör / suitable accessories / accesorios a juego / accessoires assortis

	cm	GN		€
00991 2	32,5 x 26,5	1/2	Schieferplatte / slate tray	8,40
84186 4	32,5 x 26,5	1/2	○ Melaminplatte weiß / melamin plate white	18,20
84196 3	32,5 x 26,5	1/2	● Melaminplatte schwarz / melamin plate black	18,20



**NEW**

### Superbox GN1/4



Akazienholz / acacia wood / madera de acacia / bois d'acacia

Wendebox: als klassische Buffet-Box sowie GN-Platten-Buffetbox einsetzbar  
reversible box - can be used as a normal box or to build up different buffet sceneries  
caja girable - se puede utilizar como una caja o para construir diferentes paisajes de bufé  
boîte de tournage - se peut utilisée comme une boîte ou pour construire des paysages de buffet



11622

	cm	↑ cm		€
11622 1	29,0 x 18,5	10,5	●	hellbraun / light brown 15,00
11628 3	29,0 x 18,5	10,5	●	schwarz / black 15,00



82316  
Weck-Glas

11622  
Box  
GN1/2

### passendes Zubehör / suitable accessories / accesorios a juego / accessoires assortis

	cm	GN		€
00993 6	26,5 x 16,2	1/4		Schieferplatte / slate tray 4,60
84188 8	26,5 x 16,2	1/4	○	Melaminplatte weiß / melamin plate white 10,40
84198 7	26,5 x 16,2	1/4	●	Melaminplatte schwarz / melamin plate black 10,40

# BRIDGE designed by CULTURE FORM



## Der „Alleskönner“ für Ihr Buffet!

Mit hohem Anspruch an Design und Funktionalität haben wir das Buffet-System „Bridge“ für Sie entwickelt. Die perfekt aufeinander abgestimmten Komponenten unterstützen die Präsentation Ihrer Speisen und ermöglichen Ihnen den unkomplizierten Aufbau Ihrer einzigartigen Buffet-Landschaften. Die in den Holzoberflächen Ahorn und Wenge erhältlichen Artikel sind in ihren Höhen und ihren Volumina optimal aufeinander abgestimmt und gewährleisten einen einfachen und sicheren Umgang in Ihrem Gastronomiealltag.

The collection "Bridge" is bringing perfectly coordinated components for an uncomplicated and organized buffet system, finalizing in an unique buffet scenery. All pieces combine perfectly with one another in their variations of sizes and volumes. The wooden items are available in 2 colors, maple or wenge. A simple and safe handling is guaranteed.

Una colección universal para un buffé único: un sistema funcional y fácil de componer, asociado a la elegancia de su exclusivo diseño. Los elementos se combinan a la perfección entre variaciones de alturas y volúmenes, realizando sus propuestas y composiciones culinarias y modelando el paisaje del buffé. Las piezas están disponibles en 2 colores, wengué o arce. Manejo sencillo y seguro.

Une collection universelle pour une présentation unique de votre buffet: fonctionnel et facile à composer, ce système est à la fois pratique, simple et spectaculaire par son élégant design. Les différents éléments se marient à la perfection pour construire sans difficulté différentes compositions, variant les hauteurs et les volumes et mettant en valeur vos créations culinaires. Vous pouvez modeler vous-même votre buffet comme un paysage. Les pièces sont disponibles en deux couleurs, bois wengué ou érable. Manipulation aisée et sûre.



13990  
Ahorn



14990  
Wenge

### Kühlbox „BRIDGE“ refrigerated buffet display set de bufé refrigerado présentoir buffet froid



Set bestehend aus: 1 Gestell aus Ahorn oder Wenge, 1 Behälter aus Kunststoff, 1 GN1/1 Tablett aus Melamin, 1 Kühlakku, 1 Rolltophaube (fix montiert)

set consists of: 1 base element maple or wenge, 1 plastic insert black, 1 GN1/1 tray melamine, 1 cooler, 1 cover (fixed)

incluye: soporte de madera en arce o wengué, 1 cubeta de plástico, 1 bandeja de melamina GN1/1, 1 placa de frío GN 1/1, 1 campana rolltop (fija)

support bois en érable ou wengué, 1 bac plastique, 1 plat mélamine GN 1/1, 1 plaque de froid GN1/1, 1 cloche rolltop (fixe)

	□ cm	↑ cm		€
13990 9	63,5 x 42,5	31	Ahorn	334,00
14990 8	63,5 x 42,5	31	Wenge	334,00

**Tablets und Behälter bis  
100mm einsetzbar  
GN1/1, GN1/2, GN1/3**



**Kühlschale „BRIDGE“  
cooling bowl  
bol refrigerado  
bol réfrigéré**



Set bestehend aus: 1 Gestell aus Ahorn oder Wenge, 1 Behälter aus Edelstahl, 1 Schale aus Melamin (Ø 14 cm o. Ø 23 cm), 1 Kühlakku

set consists of: 1 base element maple or wenge, 1 bowl stainless, 1 bowl melamine (Ø 14 cm o. Ø 23 cm), 1 cooler

	□ cm	↑ cm	ltr.			€
13980 0	18,5 x 18,5	10	0,50	Ahorn	●	51,50
13981 7	27,5 x 27,5	14	2,50	Ahorn	●	102,00
14980 9	18,5 x 18,5	10	0,50	Wenge	●	51,50
14981 6	27,5 x 27,5	14	2,50	Wenge	●	102,00

passender Deckel:  
10890 Ø 14 cm  
10887 Ø 23 cm



Buffet. Banquet  
buffet. banquet



**Einzelteile / spare parts / piezas sueltas / pièces détachées**

Edelstahlschale / bowl / bol / bol

	□ cm	↑ cm		€
30050 7	Ø 14	8,5		23,00
30052 1	Ø 23	13,5		51,50



Melaminschale / bowl / bol / bol

	□ cm	↑ cm	ltr.		€
83700 3	Ø 14	6,5	0,50	○	3,80
83701 0	Ø 14	6,5	0,50	●	3,80
83702 7	Ø 23	10,5	2,50	○	9,00
83703 4	Ø 23	10,5	2,50	●	9,00



Deckel / cover / tapa / couvercle

	□ cm		€
10890 5	Ø 14		10,50
10887 5	Ø 23		19,00



Kühlakku / cooler / acumulador de frío / accumulateur de froid

	□ cm	↑ cm	€
10781 6	Ø 10,5	2,5	3,00
10777 9	Ø 15	2,5	5,00

designed by **CULTURE FORM**

**Cerealienspender „BRIDGE“**  
**cereal dispenser**  
**dispensador de cereales**  
**distributeur de céréales**



Behälter herausnehmbar, „Feierabend-Deckel“ für das aromadichte Lagern, portionieren durch einfaches Drehen

removable canister, special lid to keep the cereals fresh, easy to use, rotate the button to get the muesli

contenedor movable, tapa especial para mantener los cereales frescos, fácil de usar, se gira el pomo para servir los cereales

réceptif amovible, couvercle spécial pour conserver les céréales, usage facile en tournant le bouton



13987  
Ahorn

14987  
Wenge

	□ cm	↑ cm	ltr.			€
13987 9	21 x 20	55,5	4,5	Ahorn	●	102,00
14987 8	21 x 20	55,5	4,5	Wenge	●	102,00

designed by **CULTURE FORM**

**Saftdispenser „BRIDGE“**  
**juice dispenser**  
**dispensador de zumo**  
**distributeur à jus de fruit**



Kühlung durch 2 Kühlakkus von oben und unten

cooling with 2 cooling elements from the top and base

2 acum. de frío 1 en la base y 1 en la tapa

2 plaques de froid 1 dans le couvercle, 1 dans le socle



10873  
Wenge

10870  
Ahorn

	□ cm	↑ cm	ltr.			€
10870 7	31,0 x 20,0	42	4	Ahorn	●	224,00
10871 4	35,5 x 22,0	50	6	Ahorn	●	264,00
10872 1	31,0 x 20,0	42	4	Wenge	●	224,00
10873 8	35,5 x 22,0	50	6	Wenge	●	264,00



inkl. 3 Magnetschilder:  
 „ORANGE“  
 „APPLE“  
 „GRAPEFRUIT“

designed by **CULTURE FORM**

**Besteckbehälter „BRIDGE“**  
**cutlery organizer**  
**cajón para cubiertos**  
**bac à couverts**



2 teiliges Set: 1 Gestell aus Ahorn oder Wenge, 1 Besteckbehälter (Nr. 11955), herausnehmbar  
 2 pcs set: 1 base element maple or wenge, 1 removable plastic container (item 11955)  
 set de 2 piezas: soporte madera arce o wengué + 1 cubeta extraíble 4 compartimentos de plástico (ref. 11955)  
 set de 2 pcs: support bois en érable ou wengué + 1 bac plastique amovible à 4 compartiments (réf. 11955)

	□ cm	↑ cm			€
13995 4	57,5 x 47,0	12	Ahorn	●	78,00
14995 3	57,5 x 47,0	12	Wenge	●	78,00

designed by **CULTURE FORM**

**Konferenzkühler „BRIDGE“**  
**bottle cooler**  
**enfriador**  
**refraîchisseur**



13985  
Ahorn

2-teiliges Set, bestehend aus: 1 Gestell aus Ahorn oder Wenge, 1 Behälter aus Edelstahl (doppelwandig)  
 2 pcs set: 1 base element maple or wenge, 1 bowl stainless steel (double-wall)  
 set de 2 piezas: soporte madera arce o wengué, champañera inox de doble pared  
 set de 2 pcs: support bois en érable ou wengué, seau inox double paroi

	□ cm	↑ cm			€
13985 5	35 x 35	19	Ahorn	●	154,00
14985 4	35 x 35	19	Wenge	●	154,00



14985  
Wenge

designed by **CULTURE FORM**

**Flaschenkühler „BRIDGE“**  
**bottle cooler**  
**champañera de bufé**  
**seau à champagne**

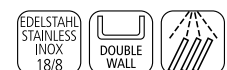

10 ltr.

doppelwandig für beste Isolierung, außen poliert, innen mattiert  
 double wall cooler keeps the temperature for a long time, outside mirror polished, inside matt finish  
 champañera inox de doble pared, interior mate, exterior brillante  
 seau inox double paroi, maintient le froid plus longtemps, intérieur mat, extérieur poli brillant

	□ cm	↑ cm	ltr.	€
36077 8	Ø 31	19	10	98,00

# DESIGN IM DETAIL

Die reduzierte, archetypische Formsprache von FRAMES nimmt sich elegant zurück und lässt damit viel Raum für die Inszenierung der Buffet-Speisen. Ein scheinbarer Widerspruch löst sich auf: das Design ist zeitgemäß und zeitlos zugleich.

Design in detail – The classic minimalist visual style of FRAMES is elegantly understated, leaving plenty of potential for creating appealing buffet arrangements. Its design transcends what at first seems to be an irreconcilable paradox, being at once both timeless and highly contemporary.





„Neben formalen Aspekten ist eine sensible Auswahl von Materialien entscheidend, um ein erfolgreiches Design zu entwickeln.“

Michael Sieger / sieger design



designed by sieger design

**Bildschön** sind die Edelstahlplatten von FRAMES, die den Speisen des Buffets einen würdigen Rahmen verleihen sollen. **The attractive** FRAMES stainless steel platters provide buffet food with a setting that truly does it justice.



Das neue Buffetsystem, entwickelt von sieger design –

Funktionalität  
Universalität  
Stil

## FRAMES

Die Grundidee von FRAMES ist einfach: köstlichen Speisen einen attraktiven Rahmen geben. Und das ist durchaus wörtlich zu verstehen. Wie hochwertige Rahmungen eines Bildes sind die Edelstahlplatten des Buffetsystems gestaltet. Gleichzeitig erfüllt FRAMES sämtliche Anforderungen des modernen gastronomischen Alltags. Die Funktionalität der Produkte war bei der Design-Entwicklung ein zentraler Gedanke.

The basic idea behind FRAMES is a simple one: framing delicious food in an attractive setting. It's a concept we've taken literally to create the stainless steel platters in our new buffet range, platters which work in the same way as high-quality picture frames. At the same time, FRAMES meets all the requirements of contemporary kitchens. Indeed, functionality was a core consideration throughout the design and development stages.

# COOL PLATES

## Sets

EDELSTAHL 18/10  
stainless steel



12940 **224,- €**



12941 **286,- €**



12942 **229,- €**

WENGE  
wenge



14940 **226,- €**



14941 **289,- €**



14942 **232,- €**

AHORN  
maple



13940 **226,- €**



13941 **289,- €**



13942 **232,- €**

**SET 1**  
53 x 32,5 x 8,5 cm

GN 1/1 Basiselement  
GN 1/1 Edelstahl Tablett 18/10  
Kühlakku  
*GN 1/1 base element  
GN 1/1 stainless steel platter 18/10  
cooler*

**SET 2**  
53 x 32,5 x 27,5 cm

GN 1/1 Basiselement  
GN 1/1 Edelstahl Tablett 18/10  
Rolltop-Haube, Kühlakku  
*GN 1/1 base element  
GN 1/1 stainless steel platter 18/10  
rolltop cover, cooler*

**SET 3**  
53 x 32,5 x 8,5 cm

GN 1/1 Basiselement  
2 x GN 1/2 Edelstahl Tablett 18/10  
Kühlakku  
*GN 1/1 base element  
2 x GN 1/2 stainless steel platters 18/10  
cooler*

## Chop Modules



13955 **51,50 €**



13960 **55,60 €**



17910 **54,- €**

**CHOPPING BOARD 1**

Ahorn, massiv  
*solid maple*

GN 1/1

**CHOPPING BOARD 2**

Ahorn, massiv, gerillt  
*solid maple*

GN 1/1

**CHOPPING BOARD 3**

Polyethylen, schwarz  
*Polyethylene, black*

GN 1/1

# COOL PLATES

## Bowl Modules

WENGE  
wenge



14950 **66,- €**



14951 **82,- €**



14952 **128,- €**

AHORN  
maple



13950 **66,- €**



13951 **82,- €**



13952 **128,- €**

### BOWL MODULE

GN 1/1 Schüsselhalter einzeln  
mit 5 Löchern, ø 13,2 cm  
*GN 1/1 bowl module, each with  
five holes, ø 13,2 cm*

### BOWL MODULE SET 1

GN 1/1 Schüsselhalter Set  
mit 5 weißen Melaminschüsseln  
*GN 1/1 bowl module set with 5 white  
melamine resin bowls*

### BOWL MODULE SET 2

GN 1/1 Schüsselhalter Set mit  
5 weißen Melaminschüsseln und  
5 Deckeln  
*GN 1/1 bowl module set with 5 white  
melamine resin bowls and 5 lids*

## Components

### TRAYS

GN 1/1 Edelstahl Tablett 18/10  
*GN 1/1 stainless steel platter  
18/10*



11119 **28,- €**

GN 1/2 Edelstahl Tablett 18/10  
*GN 1/2 stainless steel platter  
18/10*

11118 **16,- €**

Kühlakku cooler



10782 **14,20 €**

Polystyrolwanne GN 1/1, schwarz  
*polystyrene tray GN 1/1, black*

17922 **55,20 €**

### COVER

GN 1/1 Rolltop-Haube  
*rolltop cover*

Rolltop-Haube  
für Basket Round  
*rolltop cover*



11018 **62,- €**

Bowl L Deckel ø 23 cm lid  
Bowl S Deckel ø 14,5 cm lid  
– mit Dichtungsring für  
luftdichtes Verschießen  
– 2 fixierbare Öffnungs-  
positionen einstellbar



10887 **19,00 €**

10890 **10,50 €**



18389 **21,- €**

### BOWLS

Melaminschüssel weiß  
*melamine resin bowl white*

ø 14 cm, Höhe 6,5 ..... 83700 **3,80 €**  
ø 23 cm, Höhe 10 ..... 83702 **9,00 €**

Melaminschüssel schwarz  
*melamine resin bowl black*

ø 14 cm, Höhe 6,5 ..... 83701 **3,80 €**  
ø 23 cm, Höhe 10 ..... 83703 **9,00 €**

Edelstahlschüssel  
*stainless steel bowl*

ø 14 cm, Höhe 6,5 ..... 30040 **17,80 €**  
ø 23 cm, Höhe 10 ..... 30042 **29,00 €**

Glasschüssel

*glass bowl*  
ø 14 cm, Höhe 6,5 ..... 11865 **2,20 €**  
ø 23 cm, Höhe 10 ..... 11875 **4,20 €**



# BOWL BOARDS

WENGE  
wenge



14935 **254,- €**

14936 **304,- €**

14930 **179,- €**



14931 **205,- €**

AHORN  
maple



13935 **254,- €**

13936 **304,- €**

13930 **179,- €**



13931 **205,- €**



**Polystyrolwanne L** schwarz  
polystyrene tray L, black

17921 **48,50 €**

**Polystyrolwanne S** schwarz  
polystyrene tray S, black

17920 **37,50 €**

## BOWL BOARD L

**SET 1** 6-teilig 6 pcs.

Basiselement, Kunststoffwanne, Abdeckplatte für 3 Schüsseln (ø 23 cm), 3 Melaminschüsseln, weiß (79,5 x 26,5 x 8,5 cm)  
base element, polystyrene tray L, cover panel to hold 3 bowls (ø 23 cm), 3 melamine resin bowls, white (79,5 x 26,5 x 8,5 cm)

## BOWL BOARD L

**SET 2** 9-teilig 9 pcs.

Basiselement, Kunststoffwanne, Abdeckplatte für 3 Schüsseln (ø 23 cm), 3 Melaminschüsseln, weiß, mit Deckeln (79,5 x 26,5 x 8,5 cm)  
base element, polystyrene tray L, cover panel to hold 3 bowls (ø 23 cm), 3 melamine resin bowls white, with lids (79,5 x 26,5 x 8,5 cm)

## BOWL BOARD S

**SET 1** 6-teilig 6 pcs.

Basiselement, Kunststoffwanne, Abdeckplatte für 3 Schüsseln, Melaminschüsseln (ø 14 cm), weiß (53 x 17,6 x 8,5 cm)  
base element, polystyrene tray S, cover panel to hold 3 bowls (ø 14 cm), 3 melamine resin bowls, white (53 x 17,6 x 8,5 cm)

## BOWL BOARD S

**SET 2** 9-teilig 9 pcs.

Basiselement, Kunststoffwanne, Abdeckplatte für 3 Schüsseln (ø 14 cm), Melaminschüsseln, weiß, mit Deckeln (53 x 17,6 x 8,5 cm)  
base element, polystyrene tray S, cover panel to hold 3 bowls (ø 14 cm), 3 melamine resin bowls, white, with lids (53 x 17,6 x 8,5 cm)

# BOWL STANDS



11398 **257,- €**



11399 **205,- €**



11395 **80,30 €**



11396 **10,30 €**

11397 **20,60 €**

## SET 1

Buffetleiter für 5 Schüsseln (ø 23 cm), Melaminschüsseln, weiß, mit Deckeln  
bowl stand for 5 bowls (ø 23 cm), melamine resin bowls, white, with lids

## SET 2

Buffetleiter für 7 Schüsseln (ø 23 cm), Melaminschüsseln, weiß  
bowl stand for 7 bowls (ø 23 cm), melamine resin bowls, white

## Components

Leiter ladder ..... 11395  
Ring einzeln single ..... 11396  
Ring doppelt double ..... 11397

## BOWL BOXES



12925 **100,- €**



12920 **51,- €**



12915 **99,- €**



12911 **57,- €**

**EDELSTAHL 18/10**  
stainless steel



14925 **112,- €**



14920 **62,- €**



14915 **112,- €**



14911 **69,- €**

**WENGE**  
wenge



13925 **112,- €**



13920 **62,- €**



13915 **112,- €**



13911 **69,- €**

**AHORN**  
maple

**BOWL BOX L**  
eckig *square*

Isolierendes Basiselement (26,5 x 26,5 cm, Höhe 8,5 cm) mit Melaminschüsseln, weiß, mit oder ohne Deckel  
*Insulating base element (26,5 x 26,5 cm, height 8,5 cm) with melamine resin bowls, white, lid optional*

**BOWL BOX S**  
eckig *square*

Isolierendes Basiselement (17,4 x 17,4 cm, Höhe 6 cm) mit Melaminschüsseln, weiß, mit oder ohne Deckel  
*Insulating base element (17,4 x 17,4 cm, height 6 cm) with melamine resin bowls, white, lid optional*

**BOWL BOX L**  
rund *round*

Isolierendes Basiselement (ø 26,5 cm, Höhe 8,5 cm) mit Melaminschüssel, weiß, mit oder ohne Deckel  
*Insulating base element (ø 26,5 cm, height 8,5 cm) with melamine resin bowl, white, lid optional*

**BOWL BOX S**  
rund *round*

Isolierendes Basiselement (ø 17,4 cm, Höhe 6 cm) mit Melaminschüssel, weiß, mit oder ohne Deckel  
*Insulating base element (ø 17,4 cm, height 6 cm) with melamine resin bowl, white, lid optional*

## BASKETS



40293 **23,- €**

GN 1/1

40291 **18,50 €**



40292 **13,80 €**

GN 1/2

40290 **11,50 €**



40295 **19,80 €**



40294 **28,70 €**

**BASKET L**

Polyrattan, dunkelbraun  
*Polyrattan, dark brown*

GN 1/1, 53 x 32,5 x 10 cm  
GN 1/1, 53 x 32,5 x 6,5 cm

56,5 x 36 x 10 cm  
mit Haubenschiene  
(ohne Haube 11018)  
*with frame to fix the cover  
(without cover 11018)*

**BASKET S**

Polyrattan, dunkelbraun  
*Polyrattan, dark brown*

GN 1/2, 32,5 x 26,5 x 10 cm  
GN 1/2, 32,5 x 26,5 x 6,5 cm

**BASKET ROUND**

Polyrattan, dunkelbraun,  
*Polyrattan, dark brown*

ø 40 cm, Höhe *height* 12,5 cm  
mit Haubenschiene  
(ohne Haube 18389)  
*with frame to fix the cover  
(without cover 18389)*

designed by **sieger design**

GN1/1 - 1/2 - 1/3



**Tablett „FRAMES“**  
tray  
bandeja  
plateau



	cm	↑ cm	GN	€
84046 1	53,0 x 32,5	2	1/1	26,00
84047 8	32,5 x 26,5	2	1/2	14,20
84048 5	32,5 x 17,6	2	1/3	10,00

2-teilig / 2 pcs.



14956



14954

**Besteck- / Universal-Box, 2-teilig „FRAMES“**  
cutlery tray, 2 pcs.  
cuberto o cajón multi-usos, 2pz.  
caisson à couverts ou multi-usages



Buche massiv, Wenge, 4 Fächer, inklusive herausnehmbaren Einsatz  
wood wenge, 4 compartments  
madera de haya maciza, color wengué, 4 compartimentos, separadores removibles  
hêtre massif, couleur wengé, 4 compartiments, séparateurs amovibles

	cm	↑ cm	€
14956 4	53 x 32,5	11	174,00

**Einzelteile / spare parts / piezas sueltas / pièces détachées**

Einsatz für GN1/1 „FRAMES“ / insert for GN1/1 „FRAMES“  
interior para GN1/1 „FRAMES“ / insert pour GN1/1 „FRAMES“

14954 0	48,5 x 28	8	40,00
---------	-----------	---	-------



**Eisbox „FRAMES“**  
ice box  
bandeja hielo para el bufé  
caisse à glaçons pour le buffet



3-teilig: 1 Basiselement Wenge + 1 Polystyrolwanne + 1 Tropfgitter  
3 pcs. set: 1 box wenge + 1 plastic deep tray + 1 drainer plate  
set 3 piezas : 1 cajón color wengué, 1 cubeta plástico, 1 rejilla  
set 3 éléments: caisson couleur wengé, 1 bac plastique, 1 plaque perforée

	cm	↑ cm	GN	€
14970 0	53 x 32,5	12,5	1/1	179,00

**Gestell für GN1/1 „FRAMES“**  
serving stand  
cuberto o cajón multi-usos  
caisson à couverts ou multi-usages



Buche massiv, Wenge  
wood, wenge  
madera de haya maciza, wengué  
hêtre massif, wengé



vielseitig  
einsetzbar für alle  
GN1/1 Artikel

	cm	↑ cm	€
14953 3	57,5 x 27,5	22	76,00



84047  
GN1/2

84047  
GN1/2

14942  
passendes GN1/1  
Basiselement

12941  
Cool Plate +  
Haube



14953  
Gestell GN1/1



14956  
Besteck / Universal-Box  
GN1/1



13966

**Buffetgestell „TRIANGLE“**  
buffet stand  
expositor de bufé  
présentoir à céréales



	□ cm	↑ cm			€
13966 4	53 x 21	50	●	Ahorn / maple	136,00
14966 3	53 x 21	50	●	Wenge / wenge	136,00



14966



19 x 19 cm

25 x 25 cm

25 x 25 cm

**Buffet-Tower**  
Buffet-Tower  
torre para bufé  
tour carrée pour le buffet

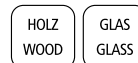

3-stufig, Glas in Spiegeloptik, Holz Birke dunkelbraun, Lieferung demontiert  
with beech wood pillar, tempered glass mirror surface, each in knock-down packing  
3 pisos, vidrio templado, eje central de madera oscura, se entrega desmontado  
3 étages, verre trempé, axe central carré en bois foncé, livré non-monté

	□ cm	↑ cm		€
12415 8	25 x 25	30,5		55,00



**High Tea Rack**  
High Tea Rack  
rack de te alto  
étagère à thé avec anse supérieure



Holz dunkelbraun, Edelstahlgriff, 4 große Fächer 15 x 10 x 10 cm,  
3 kleine Fächer 9,5 x 9,5 x 10 cm  
rubber wood in dark brown, stainless handle, 4 big compartments 15 x 10 x 10 cm,  
3 small compartments 9,5 x 9,5 x 10 cm  
madera marrón oscura, mango de acero inoxidable, 4 compartimentos grandes 15 x 10 x 10  
cm, 3 compartimentos pequeños 9,5 x 9,5 x 10 cm  
bois marron foncé, poignée inox, 4 compartiment grand 15 x 10 x 10 cm, 3 compartiment petit  
9,5 x 9,5 x 10 cm

	□ cm	↑ cm		€
33210 2	34 x 10	38		33,00

# BUFFET-STÄNDER designed by CULTURE FORM



**Buffet-Ständer „STAR“**  
**buffet stand**  
**soporte para bufé**  
**présentoire buffet**



Metall, mit schwarzer Antirutschgummierung  
 metal, with black anti-slide coating  
 acero cromado, con recubrimiento negro antideslizante  
 metal avec revêtement plastique noir antiglisse

	↑ cm	€
33260 7	8	14,00
33261 4	12	16,50
33262 1	18	18,90





**NEW**



33269



33270



33271

**Buffet-Ständer „MULTI ROUND“**  
buffet stand  
soporte para bufé  
présentoir buffet



Metall, mit schwarzer Antirutschgummierung  
metal, with black anti-slide coating  
acero, con recubrimiento negro antideslizante  
metal, revêtement plastique noir anti-glisse

	□ cm	↑ cm	€
33269 0	Ø 15,5 / 18	8	10,00
33270 6	Ø 15,5 / 18	10	12,00
33271 3	Ø 15,5 / 18	18	15,00



für jede Art von  
Platten, Tablett und  
Schalen geeignet

Buffet . Banquet  
buffet . banquet



33250



33251

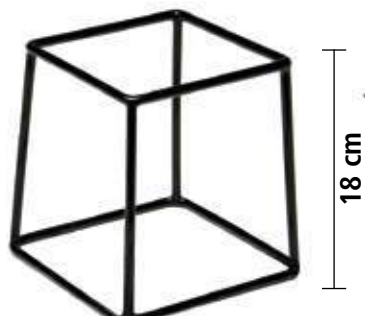

33252

**Buffet-Ständer „MULTI“**  
buffet stand  
soporte para bufé  
présentoir buffet



Metall, mit schwarzer Antirutschgummierung ummantelt  
metal, with black anti-slide coating  
acero cromado, con recubrimiento negro antideslizante  
metal avec revêtement plastique noir antiglisse

	□ cm	↑ cm	€
33250 8	18 x 18	8	12,40
33251 5	18 x 18	10	15,00
33252 2	18 x 18	18	17,50



für jede Art von  
Platten, Tablett und  
Schalen geeignet

**NEW**



**Buffet-Ständer „PRISMA“**  
buffet stand  
soporte para bufé  
présentoir buffet



Metall, mit schwarzer Antirutschgummierung  
metal, with black anti-slide coating  
acero, con recubrimiento negro antideslizante  
metal, revêtement plastique noir antiglisse

	☐ cm	↑ cm		€
33272 0	26	10,5		9,00
33273 7	26	20		13,00

**NEW**



**Buffet-Ständer „DIAMOND“**  
buffet stand  
soporte para bufé  
présentoire buffet



Metall, mit Antirutschgummierung  
metal, with anti-sliding coating  
acero, con recubrimiento antideslizante  
metal, revêtement plastique antiglisse

	☐ cm	↑ cm		€
33274 4	Ø 20 /25	10	● gold	12,00
33275 1	Ø 20 /25	19,5	● gold	14,00
33276 8	Ø 20 /25	10	● kupfer / copper	12,00
33277 5	Ø 20 /25	19,5	● kupfer / copper	14,00

**NEW**



**Buffet-Ständer „WOOD“**  
buffet stand  
soporte para bufé  
présentoire buffet



liegend oder stehend, variable Ausführungsmöglichkeiten  
usable by lying or standing, there are different possibilities to be chosen  
se puede usar tumbado o de pie, hay diferentes opciones de utilizar  
il y a différentes possibilités d'usage

	☐ cm	↑ cm		€
33280 5	20 x 20	17,5	●	9,00
33281 2	20 x 20	17,5	●	9,00



liegend oder stehend -  
variable  
Ausführungsmöglichkeiten

designed by sieger design

**NEW**

**Buffetständer „ASIA PLUS“**  
**buffet stand**  
**soporte para bufé**  
**présentoir buffet**



	□ cm	↑ cm		€
15513 8	Ø 20,5 / 16,5	20	poliert / polished / mate / poli	15,00
15514 5	Ø 20,5 / 16,5	20	● black coated	14,00



**optimaler Sitz der Schale im Buffetständer**

designed by **CULTURE FORM**

**Buffet-Ständer „KING“**  
**buffet stand**  
**soporte para bufé**  
**présentoir buffet**



kein Verrutschen, Arme und Boden sind mit Antirutschflächen ausgestattet, schwere standsichere Qualität, Fuß dient als Löffelablage

the arms and base are equipped with non-slip surfaces, stable quality, base serves as spoon holder

anti-deslizante: revestimiento antideslizante en las puntas de los brazos y en la base, estable y alta calidad, la base sirve como reposacuchara

antiglisse: revêtement antidérapant sur les extrémités des 3 pieds et sur la base, robuste, stable et bonne qualité, la base sert de support pour les couverts

	□ cm	↑ cm	€
03622 2	Ø 15	14	36,00
03623 9	Ø 15	21	39,60



Löffelablage  
 spoon holder



stapelbar  
 stackable  
 apilables  
 empilable



rutschfeste Oberfläche  
 non-slip surface  
 superficie antideslizante  
 superficie antiglisse



33232  
Gestell



40240  
Korb

40144  
Körbe



platzsparend  
zusammenklappbar



ausklappbar

### Buffet-Gestell buffet stand soporte para bufé présentoir buffet



3-stufig, geeignet für runde und rechteckige Körbe, platzsparend zusammenklappbar, Lieferung ohne Körbe

3-tier, usable for round and rectangular baskets, can be bushed together for place saving, delivery without baskets

3 alturas, apto para cestas redondas y rectangulares, se puede plegar para ahorrar espacio, se entrega sin cestas

3 hauteurs, pour corbeilles rondes ou rectang, la structure s'ouvre ou se ferme pour réduire l'encombrement, livré sans corbeilles

	□ cm	↑ cm	€
33232 4	59 x 30,5	59	18,50

### Einzelteile / spare parts / piezas sueltas / pièces détachées

Tisch- und Buffetkorb, rund „ECONOMIC“ / buffet basket, round  
cesta de bufé redonda / corbeille de buffet ronde

40144 0	Ø 39,0	10,0	●	natur / nature	13,80
---------	--------	------	---	----------------	-------

Korb „GN LINE“ / basket GN  
cesta GN / corbeille GN

40240 9	53 x 32,5	10	●	natur / nature	21,90
40270 6	53 x 32,5	10	●	braun / brown	21,90



03617  
3-teiliges Set



03621  
3-teiliges Set

### Stufen-Display tier display expositor en escalera présentoir en escalier



mit Schieferstruktur

with slate structure

con relieve tipo pizarra

avec relief irrégulier type ardoise

	□ cm	↑ cm	€
03614 7	40 x 18	4	20,00
03615 4	40 x 20	8	24,80
03616 1	40 x 22	12	27,80
03618 5	20 x 18	4	12,00
03619 2	20 x 20	8	14,60
03620 8	20 x 22	12	17,40

**3-teiliges Set:** 03614 + 03615 + 03616

**3 pcs. set:** 03614 + 03615 + 03616

**set de 3 piezas:** 03614 + 03615 + 03616

**set 3 pièces:** 03614 + 03615 + 03616

03617 8			71,50
---------	--	--	-------

**3-teiliges Set:** 03618 + 03619 + 03620

**3 pcs. set:** 03618 + 03619 + 03620

**set de 3 piezas:** 03618 + 03619 + 03620

**set 3 pièces:** 03618 + 03619 + 03620

03621 5			42,40
---------	--	--	-------

**NEW**



**3-stufige Etagère**  
**3-tier tray**  
**bandeja con tres alturas**  
**étagère carré 3 hauteurs**



rutschfeste, möbelschonende Füßchen, Naturschiefer, Akazienholz  
 non-slip feet, natural slate tray, wood akazie  
 pies antideslizantes, bandeja de pizarra natural, madera  
 pieds antidérapants, plateau ardoise naturelle, bois

	☐ cm	↑ cm	✱ mm	€
00960 8	Ø 30 / 25 / 20	34	4 - 7	26,00



24336  
5-teilig

**Etagère „ROYAL“**  
**etagère**  
**expositor**  
**présentoir**



5-teilig: 3 Edelstahl-Schalen + 2 Gestelle, einfach übereinanderstellen, einzeln nutzbar  
 5 pcs. set: 3 bowls + 2 frames, easy to assemble, single usable  
 set de 5 piezas: 3 bols + 2 soportes, fácil de montar  
 5 éléments: 3 bols + 2 supports, montage facile

	☐ cm	↑ cm	€
24336 1	Ø 24 / 33 / 42	43,5	157,00



24335  
24334  
3-teilig

3-teilig: 2 Edelstahl-Schalen + 1 Gestell, einfach übereinanderstellen, einzeln nutzbar  
 3 pcs. set: 2 bowls + 1 frame, easy to assemble, single usable  
 set de 3 piezas: 2 bols + 1 soporte, fácil de montar  
 3 éléments: 2 bols + 1 support, montage facile

24335 4	Ø 33 / 42	25	106,00
24334 7	Ø 24 / 33	22	67,00



24330  
24331  
24332

**Einzelteile / spare parts / piezas sueltas / pièces détachées**

Schale, innen hochglanzpoliert, außen matt poliert  
 bowl, mirror polished finish inside, satin polished finish outside  
 fuente, pulido espejo en el interior, exterior mate  
 plateau intérieur effet brillant, extérieur mat

	☐ cm	↑ cm	ltr.	€
24330 9	Ø 24	3	0,6	23,80
24331 6	Ø 33	4	1,3	37,00
24332 3	Ø 42	5	2,5	57,00

Gestell einzeln / stand alone / pie soporte / pied seul

24338 5	Ø 18	19	9,90
24339 2	Ø 24	20	14,00



33240  
LARGE



33235  
MEDIUM

**Etagère „FRUITS BUFFET“**  
etagère  
frutero  
présentoir à fruits



hochglanzpoliert, Edelstahl-Schale herausnehmbar  
mirror polished finish, bowl removable  
acabado brillante, bandeja inferior suelta  
effet brillant, bol inférieur amovible

	☐ cm	↑ cm	€
33235 5	Ø 27,5	32	60,00
33240 9	Ø 32	53	94,00

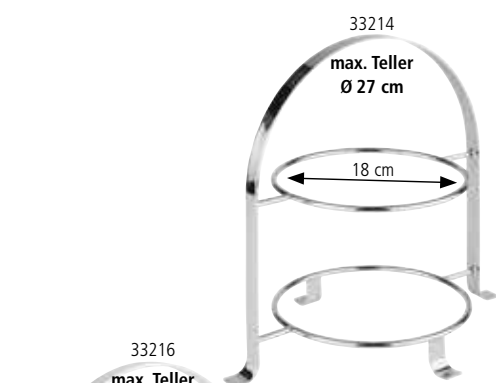

33214  
max. Teller  
Ø 27 cm

18 cm



33216  
max. Teller  
Ø 17 cm



33217  
max. Teller  
Ø 27 cm

**Serviergestell Metallprofil flach**  
serving stand flat profile  
soporte con perfil acero cromado plano  
présentoir, profil métal plat



für 2 Teller max. Ø 27 cm, innerer Ring Ø 18 cm, Lieferung ohne Teller  
for 2 plates max. Ø 27 cm, circle inside Ø 18 cm, without dishes  
para 2 platos Ø 27 cm, interior aro Ø 18 cm, se entrega sin platos  
pour 2 assiettes maxi Ø 27 cm, cercle Ø int. 18 cm, livré sans assiettes

	☐ cm	↑ cm	€
33214 0	33 x 23,5	30	32,00

für 3 Teller max. Ø 17 cm, innerer Ring Ø 10,5 cm  
for 3 plates max. Ø 17 cm, circle inside Ø 10,5 cm  
para 3 platos Ø 17 cm, interior aro Ø 10,5 cm  
pour 3 assiettes maxi Ø 17 cm, cercle Ø int. 10,5 cm

	☐ cm	↑ cm	€
33216 4	22,5 x 16,5	25,5	24,00

für 3 Teller max. Ø 27 cm, innerer Ring Ø 18 cm  
for 3 plates max. Ø 27 cm, circle inside Ø 18 cm  
para 3 platos Ø 27 cm, interior aro Ø 18 cm  
pour 3 assiettes maxi Ø 27 cm, cercle Ø int. 18 cm

	☐ cm	↑ cm	€
33217 1	33 x 24	43	39,00

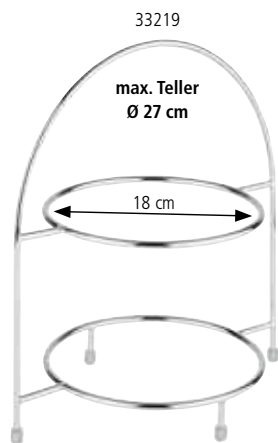

**Serviergestell Metallprofil rund**  
**serving stand wire**  
**soporte platos, alambre metálico**  
**présentoir à assiettes en tube métallique**



für 2 Teller max. Ø 27 cm, innerer Ring Ø 18 cm  
for 2 plates max. Ø 27 cm, circle inside Ø 18 cm  
para 2 platos Ø 27 cm, interior aro Ø 18 cm  
pour 2 assiettes maxi Ø 27 cm, cercle Ø int. 18 cm

	□ cm	↑ cm		€
33219 5	29 x 19,5	30	● chrome	26,20



für 3 Teller max. Ø 17 cm, innerer Ring Ø 10,5 cm  
for 3 plates max. Ø 17 cm, circle inside Ø 10,5 cm  
para 3 platos Ø 17 cm, interior aro Ø 10,5 cm  
pour 3 assiettes maxi Ø 17 cm, cercle Ø int. 10,5 cm

	□ cm	↑ cm		€
33215 7	18,5 x 15,5	26	● chrome	19,40
33211 9	18,5 x 15,5	26	● copper	21,00

für 3 Teller max. Ø 27 cm, innerer Ring Ø 18 cm  
for 3 plates max. Ø 27 cm, circle inside Ø 18 cm  
para 3 platos Ø 27 cm, interior aro Ø 18 cm  
pour 3 assiettes maxi Ø 27 cm, cercle Ø int. 18 cm

	□ cm	↑ cm		€
33220 1	29 x 19,5	43	● chrome	34,00
33212 6	29 x 19,5	43	● copper	36,00

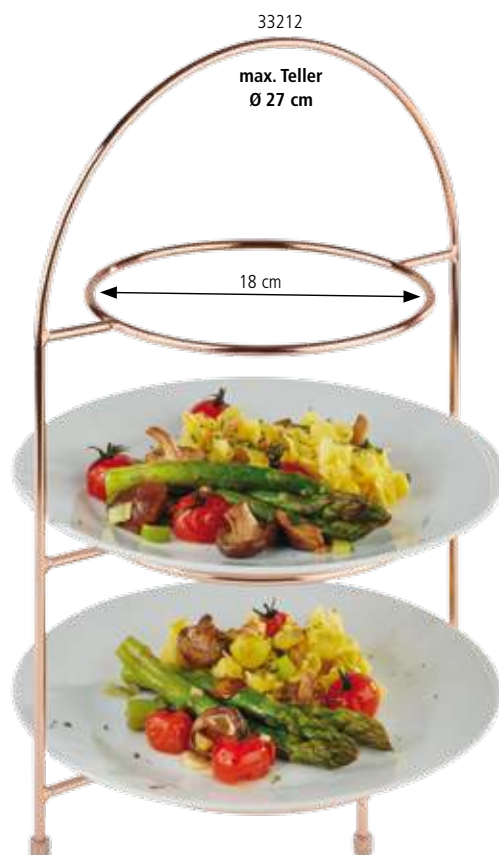

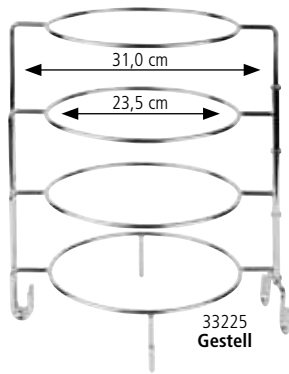

**Serviergestell**  
**serving stand**  
**soporte platos**  
**présentoir à assiettes**



für 4 Teller (max. Ø 31 cm), platzsparend zusammendrehbar, Lieferung ohne Teller  
 for 4 plates (max. Ø 31 cm), can be pushed together for place saving, without dishes  
 para 4 platos (max. Ø 31 cm) se puede plegar para ahorrar espacio, se sirve sin platos  
 pour 4 assiettes (maxi Ø 31 cm), peut se refermer pour réduire l'encombrement, livré sans assiettes

	□ cm	↑ cm	€
33225 6	Ø 34	37	62,00



**viele Möglichkeiten**  
**die Speisen**  
**zu präsentieren**



**Serviergestell**  
**serving stand**  
**expositor**  
**présentoir**



3-stufig für quadratische Teller / Platten in 3 verschiedenen Größen: z.B. 83407 + 83406 + 83405, Lieferung ohne Teller/Platten

3-tier for square dishes / plates in 3 different sizes: e.g. 83407 + 83406 + 83405, delivery without dishes / plates

3 alturas para platos cuadrados fuentes en 3 diferentes medidas p.e. 83407 + 83406 + 83405, se entrega sin platos/ fuentes

3 niveaux pour assiettes ou plats carrés de différentes dimensions, ex. 83407 + 83406 + 83405, livré sans assiettes

	□ cm	↑ cm	€
33231 7	37,5 x 37,5	50	84,00



Tablett quadratisch „PURE“

tray square

bandeja cuadrada

plateau carré

			€
83407 1	21,0 x 21,0	3	9,60
83406 4	26,5 x 26,5	3	14,80
83405 7	37,0 x 37,0	3	19,50

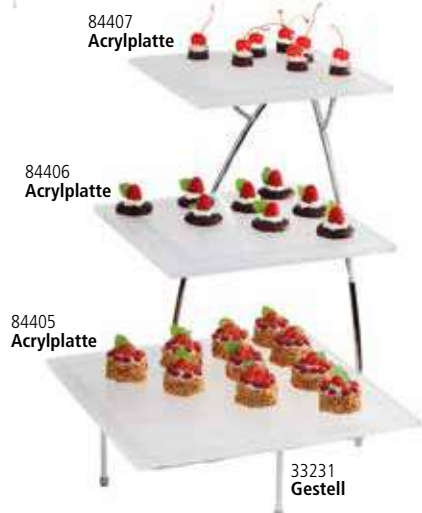

Acrylplatte

plate acryl

bandeja de metacrilato

plateau acrylique

			€
84407 0	23 x 23		19,90
84406 3	30,5 x 30,5		30,90
84405 6	38 x 38		35,00



**Etagère „CASUAL“**  
**etagère**  
**expositor de bombones o bocaditos**  
**présentoir à mignardises**



inkl. Schild  
 incl. sign  
 placa incluida, sin inscripción  
 étiquette incluse, sans inscription



	cm	cm		€
34248 4	Ø 31 - 41 - 51	55	3-stufig / 3-tier 3 niveles / 3 étages	109,00
34247 7	Ø 31 - 41	35	2-stufig / 2-tier 2 niveles / 2 étages	66,00



**einsteckbares**  
**Edelstahlschild, beschriftbar**  
**(Schild ist nicht beschriftet)**



**Etagère „FINESSE“**  
**etagère**  
**frutero**  
**étagère**



vergoldeter Messing-Kugelgriff, einfache Montage  
 gold plated knob, easy to assemble  
 botón dorado, fácil de montar  
 bouton doré, montage facile

	cm	cm		€
33238 6	Ø 38 / 32	30		58,00
33248 5	Ø 48 / 38 / 32	50		95,00



**NEW**

Ø 20 cm

Ø 25 cm

Ø 30 cm



**3-stufige Etagère**  
**3-tier tray**  
**bandeja con tres alturas**  
**étagère carré 3 hauteurs**



rutschfeste, möbelschonende Füßchen, Naturschiefer, Akazienholz  
non-slip feet, natural slate tray, wood akazie  
pies antideslizantes, bandeja de pizarra natural, madera  
pieds antidérapants, plateau ardoise naturelle, bois

	☐ cm	↑ cm	✱ mm	€
00960 8	Ø 30 / 25 / 20	34	4 - 7	26,00

**2-stufige Etagère**  
**2 tier tray**  
**bandeja dos alturas**  
**plat carré 2 hauteurs**



rutschfeste, möbelschonende Füßchen, Naturschiefer  
non-slip feet, natural slate tray  
pies antideslizantes, bandeja de pizarra natural  
pieds antidérapants, plateau ardoise naturelle

	☐ cm	↑ cm	✱ mm	€
00989 9	Ø 25 / 20	24	4 - 7	13,20



**Etagère**  
**etagère**  
**expositor**  
**présentoir à petits fours**



	☐ cm	↑ cm	€
00193 0	Ø 14 / 11	16	4,80



**vielseitig  
einsetzbar  
für Küche  
und Buffet**



**Etagère**  
**etagère**  
**frutero**  
**corbeille à fruits**



ergonomischer Griff, stehend auf schwarzen Antirutsch-Füßen  
ergonomic handle, anti-slip-feets  
asa ergonómica, pies antideslizantes color negro  
anse ergonomique, pieds antidérapants noirs

	☐ cm	↑ cm	€
30325 6	30 x 30	35,5	11,00



**Brezel- oder Wurstständer**  
**pretzel-/ sausage stand**  
**soporte para embutidos**  
**support à bretzel ou à saucissons**



matt poliert  
 satin polished finish  
 acabado pulido satinado  
 poli satiné

	cm	cm	€
79554 9	Ø 21	50	45,00

**Hygieneschutz für Brezelständer**  
**hygienic cover**  
**cubierta higiénica antialiento**  
**pare-haleine**



	cm	cm	€
<b>NEW</b> 11558 3	15 x 20 x 15	50	19,00



11557  
 Hygieneschutz

**Brezel- oder Wurstständer**  
**pretzel-/ sausage stand**  
**soporte para embutidos**  
**présentoir à bretzels ou à saucissons**



Verkaufsständer Buchen-Holz versiegelt, bestens geeignet für die Präsentation von Brezeln, Würstchen, etc., Fuß Ø 22 cm  
 beech wood, ideal to present pretzels, sausages, etc.  
 madera de haya, ideal para presentar fiambres, salchichones etc.  
 en hêtre, idéal pour bretzels ou saucissons, etc.

	cm	cm	€
79553 2	Ø 28	50	19,00

**Hygieneschutz für Brezelständer**  
**hygienic cover**  
**cubierta higiénica antialiento**  
**pare-haleine**



	cm	cm	€
<b>NEW</b> 11557 6	20 x 20 x 20	50	21,00

inkl. Frischhaltehaube



**Hobel für Käse und Schokolade**  
**cheese / choco curler**  
**rizador para queso y chocolate**  
**frisette pour fromage et chocolat**



3-teilig: Platte Buchen-Holz versiegelt Ø 22 cm mit senkrechtem Stift + Hobel 7 cm + Haube Ø 15 x 10 cm, für Käse und Schokolade

3 pcs. set: wooden base Ø 22 cm with vertical bolt + plough 7 cm + cover Ø 15 x 10 cm, for cheese and choco

set de 3 piezas: base de madera Ø 22 cm, con eje vertical de 7 cm+ campana Ø 15 x 10 cm, para „rizar“ queso y chocolate

set 3 pièces pour „friser“ le fromage ou le chocolat: base bois Ø 22 cm, axe vertical ht. 7 cm, cloche Ø 15 x ht 10 cm

**macht das**  
**Schaben von**  
**hauchdünnen**  
**Röschen zum**  
**Kinderspiel**



	cm	cm	€
50002 0	Ø 22	15	15,00

# BUFFET-LEITER „GN“



## „LITTLE GN“



**Buffet-Leiter „LITTLE GN1/3“**  
buffet ladder  
dispensador en escalera  
présentoir buffet en escalier



4-teilig: 1 Leiter-Gestell, 3 GN1/3 Rahmen  
4 pcs.: 1 ladder, 3 single rings GN1/3  
4 pz: 1 soporte escalera, 3 aros sencillos GN1/3  
4 pc: 1 support escalier, 3 cercles simples GN1/3

	▣ cm	↑ cm	matches	€
11526 2	31,5 x 32	48	baskets/pans GN1/3	66,00



**Buffet-Leiter „LITTLE GN1/2“**  
buffet ladder  
dispensador en escalera  
présentoir buffet en escalier



4-teilig: 1 Leiter-Gestell, 3 GN1/2 Rahmen  
4 pcs.: 1 ladder, 3 single rings GN1/2  
4 pz: 1 soporte escalera, 3 aros sencillos GN1/2  
4 pc: 1 support escalier, 3 cercles simples GN1/2

	▣ cm	↑ cm	matches	€
11527 9	31,5 x 41,5	48	baskets/pans GN1/2	80,00

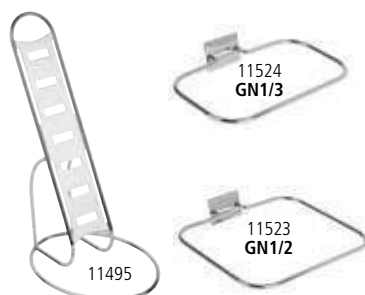

### Einzelteile / spare parts / piezas sueltas / pièces détachées

Leiter-Gestell / frame / estructura en escalera / support en escalier			
11495 1			29,00
Einzelring GN1/3 / single ring GN1/3 / aro sencillo GN1/3 / cercle simple GN1/3			
11524 8			13,00
Einzelring GN1/2 / single ring GN1/2 / aro sencillo GN1/2 / cercle simple GN1/2			
11523 1			17,50



## „BIG GN“



### Buffet-Leiter „BIG GN1/2“ buffet ladder dispensador en escalera présentoir buffet en escalier



- 5-teilig: 1 Leiter-Gestell, 4 GN1/2 Rahmen  
 5 pcs.: 1 ladder, 4 single rings GN1/2  
 5 pz: 1 soporte escalera, 4 aros sencillos GN1/2  
 5 pc: 1 support escalier, 4 cercles simples GN1/2

	☐ cm	↑ cm	matches	€
11528 6	31,5 x 56	66	baskets/pans GN1/2	129,00

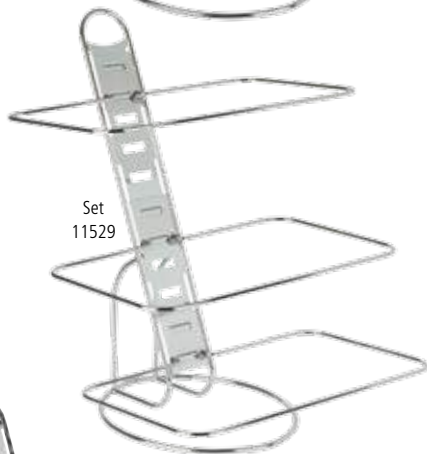

### Buffet-Leiter „BIG GN1/1“ buffet ladder dispensador en escalera présentoir buffet en escalier



- 4-teilig: 1 Leiter-Gestell, 3 GN1/1 Rahmen  
 4 pcs.: 1 ladder, 3 single rings GN1/1  
 4 pz: 1 soporte escalera, 3 aros sencillos GN1/1  
 4 pc: 1 support escalier, 3 cercles simples GN1/1

	☐ cm	↑ cm	matches	€
11529 3	52 x 59	66	baskets/pans GN1/1	129,00

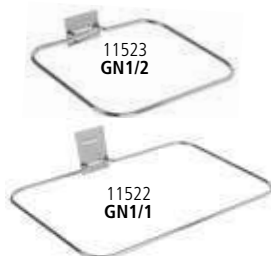

### Einzelteile / spare parts / piezas sueltas / pièces détachées

Leiter-Gestell / frame / estructura en escalera / support en escalier	11595 8	58,00
Einzelring GN1/2 / single ring GN1/2 / aro sencillo GN1/2 / cercle simple GN1/2	11523 1	17,50
Einzelring GN1/1 / single ring GN1/1 / aro sencillo GN1/1 / cercle simple GN1/1	11522 4	24,00

jede Schale  
ca. 2,5 Liter



11598  
12-teiliges Set

**Buffet-Leiter „BIG“**  
buffet ladder  
dispensador en escalera  
présentoir buffet en escalier



12-teiliges Set: 4 Glasschalen Ø 23 cm 2,5 Liter, 4 klappbare Schutzdeckel mit Beschriftungsfenster, 1 Leiter, 1 Doppelring, 2 Einzelringe, einfach und individuell zusammensetzbar

12 pcs. set: 4 glass bowls Ø 23 cm 2.5 litres, 4 hinged covers with card for inscription, 1 ladder, 1 double ring, 2 single rings, easy to fix and individual to use

set 12 pz: 4 boles vidrio Ø 23 cm 2,5 l, 4 tapas abatibles con ventana para etiqueta, 1 soporte escalera, 1 aro doble, 2 aros sencillos, fácil de montar, posible usar individualmente

12 éléments: 4 bols verre Ø 23 cm 2,5 l, 4 couvercles à charnière et fenêtre p/ étiquette, 1 support escalier, 1 cercle double, 2 cercles simples, montage facile, utilisable individuellement

	□ cm	↑ cm	€
11598 9	39 x 31	66	169,00

11-teiliges Set: 6 Glasschalen Ø 23 cm 2,5 Liter, 1 Leiter, 2 Doppelringe, 2 Einzelringe, einfach und individuell zusammensetzbar

11 pcs. set: 6 glass bowls Ø 23 cm 2.5 litres, 1 ladder, 2 double rings, 2 single rings, easy and individual to use

set 11 pz: 6 boles vidrio Ø 23 cm 2,5 l, 1 soporte escalera, 2 aros dobles, 2 aros sencillos, fácil montar, se puede usar individualmente

11 éléments: 6 bols verre Ø 23 cm 2,5 l, 1 support escalier, 2 cercles double, 2 cercles simples, montage facile, utilisable individuellement

11599 6	39 x 31	66	146,00
---------	---------	----	--------



11599  
11-teiliges Set

**Einzelteile / spare parts / piezas sueltas / pièces détachées**

Leiter-Gestell / frame / estructura en escalera / support en escalier

11595 8			58,00
---------	--	--	-------

Einzelring / single ring / aro sencillo / cercle simple

11596 5			12,60
---------	--	--	-------

Doppelring / double ring / aro doble / cercle double

11597 2			22,60
---------	--	--	-------

Schale / bowl / cuenco / bol

11875 1	Ø 23	10,5	4,20
---------	------	------	------

Schutzdeckel, mit vergoldetem Griff / cover, gold plated handle  
tapa, botón dorado / couvercle, bouton doré

11877 5	Ø 23,5		12,50
---------	--------	--	-------

Schutzdeckel, mit verchromtem Griff / cover, chrome plated handle  
tapa, botón cromado / couvercle, bouton chromé

11878 2	Ø 23,5		11,40
---------	--------	--	-------



**Fenster für Beschriftung**



jede Schale  
ca. 0,5 Liter



11498  
12-teiliges Set



11499  
11-teiliges Set

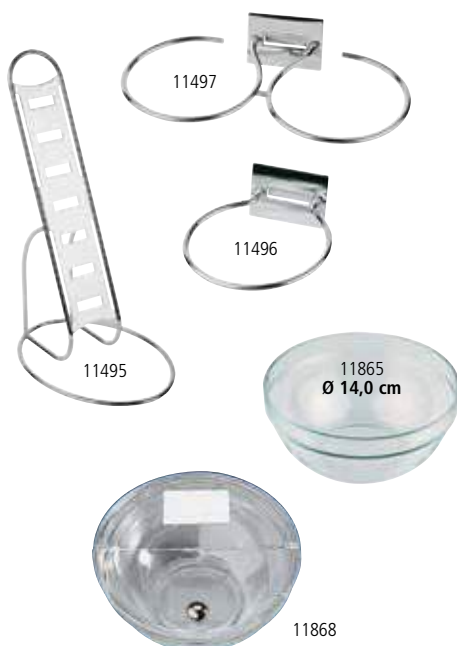

**Buffet-Leiter „LITTLE“**  
**buffet ladder**  
**dispensador en escalera**  
**présentoir buffet en escalier**



12-teiliges Set: 4 Glasschalen Ø 14 cm 0,5 Liter, 4 klappbare Schutzdeckel mit Beschriftungsfenster, 1 Leiter, 1 Doppelring, 2 Einzelringe, einfach und individuell zusammensetzbar

12 pcs. set: 4 glass bowls Ø 14 cm 0.5 litres, 4 hinged covers with card for inscription, 1 ladder, 1 double ring, 2 single rings, easy and individual to use

set de 12 pz: 4 boles vidrio Ø 14 cm 0,5 l, 4 tapas abatibles con ventana para etiqueta, 1 soporte escalera, 1 aro doble, 2 aros sencillos, fácil montaje, se puede usar individualmente

12 éléments: 4 bols verre Ø 14 cm 0,5 l, 4 couvercles à charnière et fenêtre p/ étiquette, 1 support escalier, 1 cercle double, 2 cercles simples, montage facile, utilisable individuellement

	▣ cm	↑ cm	€
11498 2	30 x 30	48	105,00

11-teiliges Set: 6 Glasschalen Ø 14 cm 0,5 Liter, 1 Leiter, 2 Doppelringe, 2 Einzelringe, einfach und individuell zusammensetzbar

11 pcs. set: 6 glass bowls Ø 14 cm 0.5 litres, 1 ladder, 2 double rings, 2 single rings, easy and individual to use

set de 11 pz: 6 boles vidrio Ø 14 cm 0,5 l, 1 soporte escalera, 2 aros dobles, 2 aros sencillos, fácil montaje, se puede usar individualmente

11 éléments: 6 bols verre Ø 14 cm 0,5 l, 1 support escalier, 1 cercle double, 2 cercles simples, montage facile, utilisable individuellement

11499 9	30 x 30	48	90,00
---------	---------	----	-------

**Einzelteile / spare parts / piezas sueltas / pièces détachées**

Leiter-Gestell / frame / marco solo en escalera / échelle support

11495 1			29,00
---------	--	--	-------

Einzelring / single ring / aro sencillo / cercle simple

11496 8			8,50
---------	--	--	------

Doppelring / double ring / aro sencillo / cercle double

11497 5			15,20
---------	--	--	-------

Schale / bowl / cuenco / bol

11865 2	Ø 14		2,20
---------	------	--	------

Schutzdeckel, mit vergoldetem Griff / cover, gold plated handle  
tapa, botón dorado / couvercle, bouton doré

11867 6	Ø 14,5		11,40
---------	--------	--	-------

Schutzdeckel, mit verchromtem Griff / cover, chrome plated handle  
tapa, botón cromado / couvercle, bouton chromé

11868 3	Ø 14,5		10,40
---------	--------	--	-------



11220  
GN1/1

**Tablett „SUNDAY“**  
tray  
bandeja  
plateau



hochglanzpoliert  
mirror polished finish  
acabado espejo pulido  
effet brillant



11210  
GN1/2



11211

	cm	cm	GN	€
11220 9	53 x 32,5	2	1/1	38,00
11210 0	32,5 x 26,5	2	1/2	22,00
11211 7	Ø 46	2		46,00

**Tablett „SUNDAY“**  
tray  
bandeja  
plateau



hochglanzpoliert, Griffe inkl. Fixierung, kein Verrutschen möglich, Nutzhöhe 4 cm  
mirror polished finish, with handles for extra secure stacking, distance 4 cm  
pulido espejo, con 2 asas para apilado muy estable, distancia 4 cm entre bandejas  
effet brillant, 2 anses pour empilement très stable, distance 4 cm entre plateaux



11222  
GN1/1



11212  
GN1/2

	cm	cm	GN	€
11222 3	53 x 32,5	6	1/1	52,00
11212 4	32,5 x 26,5	6	1/2	30,00





**Kühlbox „SUNDAY“**  
**cooling plate**  
**bandeja refrigerada**  
**présentoir buffet réfrigéré**



11230

3-teilig: 1 Schale inkl. Haubenfixierung + 1 Tablett + 1 Kühlakku, hochglanzpoliert, ohne Haube

3 pcs. set: 1 tray with cover holder + 1 tray + 1 cooler, mirror polished finish, without rolltop cover

3 piezas: 1 bandeja inox con fijaciones para campana + 1 bandeja inox + 1 acumulador de frío, campana no incluida

3 éléments: 1 plateau inox avec fixations pour la cloche + 1 plateau inox + 1 accum. de froid, cloche non incluse

	cm	cm	GN	€
11230 8	53,0 x 32,5	5	1/1	229,00

mit Haubenfixierung



11016

**Einzelteile / spare parts / piezas sueltas / pièces détachées**

Rolltop-Haube GN1/1 / rolltop cover GN1/1  
 campana rolltop GN1/1 / cloche rolltop GN1/1

11016 8	53,0 x 32,5	19		62,00
---------	-------------	----	--	-------

Kühlakku / cooler / acumulador de frío / accumulateur de froid

10782 3	41 x 21	2,5		14,20
---------	---------	-----	--	-------



10782

**Buffet-Gestell „SUNDAY“**  
**buffet stand**  
**expositor bufé**  
**présentoir buffet**



3-teiliges Set: 1 Glasschalen Ø 23 cm 2,5 Liter, 1 klappbarer Schutzdeckel, 1 Gestell

3 pcs. set: 1 glass bowls Ø 23 cm 2.5 litres, 1 hinged covers, 1 stand

3 piezas: 1 bol vidrio Ø 23 cm, 2,5 l, 1 tapa con bisagra, 1 soporte

3 éléments: 1 bol verre Ø 23 cm 2,5 l, 1 couvercle à charnière, 1 support

	cm	cm	€
11794 5	Ø 24	17	36,00

**Buffet-Gestell „SUNDAY“**  
**buffet stand**  
**expositor bufé**  
**présentoir buffet**



7-teiliges Set: 3 Glasschalen Ø 23 cm 2,5 Liter, 3 klappbare Schutzdeckel, 1 Gestell

7 pcs. set: 3 glass bowls Ø 23 cm 2.5 litres, 3 hinged covers, 1 stand

7 piezas: 3 boles vidrio Ø 23 cm, 2,5 l, 3 tapas con bisagra, 1 soporte

7 éléments: 3 bols verre Ø 23 cm 2,5 l, 3 couvercles à charnière, 1 support

	cm	cm	€
11795 2	61 x 24	35	119,00

**Buffet-Ständer „BIG“**  
buffet stand  
expositor de bufé  
présentoir buffet



7-teiliges Set: 3 Glasschalen Ø 23 cm 2,5 Liter, 3 klappbare Schutzdeckel, 1 Ständer  
7 pcs. set: 3 glass bowls Ø 23 cm 2.5 litres, 3 hinged covers, 1 stand  
7 piezas: 3 boles vidrio Ø 23 cm, 2,5 l, 3 tapas con bisagra, 1 soporte  
7 éléments: 3 bols verre Ø 23 cm 2,5 l, 3 couvercles à charnière, 1 support

	□ cm	↑ cm	€
11892 8	50 x 50	18	114,00

**Einzelteile / spare parts / piezas sueltas / pièces détachées**

Schale „CASUAL MAXI“ / bowl / cuenco / bol

	□ cm	↑ cm	ltr.		€
83702 7	Ø 23	10,5	2,50	○	9,00
83703 4	Ø 23	10,5	2,50	●	9,00



7-teiliges Set



passende Schale:  
83702 - weiß  
2,5 ltr.



passende Schale:  
83702 - schwarz  
2,5 ltr.



7-teiliges Set

**Buffet-Ständer „LITTLE“**  
buffet stand  
expositor de bufé  
présentoir buffet



7-teiliges Set: 3 Glasschalen Ø 14 cm 0,5 Liter, 3 klappbare Schutzdeckel, 1 Ständer  
7 pcs. set: 3 glass bowls Ø 14 cm 0,5 l, 3 hinged covers, 1 stand  
7 piezas: 3 boles vidrio Ø 14 cm, 0,5 l, 3 tapas con bisagra, 1 soporte  
7 éléments: 3 bols verre Ø 14 cm 0,5 l, 3 couvercles à charnière, 1 support

	□ cm	↑ cm	€
11893 5	30 x 30	14	84,00

**Einzelteile / spare parts / piezas sueltas / pièces détachées**

Schale „CASUAL MAXI“ / bowl / cuenco / bol

	□ cm	↑ cm	ltr.		€
83700 3	Ø 14	6,5	0,50	○	3,80
83701 0	Ø 14	6,5	0,50	●	3,80



passende Schale:  
83700 - weiß  
0,5 ltr.



passende Schale:  
83701 - schwarz  
0,5 ltr.



**Vorratsdose mit Deckel**  
canister with lid  
contenedor con tapa  
pot en verre avec couvercle



Glaskugel mit Schraubdeckel, aromadichtem Verschluss, 1 Stck.  
glass ball, aroma-tight screw cap, 1 pc.  
bola de cristal, tapa de rosca para conservar el aroma, 1 pz.  
boule de verre, bouchon à vis de l'arôme étanche, 1 pc.

	□ cm	↑ cm	ltr.	€
00637 9	12,5 x 19	18	1	6,40



**Buffet-Ständer „GOOD MORNING“**  
buffet stand  
expositor de bufé  
présentoir à céréales



4-teiliges Set  
Ahorn - 13965

4-teiliges Set: Holzständer inkl. 3 Gläser mit luftdichtem Klappdeckel

4 pcs. set: wood stand included 3 glass with airtight cover

4 pz: soporte, 3 boles de cristal, cierre hermético

4 pc. présentoir, 3 bols en verre, fermeture hermétique

	cm			€
13965 7	43 x 17	Holz, Ahorn / wood, maple	●	82,00
14965 6	43 x 17	Holz, Wenge / wood, wenge	●	82,00



4-teiliges Set  
Wenge - 14965

**Einzelteile / spare parts / piezas sueltas / pièces détachées**

Glas mit luftdichtem Klappdeckel / glass with airtight cover  
cristal, cierre hermético / verre, fermeture hermétique

	cm	↑ cm	ltr.	€
82328 0	12 x 12	22	2	6,20



**luftdichter  
Klappdeckel**

82328  
2 ltr.

**Idealer Müsli-Ständer!**

Buffet . Banquet  
buffet . banquet



**Cerealienspender „FRESH & EASY“**  
cereal dispenser  
dispensador de cereales  
distributeur de céréales



11805  
4,5 ltr.

Behälter herausnehmbar, „Feierabend-Deckel“ für das aromadichte Lagern, portionieren durch einfaches Drehen

removable canister, special lid to keep the cereals fresh, easy to use, rotate the button to get the muesli

contenedor movable, tapa especial para mantener los cereales frescos, fácil de usar, se gira el pomo para servir los cereales

réipient amovible, couvercle spécial pour conserver les céréales, usage facile en tournant le bouton

	cm	↑ cm	ltr.	€
11805 8	22 x 17,5	52	4,5	66,00
11807 2	22 x 35	52	2 x 4,5	122,00

**Einzelteile / spare parts / piezas sueltas / pièces détachées**

Kunststoffbehälter / canister / contenedor / réipient

11808 9			4,5	24,00
---------	--	--	-----	-------



11807  
2x 4,5 ltr.

**Portionieren durch  
einfaches „Drehen“**

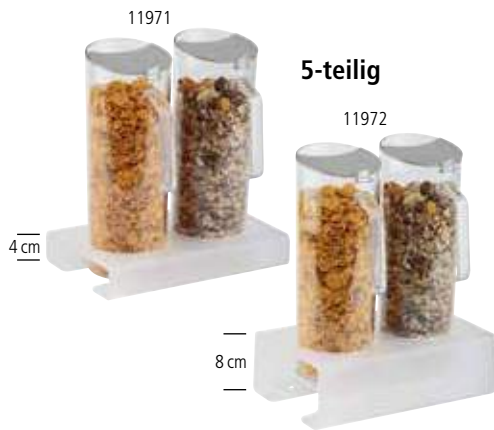

5-teilig

11972



7-teilig



11974



inklusive luftdichtem  
Frischhaltedeckel



**ideal für Stufen-Präsentationen**  
die 4 Sets sind durch die  
2 unterschiedlichen Höhen  
miteinander kombinierbar



**best for staged presentations**  
the 4 sets in 2 heights can be  
combined with each other

**Cerealien-Bar**  
**cereal-bar**  
**barra para dispensador de cereales**  
**bar à céréales**



5-teiliges Set, mit Ständerhöhe 4 oder 8 cm: 1 Ständer aus Acryl gefrostet und rutschfest + 2 Karaffen mit schwenkbarem Edelstahl-Deckel + 2 luftdichte Frischhaltedeckel

5 pcs. set, with stand heights 4 or 8 cm: 1 stand acryl frosted and anti-slip + 2 pitchers with stainless steel flap lid + 2 airtight covers

set 5 piezas con stands a diferentes alturas, 4 u 8 cm: 1 stand acryl + 2 jarras con tapa de solapa de acero inoxidable + 2 tapas herméticas adicionales

set 5 éléments avec supports à différentes hauteurs: 4 ou 8 cm - 1 support acrylique satiné antiglisse + 2 pichets à céréales avec couvercle à charnière inox + 2 couvercles hermétiques

	□ cm	↑ cm	ltr.	€
11971 0	26 x 17	28,5	2 x 1,5	64,00
11972 7	26 x 17	32,5	2 x 1,5	89,00

7-teiliges Set, mit Ständerhöhe 4 oder 8 cm: 1 Ständer aus Acryl gefrostet und rutschfest + 3 Karaffen mit schwenkbarem Edelstahl-Deckel + 3 luftdichte Frischhaltedeckel

7 pcs. set, with stand heights 4 or 8 cm: 1 stand acryl frosted and anti-slip + 3 pitchers with stainless steel flap lid + 3 airtight covers

set 7 piezas con stands a diferentes alturas, 4 u 8 cm: 1 stand acryl + 3 jarras con tapa de solapa de acero inoxidable + 3 tapas herméticas adicionales

set 7 éléments avec supports à différentes hauteurs: 4 ou 8 cm - 1 support acrylique satiné antiglisse + 3 pichets à céréales avec couvercle à charnière inox + 3 couvercles hermétiques

	□ cm	↑ cm	ltr.	€
11973 4	38 x 17	28,5	3 x 1,5	89,00
11974 1	38 x 17	32,5	3 x 1,5	114,00

**Cerealien-Karaffe**  
**cereal pitcher**  
**jarra de cereales**  
**pichet à céréales**



schwenkbarer Edelstahl-Deckel, inkl. luftdichtem Frischhaltedeckel

stainless steel flap lid, incl. 1 airtight cover

tapa de solapa de acero inoxidable, incluye otra tapa hermética

couvercle à charnière inox + couvercle hermétique

	□ cm	↑ cm	ltr.	€
10778 6	Ø 10	28	1,5	19,00

Frischhaltedeckel / includes conservation airtight lid

tapa de conservación hermética incluida / inclut couvercle hermétique

10668 0				2,40
---------	--	--	--	------



inklusive luftdichtem  
Frischhaltedeckel



designed by **CULTURE FORM**

**Cerealienspender „BRIDGE“**  
cereal dispenser  
dispensador de cereales  
distributeur de céréales



Behälter herausnehmbar, „Feierabend-Deckel“ für das aromadichte Lagern, portionieren durch einfaches Drehen

removable canister, special lid to keep the cereals fresh, easy to use, rotate the button to get the muesli

contenedor movible, tapa especial para mantener los cereales frescos, fácil de usar, se gira el pomo para servir los cereales

réceptient amovible, couvercle spécial pour conserver les céréales, usage facile en tournant le bouton



14987  
Ahorn



14987  
Wenge

	□ cm	↑ cm	litr.		€
13987 9	21 x 20	55,5	4,5	Ahorn	102,00
14987 8	21 x 20	55,5	4,5	Wenge	102,00

**Cerealienspender „CLASSIC“**  
cereal dispenser  
dispensador de cereales  
distributeur de céréales



8 ltr.

Portionieren durch einfaches Drehen, Behälter herausnehmbar

canister removable

contenedor movible

réceptient amovible

	□ cm	↑ cm	litr.	€
11833 1	35 x 26,5	68	8	184,00

Portionieren durch  
einfaches „Drehen“



**Cerealienspender „CLASSIC DUO“**  
cereal dispenser  
dispensador de cereales  
distributeur de céréales



2 x 8 ltr.

Portionieren durch einfaches Drehen, Behälter herausnehmbar

canister removable

contenedor movible

réceptient amovible

	□ cm	↑ cm	litr.	€
11834 8	35 x 50	68	2 x 8	334,00

Portionieren durch  
einfaches „Drehen“





3 x  
4,5 ltr.



drehbar

Top-Qualität  
bruchfest durch  
Polycarbonat

**Cerealienspender „ROTATION“**  
cereal dispenser  
dispensador de cereales  
distributeur de céréales



matt poliert, drehbarer massiver Ständer, Behälter herausnehmbar, inkl. Frischhaltedeckel  
satin polished finish, rotating food, canister removable, incl. airtight covers  
pulido acabado satinado, giratorio, incluye tapas herméticas  
mat satiné, rotatif, inclut couvercles hermétiques

	□ cm	↑ cm	ltr.	€
11970 3	Ø 38	54	3 x 4,5	310,00

**Einzelteile / spare parts / piezas sueltas / pièces détachées**

Kunststoffbehälter / canister / contenedor / récipient	€
11808 9	24,00

**Portionieren durch  
einfaches „Drehen“**



3 x  
4,5 ltr.



drehbar

Top-Qualität  
bruchfest durch  
Polycarbonat

**Cerealienspender „ROTATION“**  
cereal dispenser  
dispensador de cereales  
distributeur de céréales



Buchen-Holz versiegelt, drehbarer massiver Ständer, Behälter herausnehmbar, inkl. Frischhaltedeckel

wood beech covered waterproof, rotating foot, canister removable, incl. airtight cover

tapa en madera de haya resistente al agua, pie giratorio, recipiente removible, incluye tapa hermética

couvercle en hêtre traitée contre l'humidité, pied rotatif, récipients démontables, inclut couvercles hermétiques

	□ cm	↑ cm	ltr.	€
11975 8	Ø 38	54	3 x 4,5	314,00

**Einzelteile / spare parts / piezas sueltas / pièces détachées**

Kunststoffbehälter / canister / contenedor / récipient	€
11808 9	24,00

**Portionieren durch  
einfaches „Drehen“**



**Service-Tower  
service tower  
service tower  
tour de service**



Präsentations- und Spendersystem, bei minimalen Platzbedarf, optimale Wertschöpfung, zum Beispiel im Bereich der Besteckausgabe, Kaffeestationen, Speiseausgaben, Verkaufstheken, etc.

Presentation and dispenser system, the products find their best creation of value at minimal need of space, for example in the range of coffeestations, food service, counters etc.

sistema de presentación y dispensador, con el mínimo espacio conseguirá una excelente presentación de sus productos, por ejemplo en la zona del café, comidas, etc.

système de présentation et distribution, très élégant dans un espace minimum, idéal pour la zone café, coin repas, etc.



11422

**schwerer Basisfuß,  
rutschfest**

**5 oder 6-teilig: Basisfuß + Rückwand aus dunklem Holz**

**5 or 6 pcs. set: base + backplane made of dark wood**

**set de 5 o 6 elementos: base + trasera de madera oscura**

**set de 5 ou 6 éléments: socle + paroi en bois foncé**

	□ cm	↑ cm		€
11431 9	26 x 18	43	2x Schütte, tief + 1x Schütte, flach 2 deep ones + 1 flat one 2 rampas hondas + 1 plana 2 rampes profondes + 1 plates	94,00
11421 0	26 x 18	57,5	2x Schütte, tief + 2x Schütte, flach 2 deep ones + 2 flat ones 2 rampas hondas + 2 planas 2 rampes profondes + 2 plates	114,00
11432 6	26 x 18	43	3x Schütte, tief / 3 bowls, deep ones 3 rampas hondas / 3 rampes profondes	94,00
11422 7	26 x 18	57,5	4x Schütte, tief / 4 bowls, deep ones 4 rampas hondas / 4 rampes profondes	114,00



11433

**5 oder 6-teilig: Basisfuß + Rückwand aus Acryl gefrostet**

**5 or 6 pcs. set: base + backplane made of acrylic frosted**

**set de 5 o 6 elementos: base + trasera de acrilico opaco mate**

**set de 5 ou 6 éléments: socle + paroi en acrylique mat**

11433 3	26 x 18	43	2x Schütte, tief + 1x Schütte, flach 2 deep ones + 1 flat one 2 rampas hondas + 1 plana 2 rampes profondes + 1 plate	94,00
11423 4	26 x 18	57,5	2x Schütte, tief + 2x Schütte, flach 2 deep ones + 2 flat ones 2 rampas hondas + 2 planas 2 rampes profondes + 2 plates	114,00
11434 0	26 x 18	43	3x Schütte, tief / 3 bowls, deep ones 3 rampas hondas / 3 rampes profondes	94,00
11424 1	26 x 18	57,5	4x Schütte, tief / 4 bowls, deep ones 4 rampas hondas / 4 rampes profondes	114,00

**Einzelteile / spare parts / piezas sueltas / pièces détachées**

Basisfuß / base / pie de la base / pied de la base

11435 7				41,00
---------	--	--	--	-------

Rückwand Holz / backplane made of wood / trasera de madera / arrière bois

11436 4	44,5 x 24	für 3 Schütten		33,50
11426 2	60 x 24	für 4 Schütten		47,50

Rückwand Acryl / backplane made of acrylic / trasera acrílica / arrière acrylique

11437 1	44,5 x 24	für 3 Schütten		33,50
11427 2	60 x 24	für 4 Schütten		47,50

Schütte, tief / bowl, deep / rampa, honda / rampe profonde

11438 8	22 x 14	7 / 5		6,30
---------	---------	-------	--	------

Schütte, flach / bowl / rampa plana / rampe plate

11439 5	22 x 13	3 / 1		6,30
---------	---------	-------	--	------



11438



11439



**Multi-Rack**  
**multi rack**  
**dispensador en escalera**  
**support multiple**



2-stufig, 3-teilig: 1 Gestell matt poliert + 2 Schütten aus transparent gefrostetem Kunststoff, je ca. 1 Liter

2-tier, 3 pcs. set: 1 frame satin polished finish + 2 bowls frosted plastic, approx. 1 liter

2 alturas - set de 3 pz: 1 soporte inox mate satinado + 2 bols plástico glaseado, aprox. 1 litro

2 niveaux - set de 3 éléments: 1 support satiné + 2 bols plastique mat, approx. 1 litre

	☐ cm	↑ cm	€
11442 5	19 x 24	28	36,60



**Multi-Rack**  
**multi rack**  
**dispensador en escalera**  
**support multiple**



3-stufig, 4-teilig: 1 Gestell matt poliert + 3 Schütten aus transparent gefrostetem Kunststoff, je ca. 1 Liter

3-tier, 4 pcs. set: 1 frame satin polished finish + 3 bowls frosted plastic, approx. 1 liter

3 alturas, set de 4 piezas: 1 estructura inox satinado + 3 bols de plástico glaseado, aprox, 1 litro

3 niveaux - set de 4 éléments: 1 structure inox poli satin, 3 bols plastique mat, approx. 1 litre

	☐ cm	↑ cm	€
11444 9	19 x 24	41	42,90



**Multi-Rack**  
**multi rack**  
**dispensador en escalera**  
**support multiple**



3-stufig, 4-teilig: 1 Gestell matt poliert + 1 Schütte aus transparent gefrostetem Kunststoff, ca. 1 Liter + 2 Rutschen aus transparent gefrostetem Kunststoff

3-tier, 4 pcs. set: 1 frame satin polished finish + 1 bowl frosted plastic, approx. 1 liter + 2 slides frosted plastic

3 alturas, set de 4 piezas, 1 soporte inox satinado + 1 bol de plástico glaseado, aprox, 1 litro + 2 bols con „tobogán“ en plástico glaseado

3 niveaux - set de 4 éléments: 1 structure inox poli satin + 1 bol plastique mat approx. 1 litre + 2 bols avec „toboggan“

	☐ cm	↑ cm	€
11449 4	19 x 24	41	42,90





**Multi-Rack  
multi rack  
dispensador en escalera  
support multiple**



4-stufig, 5-teilig: 1 Gestell matt poliert + 4 Schütten aus transparent gefrostedem Kunststoff, je ca. 1 Liter

4-tier, 5 pcs. set: 1 frame satin polished finish + 4 bowls frosted plastic, approx. 1 liter

4 alturas, set de 5 piezas: 1 estructura inox satinado + 4 bols de plástico glaseado, aprox, 1 litro

4 niveaux - set de 5 éléments: 1 structure inox poli satin, 4 bols plastique mat, approx. 1 litre

	□ cm	↑ cm	€
11446 3	19 x 31	53	54,00



**Multi-Rack  
multi rack  
dispensador en escalera  
support multiple**



4-stufig, 5-teilig: 1 Gestell matt poliert + 3 Schütten aus transparent gefrostedem Kunststoff, je ca. 1 Liter + 1 Rutsche aus transparent gefrostedem Kunststoff

4-tier, 5 pcs. set: 1 frame satin polished finish + 3 bowls frosted plastic, approx. 1 liter + 1 slide frosted plastic

4 alturas, set de 5 piezas: 1 estructura inox satinado + 3 bols de plástico glaseado, aprox, 1 litro + 1 bol con „tobogán“ de plástico efecto glaseado

4 niveaux - set de 5 éléments: 1 structure inox poli satin + 3 bols plastique mat approx. 1 litre + 1 bol avec „toboggan“

	□ cm	↑ cm	€
11451 7	19 x 31	53	54,00

11455  
Schütte



11456  
Rutsche



**Ergänzung für alle Multi-Racks  
supplement for all multi racks  
suplemento para todos los dispensadores  
compléments pour support Multi-Rack**



Schütte und Rutsche aus transparent gefrostedem Kunststoff

bowl and slide frosted plastic

bol y tobogán de plástico glaseado

en plastique mat

		€
11455 5	Schütte / canister / bol / bol	6,50
11456 2	Rutsche / slide / tobogán / toboggan	6,50



### Schälchenspender „MINI“ bowl holder rack dispensador para bols porte-bols



geeignet für Schalen Ø 6 cm, bestückbar mit bis zu 36 Schalen  
for bowls Ø 6 cm, suitable for 36 bowls  
para bols de Ø 6 cm, apto para 36 bols  
pour bols de Ø 6 cm, maxi 36 bols

	☐ cm	↑ cm		€
11981 9	Ø 14	25,5	Ständer inkl. 36 Glasschalen, Ø 6 cm frame with 36 bowls, Ø 6 cm soporte con 36 bols, Ø 6 cm support livré avec 36 bols en verre Ø 6 cm	91,00
11980 2	Ø 14	25,5	Ständer ohne Schalen frame without bowls soporte sin bols support sans bols	45,00



### Schälchenspender „MEDIUM“ bowl holder rack dispensador para bols porte-bols



geeignet für Schalen Ø 7,5 cm, bestückbar mit bis zu 36 Schalen  
for bowls Ø 7,5 cm, suitable for 36 bowls  
para bols de Ø 7,5 cm, apto para 36 bols  
pour bols de Ø 7,5 cm, maxi 36 bols

	☐ cm	↑ cm		€
11991 8	Ø 17,5	25,5	Ständer inkl. 36 Glasschalen, Ø 7,5 cm frame with 36 bowls, Ø 7,5 cm soporte con 36 bols, Ø 7,5 cm support livré avec 36 bols en verre Ø 7,5 cm	92,00
11990 1	Ø 17,5	25,5	Ständer ohne Schalen frame without bowls soporte sin bols support sans bols	46,00



### Schälchenspender „MAXI“ bowl holder rack dispensador para bols porte-bols



geeignet für Schalen Ø 14 cm, bestückbar mit bis zu 15 Schalen  
for bowls Ø 14 cm, suitable for 15 bowls  
para bols Ø 14cm, apto para 15 bols  
pour bols Ø 14cm, pour 15 bols

	☐ cm	↑ cm		€
11993 2	Ø 17,5	36,5	Ständer inkl. 15 Glasschalen, Ø 14 cm frame with 15 bowls, Ø 14 cm soporte con 15 bols, Ø 14 cm support livré avec 15 bols en verre Ø 14 cm	64,00
11989 5	Ø 17,5	36,5	Ständer inkl. Melaminschalen, Ø 14 cm frame with melamine bowls, Ø 14 cm soporte con bols de melamina Ø 14 cm support livré avec 15 bols en mélamine Ø 14 cm	89,00
11992 5	Ø 17,5	36,5	Ständer ohne Schalen frame without bowls soporte sin bols support sans bols	39,00



**Schälchenspender „MINI“**  
**bowl holder**  
**rack dispensador para bols**  
**porte-bols**



geeignet für Schalen Ø 6 cm, bestückbar mit bis zu 36 Schalen  
 for bowls Ø 6 cm, suitable for 36 bowls  
 para bols de Ø 6 cm, apto para 36 bols  
 pour bols de Ø 6 cm, maxi 36 bols

	□ cm	↑ cm		€
11986 4	Ø 14	25,5	Ständer inkl. 36 Melaminschalen, Ø 6 cm frame with 36 melamine bowls, Ø 6 cm soporte con 36 bols de melamina Ø 6 cm support avec 36 bols en mélamine Ø 6 cm	84,00
11980 2	Ø 14	25,5	Ständer ohne Schalen frame without bowls soporte sin bols support sans bols	45,00



**Schälchenspender „MEDIUM“**  
**bowl holder**  
**rack dispensador para bols**  
**porte-bols**



geeignet für Schalen Ø 7,5 cm, bestückbar mit bis zu 36 Schalen  
 for bowls Ø 7,5 cm, suitable for 36 bowls  
 para bols de Ø 7,5 cm, apto para 36 bols  
 pour bols de Ø 7,5 cm, maxi 36 bols

	□ cm	↑ cm		€
11987 1	Ø 17,5	22,5	Ständer inkl. 36 Melaminschalen, Ø 7,5 cm frame with 36 melamine bowls, Ø 7,5 cm soporte con 36 bols de melamina, Ø 7,5 cm support avec 36 bols en mélamine Ø 7,5 cm	99,00
11990 1	Ø 17,5	25,5	Ständer ohne Schalen frame without bowls soporte sin bols support sans bols	46,00



2 Größen  
 2 sizes

**Schälchen „CASUAL MINI“**  
**bowl**  
**cuenco**  
**bol mini**



	□ cm	↑ cm	ltr.		€
83880 2	Ø 6,0	2,5	0,02	○	1,50
83881 9	Ø 7,5	3,5	0,05	○	1,90



**Schale „CASUAL MAXI“**  
**bowl**  
**cuenco**  
**bol**



	□ cm	↑ cm	ltr.		€
83700 3	Ø 14	6,5	0,50	○	3,80
83701 0	Ø 14	6,5	0,50	●	3,80

# BUFFET-SET PURE designed by CULTURE FORM



stapelbar  
stackable  
apilables  
empilable



mit Antirutsch-Füßchen  
non-slip feet  
con pies antideslizantes  
avec pieds antidérapants

40296  
Auslage Tablett  
40 x 30 cm



09012  
Basisteil  
schwarz



09012  
Basisteil  
schwarz



09000  
Set, 4-teilig



09016  
Schneidebrett



09010  
Edelstahltablett



09013  
Rolltop-Haube

**Kühl-Akkus halten  
Ihre Speisen bis  
zu 6 Stunden kühl**

**Buffet-Set, eckig „PURE“  
buffet set, rectangular  
set de bufé, rectangolar  
présentoir pour le buffet, rectangulaire**



4-teilig: Box, Tablett, 2 Kühlakkus  
4 pcs.: box, tray, 2 cooler  
4 piez.: box, bandeja, 2 enfriadores  
4 éléments: caisson, 2 plateau, bac

	cm	cm		€
09000 2	43,5 x 32,5	6	○	54,00
09001 9	43,5 x 32,5	6	●	54,00

**Einzelteile / spare parts / piezas sueltas / pièces détachées**

Edelstahltablett / tray / bandeja / plateau				
09010 1	43,5 x 32,5	1,5		19,00

Basisteil / base / base / base				
09011 8	42,5 x 31,5	6	○	22,00
09012 5	42,5 x 31,5	6	●	22,00

Rolltop-Haube / rolltop cover / campana abatible / cloche basculante				
09013 2	44 x 33,5	17		24,00

Holzschneidebrett / wooden board / tablero de madera / planche à découper				
09016 3	43,5 x 32,5	2	Ahorn / maple	46,50

Auslage Tablett flach (Bäcker-Maß) / display tray flat (baker size) bandeja de presentación (tamaño panadería) / plateau de présentation (dimensions boul-pâte)				
40296 6	40 x 30	1		13,50

Kühlakku / cooler / acumulador de frío / accumulateur de froid				
10791 5	25 x 19	2,5	○	7,20



09003  
Set, 3-teilig



09023  
Rolltop-Haube

09003  
Set, 3-teilig (ohne Haube)



09020  
Edelstahltablett

**Kühl-Akkus halten  
Ihre Speisen bis  
zu 6 Stunden kühl**

**Buffet-Set, rund „PURE“  
buffet set, round  
set de bufé, redonda  
présentoir pour le buffet, rond**



3-teilig: Box, Tablett, 1 Kühlakku  
3 pcs.: box, tray, 1 cooler  
3 piez.: box, bandeja, 1 enfriador  
3 éléments: caisson, 1 plateau, bac

	cm	cm		€
09002 6	Ø 38	6	○	40,00
09003 3	Ø 38	6	●	40,00

**Einzelteile / spare parts / piezas sueltas / pièces détachées**

Edelstahltablett / tray / bandeja / plateau				
09020 0	Ø 38	1,5		15,00

Basisteil / base / base / base				
09021 7	Ø 37	6	○	19,00
09022 4	Ø 37	6	●	19,00

Rolltop-Haube / rolltop cover / campana abatible / cloche basculante				
09023 1	Ø 38	20		19,00

Holzschneidebrett / wooden board / tablero de madera / planche à découper				
09026 2	Ø 38	2	Ahorn / maple	30,00

Kühlakku / cooler / acumulador de frío / accumulateur de froid				
10791 5	25 x 19	2,5	○	7,20

designed by **CULTURE FORM**



**Buffet-Brett „FISCH“  
board  
tabla para el bufé  
planche à découper buffet**



Buchenholz, mit Antirutsch-Füßchen  
beech wood, with non-slip feet  
haya, pies antideslizantes  
hêtre, pieds antidérapants

	cm	cm	€
00860 1	76 x 23	2,5	37,00

designed by **CULTURE FORM**



**Buffet-Brett „RIND“  
board  
tabla para el bufé  
planche à découper buffet**



Buchenholz, mit Antirutsch-Füßchen  
beech wood, with non-slip feet  
haya, pies antideslizantes  
hêtre, pieds antidérapants

	cm	cm	€
00861 8	62 x 34	2,5	39,50

designed by **CULTURE FORM**



**Buffet-Brett „SCHWEIN“  
board  
tabla para el bufé  
planche à découper buffet**



Buchenholz, mit Antirutsch-Füßchen  
beech wood, with anti-slip feet  
haya, pies antideslizantes  
hêtre, pieds antidérapants

	cm	cm	€
00862 5	66 x 30	2,5	39,50

designed by **CULTURE FORM**



18388



**Buffet-Brett „TRAUBE“  
board  
tabla para el bufé  
planche à découper buffet**

Buchenholz, Antirutsch-Füßchen  
beech wood, non-slip feet  
haya, pies antideslizantes  
hêtre, pieds antidérapants

	cm	cm	€
00863 2	43,5 X 38	2,5	34,20

**Rolltophaube / rolltop cover / campana abatible / cloche basculante**

18388 9	Ø 38	20	19,40
---------	------	----	-------

designed by **CULTURE FORM**



**Buffet-Brett „XXL“**  
board  
tabla para el bufé  
planche à découper buffet



Buchenholz geölt, mit Antirutsch-Füßchen  
beech wood oiled, with non-slip feet  
madera de haya tratada con aceite, pies antideslizantes  
bois hêtre huilé, pieds antiglisse

	□ cm	↑ cm	€
00866 3	Ø 50	4,5	74,00

**passende Rolltophaube / suitable rolltop cover / campana abatible / cloche basculante**

18380 3	Ø 50	26	54,00
---------	------	----	-------



designed by **CULTURE FORM**



**Buffet-Brett**  
board  
tabla para el bufé  
planche à découper buffet



Buchenholz, mit Antirutsch-Füßchen  
beech wood, with non-slip feet  
haya, pies antideslizantes  
hêtre, pieds antidérapants

	□ cm	↑ cm	€
00865 6	58 x 38	2,5	42,00

**passende Rolltophaube / suitable rolltop cover / campana abatible / cloche basculante**

	□ cm	↑ cm	Seite/page	€
11016 8	53,0 x 32,5	19	505	62,00
11008 3	53,0 x 32,5	19	505	59,90
11010 6	53,0 x 32,5	19	505	59,90

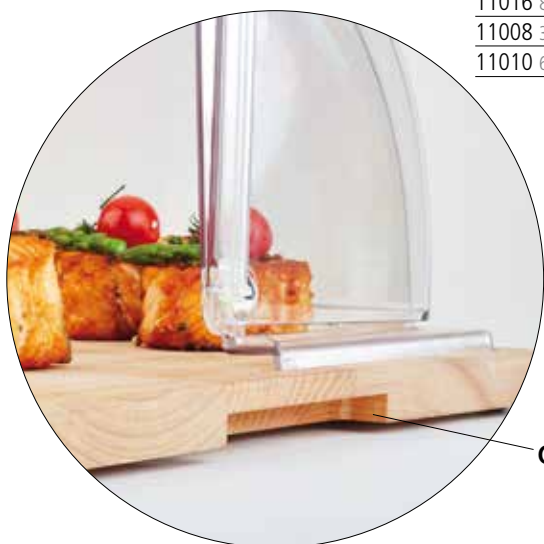

Griffmulde



3-tlg. Set



Haube mit verchromten Griff

**Käseglocken-Set „BRAZIL“**  
rolltop-set  
set rolltop  
set cloche à fromage



3-teilig: Tablett + Holzschneidebrett + Rolltop-Haube glasklar, rutschfeste Haubenfixierung  
3 pcs. set: tray + wooden board + rolltop cover, cover non-slip fixed  
set de 3 piezas: bandeja + tablero de madera + campana abatible, fijación antideslizante  
set de 3 pièces: plateau + planche à découper + cloche abattante, fixation antiglisse

	☐ cm	↑ cm	€
09085 9	Ø 45	24	72,00

**Rolltop-Set**  
rolltop-set  
set rolltop  
set cloche à fromage



09080  
2-tlg. Set

Ø 38 cm!

2-teilig: Tablett + Rolltop-Haube glasklar, rutschfeste Haubenfixierung  
2 pcs. set: tray + rolltop cover, cover non-slip fixed  
set de 2 piezas: bandeja + campana abatible fijación antideslizante  
set de 2 pièces: plateau + cloche abattante, fixation antiglisse

	☐ cm	↑ cm	€
09080 4	Ø 38	24	34,00
09099 6	Ø 50	28	75,00



09099  
2-tlg. Set

Ø 50 cm!

klappbar





**Haube mit verchromten Griff  
2-tlg. Set**

**Rolltop-Set  
rolltop-set  
set rolltop  
set rolltop**



2-teilig: Schneidbrett marmoriert + Rolltop-Haube glasklar, rutschfeste Haubenfixierung  
2 pcs. set: plastic board + rolltop cover, cover non-slip fixed  
set de 2 piezas: tablero de plástico + tapa abatible, tapa antideslizante  
set de 2 pièces: planche à découper + cloche abattante, fixation antiglisse

	□ cm	↑ cm	€
09081 1	Ø 38	24	45,00

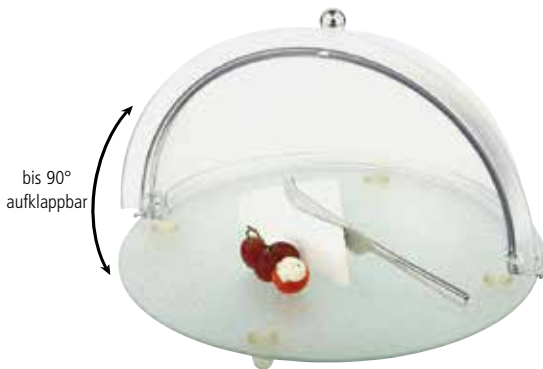

00978  
Ø 38 cm  
**2-tlg. Set**

**Buffet-Set  
buffet set  
set de bufé  
présentoir pour le buffet**



2-teilig: Platte + Rolltop-Haube, schneidfeste und porenfreie Oberfläche, rutschfeste Haubenfixierung, Platte mit rutschfesten Füßen  
2 pcs. set: glass board + rolltop cover, scratch-resistant surface, cover non-slip fixed, non-slip feet  
set de 2 piezas: bandeja vidrio redonda + campana abatible, fijación antideslizante, pies antideslizantes  
set de 2 pièces: plateau verre rond + cloche abattante, fixation antiglisse et pieds antidérapants

	□ cm	↑ cm	€
00978 3	Ø 38	23	32,00

**Einzelteile / spare parts / piezas sueltas / pièces détachées**

Rolltop-Haube mit Löchern / rolltop cover / campana abatible / cloche basculante			
18394 0	Ø 38	20	20,00

Glasplatte / glass plate / bandeja de vidrio / plateau verre			
00972 1	Ø 38	3	12,50



Ø 38 cm

83869

**Servierplatte  
plate  
bandeja para servir  
plat de service**



mit Antirutsch-Füßchen  
non-slip feet  
con pies antideslizantes  
avec pieds antidérapants

	□ cm	↑ cm	€
83869 7	Ø 38	2,5	20,00



18388

**passendes Zubehör / suitable accessories  
accessorios a juego / accessoires assortis**



Rolltop-Haube / rolltop cover / campana abatible / cloche basculante			
18388 9	Ø 38	20	mit verchromtem Kugelgriff with chrome plated handle con pomo cromado avec bouton chromé
			19,40



09100



09102



09104

**Buffet-Vitrine  
showcase  
vitrina de bufé  
vitrine de buffet**



1 transparente Rolltop-Haube beidseitig aufklappbar + 1 Schale (ABS)  
+ 1 Edelstahl-Tablett 39 x 28 cm + 2 Kühl-Akkus

1 transparent rolltop cover + 1 tray (ABS) + 1 stainless tray 39 x 28 cm + 2 coolers,  
demountable

1 tapa abatible transparente + 1 bandeja (ABS) + 1 bandeja 39x28cm + 2 enfriadores,  
desmontable

1 cloche transparente ouverture 2 côtés + 1 caisson (ABS) + 1 plateau inox 39 x 28 cm + 2  
accumulateurs de froid, démontable

	cm	↑ cm		€
09100 9	44 x 32	20,5	○	35,00
09102 3	44 x 32	20,5	●	35,00
09104 7	44 x 32	20,5	●	35,00

**Einzelteile / spare parts / piezas sueltas / pièces détachées**

Kühlakku / cooler / acumulador de frío / accumulateur de froid

11101 1	16 x 7,5	2,0	4 pcs.	4,70
---------	----------	-----	--------	------

Edelstahl-Tablett / stainless steel tray / bandeja de acero inoxidable / plateau inox

90902 1	39 x 28			5,30
---------	---------	--	--	------

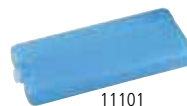

**Kühl-Akkus halten  
Ihre Speisen bis  
zu 6 Stunden kühl**

11101

**Thermo Tablett Set  
thermo tray  
bandeja termo  
caisson thermo**



1 stabile Schale + 1 Edelstahl-Tablett + 2 Kühlakkus + 1 Frischhaltehaube

1 plastic tray + 1 stainless tray + 2 coolers + 1 cover

1 bandeja de plástico + 1 bandeja inox + 2 acumuladores + 1 campana

1 plateau plastique + 1 plateau inox + 2 accumulateurs de froid + 1 cloche



**blaue Kunststoffschale  
und blauer Haubengriff**

	cm	↑ cm		€
09090 3	43 x 29	14		19,00

**Einzelteile / spare parts / piezas sueltas / pièces détachées**

Kühlakku / cooler / acumulador de frío / accumulateur de froid

11101 1	16 x 7,5	2,0	4 pcs.	4,70
---------	----------	-----	--------	------

Haube / cover / campana / cloche

90901 4	43 x 29	14		4,40
---------	---------	----	--	------

Edelstahl-Tablett / stainless steel tray / bandeja de acero inoxidable / plateau inox

90902 1	39 x 28			5,30
---------	---------	--	--	------



11101

**Kühl-Akkus halten  
Ihre Speisen bis  
zu 6 Stunden kühl**



**Buffet-Vitrine „DOPPELDECKER“  
showcase  
vitrina de bufé, 2 alturas  
vitrine de buffet double**



2 transparente Rolltop-Hauben beidseitig aufklappbar + 2 Edelstahl-Tabletts 39 x 28 cm + 4 Kühl-Akkus, platzsparend lagerbar

2 transparent rolltop cover + 2 tray 39 x 28 cm + 4 coolers, demountable, space saving

2 campanas abatibles por ambos lados + 2 bandejas 39 x 28 cm + 4 acumuladores, desmontable, ahorra espacio

2 cloches transparentes abattantes 2 côtés + 2 plateaux 39 x 28 cm + 4 accumulateurs de froid, gain d'espace

	□ cm	↑ cm		€
09200 6	44 x 32	44	○	69,50
09202 0	44 x 32	44	●	69,50
09204 4	44 x 32	44	●	69,50



**Einzelteile / spare parts / piezas sueltas / pièces détachées**

Kühlakku / cooler / acumulador de frío / accumulateur de froid

11101 1	16 x 7,5	2,0	4 pcs.	4,70
---------	----------	-----	--------	------

Edelstahl-Tablett / stainless steel tray / bandeja de acero inoxidable / plateau inox

90902 1	39 x 28			5,30
---------	---------	--	--	------

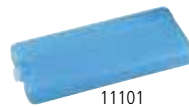

**Kühl-Akkus halten  
Ihre Speisen bis  
zu 6 Stunden kühl**

11101



**blaue Kunststoffschale**

**Thermo Tablett Set  
thermo tray  
bandeja termo  
plateau thermo**



1 stabile Schale + 1 Edelstahl-Tablett rostfrei + 2 Kühlakkus + 1 Frischhaltehaube

1 plastic tray + 1 stainless tray + 2 coolers + 1 cover

1 bandeja de plástico + 1 bandeja de acero inoxidable + 2 enfriadores + 1 campana

1 plateau plastique renforcé + 1 plateau inox + 2 accumulateurs de froid + 1 cloche

	□ cm	↑ cm		€
09093 4	Ø 35	15		19,00

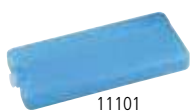

**Kühl-Akkus halten  
Ihre Speisen bis  
zu 6 Stunden kühl**

11101

**Einzelteile / spare parts / piezas sueltas / pièces détachées**

Kühlakku / cooler / acumulador de frío / accumulateur de froid

11101 1	16 x 7,5	2,0	4 pcs.	4,70
---------	----------	-----	--------	------



**Kühltablett „TOP FRESH GN1/1“**  
**Refrigerated buffet display**  
**expositor bufé frío**  
**plateau buffet froid**



4-teilig: 1 Holzbox mit Kunststoffwanne + 1 Tablett GN1/1 + 2 Kühlakkus  
 4 pcs. set: 1 woodbox with plastic insert + 1 stainless tray GN1/1 + 2 coolers  
 set de 4 piezas: 1 base madera + 1 bandeja inox GN1/1 + 2 acumuladores de frío  
 set de 4 pièces: 1 base bois + 1 plateau inox GN1/1 + 2 accus de froid (cloche non incluse)

	cm	cm	€
11540 8	60 x 41	5	174,00



**passendes Zubehör / suitable accessories / accesorios a juego / accessoires assortis**

Rolltop-Haube GN1/1, vergoldeter Griff / rolltop cover, gold plated handle  
 campana rolltop, pomo dorado / cloche rolltop, bouton doré

11008 3	53,0 x 32,5	19	59,90
---------	-------------	----	-------

Rolltop-Haube GN1/1, verchromter Griff / rolltop cover, chrome plated handle  
 campana rolltop, pomo cromado / cloche rolltop, bouton chromé

11010 6	53,0 x 32,5	19	59,90
---------	-------------	----	-------

Kühlakku / cooler / acumulador de frío / accumulateur de froid

10779 3	25 x 19	2,5	7,40
---------	---------	-----	------

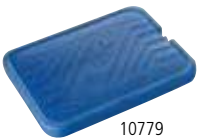

**Kühl-Akkus halten Ihre Speisen bis zu 6 Stunden kühl**

10779

**Buche (wasserfest lackiert)**



**Kühltablett Buffet-Vitrine „DOPPELDECKER“**  
**Cooling buffet display**  
**expositor bufé frío**  
**vitrine buffet**



12-teilig: 2 Kästen Buchen-Holz versiegelt + 2 Tablett GN1/1 + 4 Kühlakkus + 4 Stangen, ohne Hauben

12 pcs. set: 2 beech wood boxes waterproof + 2 trays GN1/1 + 4 coolers + 4 fittings, without covers

set de 12 piezas: 2 bases madera tratada + 2 bandejas inox GN1/1 + 4 enfriadores + 4 pies (campanas no incl.)

set de 12 pièces: 2 caissons bois traité (hêtre) + 2 plateaux inox GN1/1 + 4 accus + 4 pieds (cloches non incluses)

	cm	cm	€
11541 5	60 x 41	36	329,00

verchromte Stäbe  
 chrome plated fittings  
 pies cromados  
 pieds chromés

**passendes Zubehör / suitable accessories / accesorios a juego / accessoires assortis**

Rolltop-Haube GN1/1, vergoldeter Griff / rolltop cover, gold plated handle  
 campana rolltop, pomo dorado / cloche rolltop, bouton doré

11008 3	53,0 x 32,5	19	59,90
---------	-------------	----	-------

Rolltop-Haube GN1/1, verchromter Griff / rolltop cover, chrome plated handle  
 campana rolltop, pomo cromado / cloche rolltop, bouton chromé

11010 6	53,0 x 32,5	19	59,90
---------	-------------	----	-------

Kühlakku / cooler / acumulador de frío / accumulateur de froid

10779 3	25 x 19	2,5	7,40
---------	---------	-----	------



**Kühl-Akkus halten Ihre Speisen bis zu 6 Stunden kühl**

10779



**Buche (wasserfest lackiert)**



**Kühl-Akkus halten  
Ihre Speisen bis  
zu 6 Stunden kühl**

**Kühltablett „TOP FRESH RUND“  
Refrigerated buffet display  
expositor bufé frío redondo  
présentoir buffet**



3-teilig: 1 Holzbox mit Kunststoffwanne + 1 Edelstahl-Tablett Ø 38 cm + 1 Kühlakku  
3 pcs. set: 1 woodbox with plastic insert + 1 stainless tray Ø 38 cm + 1 cooler  
set de 3 piezas: 1 caja madera + 1 bandeja inox Ø 38 cm + 1 acumulador de frío  
set de 3 pièces: 1 base bois + 1 plateau inox Ø 38 cm + 1 accumulateur de froid

	□ cm	↑ cm	€
11542 2	Ø 48	6	174,00

**passendes Zubehör / suitable accessories / accesorios a juego / accessoires assortis**

Rolltop-Haube mit verchromtem Kugelgriff / rolltop cover with chrome plated handle  
campana abatible con pomo cromado / cloche basculante avec bouton chromé

18388 9	Ø 38	20	19,40
---------	------	----	-------

Rolltop-Haube mit vergoldetem Kugelgriff / rolltop cover gold plated handle  
campana abatible pomo dorado / cloche basculante bouton doré

18387 2	Ø 38	20	19,40
---------	------	----	-------

Kühlakku / cooler / acumulador de frío / accumulateur de froid

10779 3	25 x 19	2,5	7,40
---------	---------	-----	------



11543



**Kühl-Akkus halten  
Ihre Speisen bis  
zu 6 Stunden kühl**

**Kühltablett Buffet-Vitrine „DOPPELDECKER“  
Double refrigerated buffet display  
expositor de bufé redondo doble  
présentoir buffet froid, double**



11-teilig: 2 Rahmen Buchen-Holz versiegelt + 2 Edelstahl-Tablets Ø 38 cm  
+ 2 Kühlakkus + 2 Kunststoffschalen + 3 Stangen, ohne Hauben

11 pcs. set: 2 beech wood boxes waterproof + 2 stainless trays Ø 38 cm + 2 cooler + 2 plastic deep trays + 3 fittings, without covers

set de 11 piezas: 2 bases madera + 2 bandejas inox aprox. 38cm + 2 acumuladores + 2 cubetas plástico + 3 varas (campanas no incl.)

set de 11 pièces: 2 caissons bois traité (hêtre) + 2 plateaux inox approx. 38 cm + 2 accus + 2 bacs plastique + 3 barres (cloches non incluses)

	□ cm	↑ cm	€
11543 9	Ø 48	38	289,00
			verchromte Stäbe gold plated fittings varas doradas barres dorées

**passendes Zubehör / suitable accessories / accesorios a juego / accessoires assortis**

Rolltop-Haube mit verchromtem Kugelgriff / rolltop cover with chrome plated handle  
campana abatible con pomo cromado / cloche basculante avec bouton chromé

18388 9	Ø 38	20	19,40
---------	------	----	-------

Rolltop-Haube mit vergoldetem Kugelgriff / rolltop cover gold plated handle  
campana abatible pomo dorado / cloche basculante bouton doré

18387 2	Ø 38	20	19,40
---------	------	----	-------

Kühlakku / cooler / acumulador de frío / accumulateur de froid

10779 3	25 x 19	2,5	7,40
---------	---------	-----	------



**Kühltablett Buffet-Vitrine „TOP FRESH GN1/1“**  
**Cooling buffet display**  
**expositor bufé frío**  
**Présentoir buffet**



5-teilig: 1 Edelstahl-Tablett GN1/1 + 2 Kühlakkus + 1 Edelstahl-Schale + 1 Acrylrahmen, ohne Haube

5 pcs. set: 1 stainless tray GN1/1 + 2 cooler + 1 stainless deep tray + 1 frame acrylic, without cover

set de 5 piezas: 1 bandeja inox GN1/1 + 2 acumuladores + 1 cubeta inox + 1 marco metacrilato (campana no incl.)

set de 5 pièces: 1 plateau inox GN1/1 + 2 accus. de froid + 1 bac inox + 1 cadre plexi (cloche non-incl.)

	cm	cm	€
11510 1	61 x 38	8	210,00

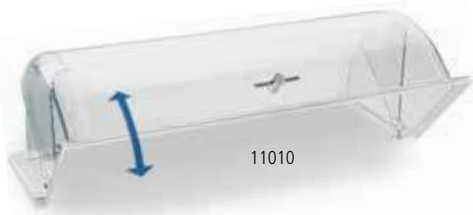

**passendes Zubehör / suitable accessories / accesorios a juego / accessoires assortis**

Rolltop-Haube GN1/1, verchromter Griff / rolltop cover, chrome plated handle  
 campana rolltop, pomo cromado / cloche rolltop, bouton chromé

11010 6	53,0 x 32,5	19	59,90
---------	-------------	----	-------

Kühlakku / cooler / acumulador de frío / accumulateur de froid

10779 3	25 x 19	2,5	7,40
---------	---------	-----	------



**Kühl-Akkus halten  
Ihre Speisen bis  
zu 6 Stunden kühl**



**Kühltablett Buffet-Vitrine „DOPPELDECKER“**  
**cooling plate**  
**expositor bufé frío**  
**présentoir buffet**



14-teilig: 2 Edelstahl-Tabletts GN1/1 + 4 Kühlakkus + 2 Edelstahl-Schale + 2 Acrylrahmen + 4 verchromte Stangen, ohne Hauben

14 pcs. set: 2 stainless tray GN1/1 + 4 cooler + 2 stainless deep trays + 2 frames acrylic + 4 chrome plated fittings, without covers

set de 14 piezas: 2 bandejas inox GN1/1 + 4 acum. de frío 2 cubetas inox + 2 bases metacrilato + 4 varas cromadas (sin las campanas)

set de 14 pièces: 2 plateaux inox GN1/1 + 4 accus 2 bacs inox + 2 cadres plexi + 4 barres chromées (sans les cloches)

	cm	cm	€
11514 9	61 x 38	33	379,00

**passendes Zubehör / suitable accessories / accesorios a juego / accessoires assortis**

Rolltop-Haube GN1/1, verchromter Griff / rolltop cover, chrome plated handle  
 campana rolltop, pomo cromado / cloche rolltop, bouton chromé

11010 6	53,0 x 32,5	19	59,90
---------	-------------	----	-------

Kühlakku / cooler / acumulador de frío / accumulateur de froid

10779 3	25 x 19	2,5	7,40
---------	---------	-----	------



**Kühl-Akkus halten  
Ihre Speisen bis  
zu 6 Stunden kühl**



11512

**Kühltablett „TOP FRESH RUND“**  
cooling plate  
expositor bufé frío  
présentoir buffet



4-teilig: 1 Edelstahl-Tablett Ø 38 cm + 2 Kühlakkus + 1 Edelstahl-Schale + 1 Acrylrahmen, ohne Haube

4 pcs. set: 1 stainless tray Ø 38 cm + 2 cooler + 1 stainless deep tray + 1 frame acrylic, without cover

set de 4 piezas: 1 bandeja inox 38cm + 2 acum. de frío + 1 cubeta inox + 1 base metacrilato (campana no incluida)

set de 4 pièces: 1 plateau inox 38cm + 2 accum. de froid + 1 bac inox + 1 base plexi (cloche non incl.)

	□ cm	↑ cm	€
11512 5	Ø 43,5	8	174,00



18388

**passendes Zubehör / suitable accessories / accesorios a juego / accessoires assortis**

Rolltop-Haube mit verchromtem Kugelgriff / rolltop cover with chrome plated handle  
campana abatible con pomo cromado / cloche basculante avec bouton chromé

18388 9	Ø 38	20	19,40
---------	------	----	-------

Kühlakku / cooler / acumulador de frío / accumulateur de froid

11101 1	16 x 7,5	2,0	4 pcs.	4,70
---------	----------	-----	--------	------

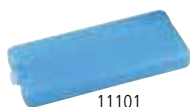

11101

**Kühl-Akkus halten Ihre Speisen bis zu 6 Stunden kühl**



11516

**Kühltablett Top Fresh „DOPPELDECKER“**  
cooling plate  
expositor de bufé doble redondo  
présentoir buffet



13-teilig: 2 Edelstahl-Tablets Ø 38 cm + 4 Kühlakkus + 2 Edelstahl-Schalen + 2 Acrylrahmen + 3 verchromte Stangen, ohne Hauben

13 pcs. set: 2 stainless trays Ø 38 cm + 4 cooler + 2 stainless deep tray + 2 frames acrylic + 3 chrome plated fittings, without covers

set de 13 piezas: 2 bandejas inox 38 cm + 4 acumuladores de frío + 3 varas cromadas + 2 bases + 2 bandejas, campana no incluida.

set de 13 pièces: 2 plateaux inox 38cm + 4 accum. de froid + 2 bacs inox + 2 bases plexi + 3 barres chromées (cloche non incl.)

	□ cm	↑ cm	€
11516 3	33 x 19,5	33	324,00

**passendes Zubehör / suitable accessories / accesorios a juego / accessoires assortis**

Rolltop-Haube mit verchromtem Kugelgriff / rolltop cover with chrome plated handle  
campana abatible con pomo cromado / cloche basculante avec bouton chromé

18388 9	Ø 38	20	19,40
---------	------	----	-------

Kühlakku / cooler / acumulador de frío / accumulateur de froid

11101 1	16 x 7,5	2,0	4 pcs.	4,70
---------	----------	-----	--------	------

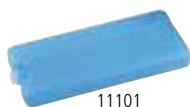

11101

**Kühl-Akkus halten Ihre Speisen bis zu 6 Stunden kühl**



11503  
Set, 4-teilig,  
weiß-transparent



11505  
Set, 4-teilig,  
schwarz



separates Zubehör:  
11100  
Tablett

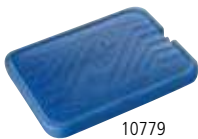

**Kühl-Akkus halten  
Ihre Speisen bis  
zu 6 Stunden kühl**

**Kühlbox „TOP FRESH GN1/1“  
cooling plate  
bandeja de frío  
présentoir buffet réfrigéré**



4-teilig: 1 Kühlbox + 1 Tablett GN1/1 + 2 Kühlakkus, ohne Haube

4 pcs. set: 1 box + 1 tray GN1/1 + 2 coolers, without cover

set de 4 piezas: 1 caja plástico blanco + 1 bandeja GN 1/1 + 2 acum. de frío, campana no incluida

set de 4 pièces: 1 caisson plastique blanc + 1 plateau GN 1/1 + 2 accum. de froid (cloche non incl.)

	cm	cm		€
11503 3	56,5 x 35	6,5	○	94,00
11505 7	56,5 x 35	6,5	●	94,00

**passendes Zubehör / suitable accessories  
accesorios a juego / accessoires assortis**



Rolltop-Haube GN1/1, vergoldeter Griff / rolltop cover, gold plated handle  
campana rolltop, pomo dorado / cloche rolltop, bouton doré

11008 3	53,0 x 32,5	19		59,90
---------	-------------	----	--	-------

Rolltop-Haube GN1/1, verchromter Griff / rolltop cover, chrome plated handle  
campana rolltop, pomo cromado / cloche rolltop, bouton chromé

11010 6	53,0 x 32,5	19		59,90
---------	-------------	----	--	-------

Kühlakku / cooler / acumulador de frío / accumulateur de froid

10779 3	25 x 19	2,5		7,40
---------	---------	-----	--	------

Edelstahl-Tablett „PROFI LINE“ / tray / bandeja / plat empilable système catering

	cm	cm	GN	€
11100 4	53,0 x 32,5	1,5	1/1	27,00

**In der Box sorgt der Kühlakku  
für eine beständige Frische  
für Wurst, Käse, etc.**



**Kühl-Akkus halten  
Ihre Speisen bis  
zu 6 Stunden kühl**

**Kühlbox „TOP FRESH“  
cooling box  
expositor buffet frío  
présentoir buffet**



4-teilig: 1 Kühlbox + Tablett GN1/1 + 2 Kühlakkus, ohne Haube

4 pcs. set: 1 box + 1 tray GN1/1 + 2 cooler, without rolltop cover

set de 4 piezas: 1 cajón + 1 bandeja GN 1/1 + 2 enfriadores, campana no incluida

set de 4 pièces: 1 caisson inférieur + 1 plateau GN 1/1 + 2 accus, cloche non incluse

	cm	cm		€
11590 3	56,5 x 36	8,5		220,00

**passendes Zubehör / suitable accessories / accesorios a juego / accessoires assortis**

Rolltop-Haube GN1/1, vergoldeter Griff / rolltop cover, gold plated handle  
campana rolltop, pomo dorado / cloche rolltop, bouton doré

11008 3	53,0 x 32,5	19		59,90
---------	-------------	----	--	-------

Rolltop-Haube GN1/1, verchromter Griff / rolltop cover, chrome plated handle  
campana rolltop, pomo cromado / cloche rolltop, bouton chromé

11010 6	53,0 x 32,5	19		59,90
---------	-------------	----	--	-------

Schneidbrett / chopping board / tabla de corte / planche à découper

00901 1	47,5 x 26,5	1		27,50
---------	-------------	---	--	-------

Kühlakku / cooler / acumulador de frío / accumulateur de froid

10779 3	25 x 19	2,5		7,40
---------	---------	-----	--	------





weiß-  
transparent  
oder schwarz

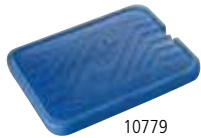

10779

**Kühl-Akkus halten  
Ihre Speisen bis  
zu 6 Stunden kühl**

**Kühlbox „TOP FRESH SET“  
cooling plate  
bandeja de frío  
set réfrigère**



3-teilig: 1 Box + 1 Tablett Ø 38 cm + 1 Kühlakku, ohne Haube  
3 pcs. set: 1 box + 1 tray Ø 38 cm + 1 cooler, without cover  
set de 3 piezas: 1 caja + 1 bandeja Ø 38 cm + 1 enfriador, sin tapa  
set de 3 pièces: 1 caisson + 1 plateau Ø 38 cm + 1 accum. (livré sans la cloche)

	□ cm	↑ cm		€
11538 5	Ø 42	6	○	77,00
11533 0	Ø 42	6	●	77,00

**passendes Zubehör / suitable accessories  
accesorios a juego / accessoires assortis**



Rolltop-Haube mit verchromtem Kugelgriff / rolltop cover with chrome plated handle  
campana abatible con pomo cromado / cloche basculante avec bouton chromé

18388 9	Ø 38	20		19,40
---------	------	----	--	-------



11101

**Kühl-Akkus halten  
Ihre Speisen bis  
zu 6 Stunden kühl**

**Thermo-Set  
thermo-set  
bandeja isotérmica  
set thermo**



5-teilig: 1 Tablett tief + 1 Tablett flach + 2 Kühlakkus + 1 Rolltop-Haube  
5 pcs. set: 1 deep tray + 1 tray + 2 cooler + 1 rolltop cover  
set de 5 piezas: 1 bandeja inferior + 1 bandeja + 2 acumuladores frío + campana  
set de 5 pièces: 1 plateau creux + 1 plateau plat + 2 accum. + 1 cloche rolltop

	□ cm	↑ cm		€
09082 8	Ø 38	24		50,00

**passendes Zubehör / suitable accessories  
accesorios a juego / accessoires assortis**



Rolltop-Haube mit verchromtem Kugelgriff / rolltop cover with chrome plated handle  
campana abatible con pomo cromado / cloche basculante avec bouton chromé

18388 9	Ø 38	20		19,40
---------	------	----	--	-------

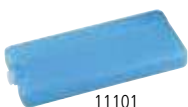

11101

**Kühl-Akkus halten  
Ihre Speisen bis  
zu 6 Stunden kühl**

**Thermo-Set  
thermo-set  
porta tartas refrigerado  
porte-gâteau réfrigéré**



4-teilig: 1 Tablett tief auf Fuß + 1 Tablett flach + 2 Kühlakkus  
4 pcs. set: 1 deep tray with feet + 1 tray + 2 cooler  
set de 4 piezas: 1 bandeja honda con pie + 1 bandeja + 2 acumuladores de frío  
set de 4 pièces: 1 plateau creux avec pied + 1 plateau plat + 2 accum.

	□ cm	↑ cm		€
09083 5	Ø 38	14,5		50,00

**passendes Zubehör / suitable accessories  
accesorios a juego / accessoires assortis**



Rolltop-Haube mit verchromtem Kugelgriff / rolltop cover with chrome plated handle  
campana abatible con pomo cromado / cloche basculante avec bouton chromé

18388 9	Ø 38	20		19,40
---------	------	----	--	-------



**Kühlschale, 2-teilig „COOL“**  
**cool bowl, 2 pcs. set**  
**bol refrigerado, 2 pz.**  
**set de 2 bols réfrigérés**



2-teilig, doppelwandig, Schale ist mit Kühlmittel gefüllt und wird zum Aufladen in das Gefrierfach gelegt, endlos verwendbar

2 pcs., 1 pc. double wall ice bowl filled with freezer-liquid, 1 pc. stainless bowl

bol isotérmico, doble pared que contiene un líquido refrigerante, acumula el frío en el congelador para luego mantener fríos los alimentos, para usos repetitivos

bol isotherme, double paroi qui contient un liquide réfrigérant, accumule le froid du congélateur pour ensuite maintenir froids les aliments, pour usages répétés



	□ cm	↑ cm	ltr.	€
30023 1	Ø 23	10,5	1	42,00

**Einzelteile / spare parts / piezas sueltas / pièces détachées**

Deckel „FLOAT“, mit Löffelaussparung / cover, with notched for spoons / tapa, con espacio para la cuchara / couvercle, avec encoche pour la louche

83920 5	Ø 20,5	1,3		8,20
---------	--------	-----	--	------



**Kühldauer bis zu 3 Stunden**

**Kühlschale Maxi Holz „TOP FRESH“**  
**cool maxi holz**  
**bol refrigerado MAXI madera**  
**bol réfrigéré MAXI bois**



11817  
2,5 ltr.

4-teilig: 1 Fuß Buchen-Holz versiegelt + 1 Schale + 1 Kühlakku + 1 klappbarer Deckel mit Beschriftungsschild

4 pcs. set: 1 column with food base (beech) + 1 bowl + 1 cooler + 1 cover with card, hinged

set de 4 piezas: 1 bol + 1 base madera + 1 acumulador de frío + 1 tapa con bisagra y porta etiqueta

	□ cm	↑ cm	ltr.	€
11817 1	Ø 22	14	2,5	94,00
11818 8	Ø 22	18	4	102,00

**Einzelteile / spare parts / piezas sueltas / pièces détachées**

Ersatzschale für 11817 / spare bowl for 11817  
 recambio bol para 11817 / bol de rechange pour 11817

11846 1	Ø 22	8		35,00
---------	------	---	--	-------

Ersatzschale für 11818 / spare bowl for 11818  
 recambio bol para 11818 / bol de rechange pour 11818

11848 5	Ø 22	12		44,80
---------	------	----	--	-------

Ersatzdeckel für 11817 + 11818 / replacement cover for 11817 + 11818  
 tapa de recambio para 11817 + 11818 / couvercle de rechange pour 11817 + 11818

11878 2	Ø 23,5			11,40
---------	--------	--	--	-------

Kühlakku / cooler / acumulador de frío / accumulateur de froid

10777 9	Ø 15	2,5		5,00
---------	------	-----	--	------



11818  
4 ltr.



**Kühl-Akkus halten Ihre Speisen bis zu 6 Stunden kühl**

10777



11810  
0,6 ltr.



11815  
1 ltr.



**Kühl-Akkus halten  
Ihre Speisen bis  
zu 6 Stunden kühl**

10777

**Kühlschale Mini „TOP FRESH“  
cool bowl mini  
bol refrigerado MINI  
bol réfrigéré MINI**



4-teilig: 1 Edelstahlgefäß matt + 1 Kühlakku + 1 Schale + 1 klappbarer Deckel mit Beschriftungsschild

4 pcs. set: 1 column satin polished finish + 1 cooler + 1 bowl + 1 cover with card, hinged  
set de 4 piezas: 1 base acabado efecto satinado + 1 acumulador de frío + 1 tapa con porta etiqueta + 1 bol

set de 4 pièces: 1 base inox mat satiné + 1 accum. de froid + 1 couvercle à charnière avec porte étiquette + 1 bol

	□ cm	↑ cm	ltr.	€
11810 2	Ø 14	9	0,6	42,00
11815 7	Ø 14	11,5	1	44,00

**Einzelteile / spare parts / piezas sueltas / pièces détachées**

Ersatzschale / spare bowl / recambio bol / bol de rechange

11811 9	Ø 14	6,5		15,40
11816 4	Ø 14	9		21,40

Ersatzdeckel für 11810 + 11815 / replacement cover for 11810 + 11815  
tapa de recambio para 11810 + 11815 / couvercle de rechange pour 11810 + 11815

11868 3	Ø 14,5			10,40
---------	--------	--	--	-------

Kühlakku / cooler / acumulador de frío / accumulateur de froid

10661 1	Ø 10,5	2,0		3,20
---------	--------	-----	--	------



11812  
0,6 ltr.



11813  
1 ltr.



**Kühl-Akkus halten  
Ihre Speisen bis  
zu 6 Stunden kühl**

10661

**Kühlschale Mini Holz „TOP FRESH“  
cool bowl mini holz  
bol refrigerado mini madera  
bol réfrigéré MINI bois**



4-teilig: 1 Fuß Buchen-Holz versiegelt + 1 Schale + 1 Kühlakku + 1 klappbarer Deckel mit Beschriftungsschild

4 pcs. set: 1 column with food base (beech) + 1 bowl + 1 cooler + 1 cover with card, hinged  
set de 4 piezas: 1 bol policarbonato + 1 base madera + 1 acum. de frío + 1 tapa con bisagra y porta etiqueta

set de 4 pièces: 1 base en bois + 1 accum + 1 bol polycarbonate + 1 couvercle à charnière avec porte-étiquette

	□ cm	↑ cm	ltr.	€
11812 6	Ø 14	9	0,6	39,00
11813 3	Ø 14	11,5	1	41,00

**Einzelteile / spare parts / piezas sueltas / pièces détachées**

Ersatzschale / spare bowl / recambio bol / bol de rechange

11811 9	Ø 14	6,5		15,40
11816 4	Ø 14	9		21,40

Ersatzdeckel für 11812 + 11813 / replacement cover for 11812 + 11813  
tapa de recambio para 11812 + 11813 / couvercle de rechange pour 11812 + 11813

11868 3	Ø 14,5			10,40
---------	--------	--	--	-------

Kühlakku / cooler / acumulador de frío / accumulateur de froid

10661 1	Ø 10,5	2,0		3,20
---------	--------	-----	--	------



2,5 ltr.



10777

**Kühl-Akkus halten  
Ihre Speisen bis  
zu 6 Stunden kühl**

**Kühlschale Maxi „TOP FRESH“  
cool bowl maxi  
bol refrigerado MAXI  
bol réfrigéré MAXI**



4-teilig: 1 Gefäß hochglanzpoliert + 1 Kühlakku + 1 Glasschale + 1 klappbarer Deckel mit Beschriftungsschild

4 pcs. set: 1 column mirror polished finish + 1 cooler + 1 glass bowl + 1 cover with card, hinged

set de 4 piezas: 1 base pulido acabado efecto espejo + 1 acumulador de frío + 1 tapa con porta etiqueta + 1 bol vidrio

set de 4 pièces : 1 base inox poli brillant + 1 accum. + 1 bol verre + 1 couvercle à charnière avec porte-étiquette

	cm	cm	ltr.	€
11845 4	Ø 23	14	2,5	76,00

Ersatzdeckel / replacement cover  
tapa de recambio / couvercle de rechange

11878 2	Ø 23,5			11,40
---------	--------	--	--	-------

Schale / bowl / cuenco / bol

11875 1	Ø 23	10,5		4,20
---------	------	------	--	------

Kühlakku / cooler / acumulador de frío / accumulateur de froid

10777 9	Ø 15	2,5		5,00
---------	------	-----	--	------



11847  
2,5 ltr.

**Kühlschale Maxi „TOP FRESH“  
cool bowl maxi  
bol refrigerado MAXI  
bol réfrigéré MAXI**



4-teilig: 1 Gefäß hochglanzpoliert + 1 Kühlakku + 1 Schale + 1 klappbarer Deckel mit Beschriftungsschild

4 pcs. set: 1 column mirror polished finish + 1 cooler + 1 bowl + 1 cover with card, hinged

set de 4 piezas: 1 base pulido acabado efecto espejo + 1 acumulador de frío + 1 tapa con porta etiqueta + 1 bol

set de 4 pièces : 1 base inox poli brillant + 1 accum. + 1 récipient + 1 couvercle à charnière avec porte-étiquette

	cm	cm	ltr.	€
11847 8	Ø 22	14	2,5	98,00
11849 2	Ø 22	18	4	102,00

**Einzelteile / spare parts / piezas sueltas / pièces détachées**

Ersatzschale / spare bowl / recambio bol / bol de rechange

11846 1	Ø 22	8		35,00
11848 5	Ø 22	12		44,80

Ersatzdeckel für 11847 + 11849 / replacement cover for 11847 + 11849  
tapa de recambio para 11847 + 11849 / couvercle de rechange pour 11847 + 11849

11878 2	Ø 23,5			11,40
---------	--------	--	--	-------

Kühlakku / cooler / acumulador de frío / accumulateur de froid

10777 9	Ø 15	2,5		5,00
---------	------	-----	--	------



11849  
4 ltr.



10777

**Kühl-Akkus halten  
Ihre Speisen bis  
zu 6 Stunden kühl**

**Serviergestell**  
**servicing stand**  
**expositor**  
**présentoir**



	□ cm	↑ cm	cm	€
33245 4	Ø 48	49	4 x Ø 20	74,00
33246 1	Ø 22	59	12 x Ø 6	85,00
33247 8	Ø 22	33	6 x Ø 6	54,00



passend für 12 Weck-Gläser Ø 6 cm  
 Nr. 82310, 82312, 82314



passend für Schalen Ø 20 cm Nr. 83704, 83705  
 und für Körbe Ø 20 cm Nr. 50605, 50606, 50607



passend für 6 Weck-Gläser Ø 6 cm  
 Nr. 82310, 82312, 82314

Buffet . Banquet  
 buffet . banquet



**Buffet-Gestell für Körbe**  
**buffet stand for baskets**  
**expositor para cestas**  
**support métal pour corbeilles**



2-stufig, für 2 rechteckige Körbe, platzsparend zusammenklappbar, Lieferung ohne Körbe  
 2-tier, for 2 rectangular baskets, can be folded, place saving, delivery without baskets  
 2 alturas, para 2 cestas rectangulares, totalmente plegable para ahorrar espacio, se entrega sin cestas  
 2 hauteurs, pour 2 corbeilles rectangulaires, pliable pour son rangement, livré sans corbeilles

40222  
Korb

	□ cm	↑ cm	€
33221 8	46 x 24	18 - 21	39,00



**Einzelteile / spare parts / piezas sueltas / pièces détachées**

Tisch- und Buffet-Korb rechteckig „BASIC“ / buffet basket / cesta de bufé / corbeille de buffet

30286 0	30,0 x 22,0	7	●	3,60
30288 4	41,0 x 29,0	7	●	7,00
40154 9	30,0 x 24,5	8	●	9,00
40159 4	31,5 x 22,0	8,5	●	6,00
40161 7	50,0 x 25,0	6	●	14,00
40222 5	32,5 x 26,5	6,5	●	10,00
40242 3	32,5 x 26,5	10	●	13,40
40262 1	32,5 x 26,5	6,5	●	10,40
40272 0	32,5 x 26,5	10	●	13,40



## Buffet-Gestell „DOPPELDECKER“

buffet frame  
estructura para bufé  
support buffet



**in 2 Größen  
erhältlich und  
vielseitig  
erweiterbar**

11555  
Buffet-Gestell GN1/1

11553  
Buffet-Gestell GN 1/2

für GN, 2-teilig, einfach zusammensetzbar, Etagen-Abstand ca. 26 cm, platzsparend, stabile Ausführung

for GN, 2 pcs. frame, easy to assemble, distance between the tiers approx 26 cm, space-saving, robust

para bandejas GN, 2 piezas, fácil de montar, distancia entre pisos aprox. 26 cm, robusto  
pour corbeilles ou plats GN, 2 étages, distance entre niveaux approx. 26 cm, robuste

	□ cm	↑ cm	GN	€
11555 2	50 x 34	37,5	1/1	59,00
11553 8	29 x 27	35	1/2	44,00

GN1/2



40154  
Korb

Buffet-Korb GN „ECONOMIC“ / GN basket / cesta GN / corbeille GN

40148 8	53,0 x 32,5	8	1/1	●	24,00
40154 9	30,0 x 24,5	8		●	9,00



11017  
Haube  
GN1/1

Edelstahl-Tablett „PROFI LINE“ / tray / bandeja / plat empilable système catering

11100 4	53,0 x 32,5	1,5	1/1		27,00
---------	-------------	-----	-----	--	-------

Abdeckhaube GN / cover GN / cubierta GN / cloche GN

11001 4	32,5 x 26,5	9,5	1/2		19,00
11008 3	53,0 x 32,5	19	1/1		59,90
11010 6	53,0 x 32,5	19	1/1		59,90

Kuppelhaube für GN1/1, glasklarer Kunststoff, Chromgriff, geschlossen

cover, clear, chrome knob, totally closed

cúpula, transparente, asa cromada, cerrada

cloche bombée, transparente, anse chromée, totalement fermée

11015 1	54 x 33	20			51,00
---------	---------	----	--	--	-------

GN1/1



11017  
Haube  
GN1/1

Kuppelhaube für GN1/1, glasklarer Kunststoff, Chromgriff, mit Front-Ausschnitt

cover, clear, chrome knob, one long side cut out

cúpula, transparente, asa cromada, gran apertura frontal

cloche bombée, transparente, anse chromée, grande ouverture frontale

11017 5	54 x 33	20			56,00
---------	---------	----	--	--	-------

Kuppelhaube für GN1/1, glasklarer Kunststoff, Chromgriff, mit seidl. Ausschnitt

cover, clear, chrome knob, one small side cut out

cúpula, transparente, asa cromada, pequeña apertura frontal

cloche bombée, transparente, anse chromée, petite ouverture frontale

11019 9	54 x 33	20			56,00
---------	---------	----	--	--	-------



40148  
Korb GN1/1



in 2 Höhen erhältlich

**Brötchen-Spender „INOX“**  
roll dispenser  
dispensador de panecillos  
distributeur de petits pains



hygienisch und einfach zu reinigen, mit Krümelschale  
hygienic and easy to clean, with crumb tray  
higiénico y fácil de limpiar, con bandeja para migas  
hygiénique et facile à laver, avec plat ramasse-miettes

	□ cm	↑ cm		€
11572 9	32,5 x 27,5	42	für ca. 45 - 50 Brötchen for approx. 45 - 50 rolls para 45-50 panecillos pour 45-50 petits pains	194,00
11573 6	32,5 x 27,5	56	für ca. 65 - 70 Brötchen for approx. 65 - 70 rolls para 65-70 panecillos pour 65-70 petits pains	219,00

**Einzelteile / spare parts / piezas sueltas / pièces détachées**

Deckel / cover / tapa / couvercle seul

11562 0	32 x 27	1		18,40
---------	---------	---	--	-------



**Hygieneschutz**  
hygienic cover  
cubierta higiénica antialiento  
pare-haleine



	□ cm	↑ cm		€
11556 9	82 x 42	45		180,00



GN1/1

GN1/1

# BROTSTATION



mit Antirutsch-Füßchen  
non-slip feet  
con pies antideslizantes  
avec pieds antidérapants

## Tablett „BROTSTATION“ tray bandeja plateau

Antirutsch-Füßchen  
non-slip feet  
pies antideslizantes  
pieds antiglisse



	cm	cm	€
83615 0	59,5 x 35,5	3,5	37,00



00953  
Schneidebrett

83615  
Tablett

## Brotschneidebrett „BROTSTATION“ cutting board tabla de corte planche à découper

Buchen-Holz  
beech  
haya  
hêtre



	cm	cm	€
00953 0	52 x 34	2	33,00



00954  
Box

00959  
Box

83615  
Tablett

## Box „BROTSTATION“ box caja de pan para el bufé boîte à pain pour le buffet

Buchen-Holz  
beech  
haya  
hêtre



	cm	cm	€
00959 2	34 x 26	12,5	50,00
00954 7	34 x 26	20,0	56,00



**NEW****Holz/wood  
Akazie**
**Brotschneidebrett „AKAZIA“  
cutting board  
tabla para cortar  
planche à découper**

mit herausnehmbarem Krümfach, auf 4 Antirutschfüßchen, Akazienholz  
with bread crump shelf, anti slip-feet, wood akazia  
tabla para cortar pan, madera tratada antideslizante  
planche à pain, bois traité antidérapant

	☐ cm	↑ cm	GN	€
00883 0	47,5 x 32,0	2	-	25,80
00884 7	53,0 x 32,5	2	1/1	26,40
00885 4	60,0 x 40,0	2	-	32,00

**praktisches  
Krümfach**
**Brotschneidebrett „RUBBERWOOD“  
cutting board  
tabla para cortar  
planche à découper**

mit herausnehmbarem Krümfach, auf 4 Antirutschfüßchen  
with bread crump shelf, anti slip-feet  
tabla para cortar pan, madera tratada antideslizante  
planche à pain, bois traité antidérapant

	☐ cm	↑ cm	GN	€
00955 4	47,5 x 32	2	-	24,00
00956 1	53 x 32,5	2	1/1	25,00
00957 8	60 x 40	2	-	29,00

**Brotschneidebrett, 2-tlg.  
cutting board, 2 pcs.  
tabla para cortar, 2 piezas  
planche à découper, 2 pièces**

2-tlg. Set, GN1/1 Behälter, 20 mm tief, dient als Krümfach  
2 pcs. set, GN1/1 pan 20 mm, bread crump shelf  
set de 2 piezas: tabla de corte + bandeja inox GN 1/1 alt 20 mm (sirve para recoger las migas)  
set de 2 pièces: planche à découper bois + plateau inox GN 1/1 Ht 20 mm (sert de ramasse-miettes)

	☐ cm	GN	€
00951 6	53 x 32,5	1/1	33,00

**Einzelteile / spare parts / piezas sueltas / pièces détachées**

einzelnes Brett / separate board / tabla por separado / planche seule

00952 3	53 x 32,5	1/1	17,00
---------	-----------	-----	-------

**Brotschneidebrett, 2-tlg.  
satin polished finish, cutting board, 2pcs.  
tabla para cortar pan, 2 piezas, laterales mates  
planche à découper, 2 pièces, bords métal mat**

matt poliert, Krümel-Tablett, auf 4 Antirutschfüßchen  
crumb tray, anti slip-feet  
madera tratada, pies antideslizantes  
bois traité, pieds antidérapants

	☐ cm	↑ cm	€
00950 9	48 x 32	2	49,00



**NEW**



84531

**Schale "MULTI"  
bowl  
cuenco  
bol**

inklusive 3 herausnehmbare Trennwände, 4 Kammern  
including 3 removable divider, 4 chambers  
con 3 divisores extraíbles, 4 compartimentos  
avec 3 parois de séparation amovibles, 4 compartiments

	cm	cm	litr.		€
84531 2	31,5 x 17,5	7	2,1	○ white	19,00
84532 9	31,5 x 17,5	7	2,1	● anthrazit	19,00

**Einzelteile / spare parts / piezas sueltas / pièces détachées**

Trenner, 6er Set / divider, 6 pcs. / divisor, 6 pz. / paroi de séparation, 6 pc.

	cm	mm		€
84533 6	16,5 x 5	3,5	○ white	6,90
84534 3	16,5 x 5	3,5	● anthrazit	6,90



84532



**stapelbar**

↑ Front-  
klappe

○ 11884

● 11885

**Universalbox  
box / sweetbox  
caja dispensadora  
boîte distributrice**



ideal als Verkaufsbox, mit Frontdeckel  
best to present sweets etc., all-purpose, with front lid  
la perfecta solución para presentar golosinas, universal, con tapa frontal  
la solution idéale pour les friandises et autres, universel, avec couvercle frontal

	cm	cm		€
11884 3	23 x 14,5	15	○ weiß / white	11,00
11885 0	23 x 14,5	15	● rot / red	11,00

**Vorratsdose  
canister with spoon  
bote con cuchara  
pot en verre avec cuillère**



inkl. Löffel

Glaskugel mit Löffel, Schraubdeckel mit aromadichtem Verschluss, Edelstahl-Löffel mit magnetischem Silikongriff, 1 Stck.  
tight cover, stainless steel spoon with magnetic silicone handle, 1 pc.  
acero inoxidable, tapa de vidrio ajustable, cuchara inox con mango magnético de silicona, 1 pc.  
pot en verre avec cuillère avec manche aimanté revêtu de silicone, couvercle à visser pour conserver les arômes, 1 pz.

	cm	cm	litr.	€
00636 2	Ø 20	18	3	8,40

**HOT PRICE**



**Vorratsdose mit Deckel  
canister with lid  
contenedor con tapa  
pot en verre avec couvercle**



Glaskugel mit Schraubdeckel, aromadichtem Verschluss, 1 Stck.  
glass ball, aroma-tight screw cap, 1 pc.  
bola de cristal, tapa de rosca para conservar el aroma, 1 pz.  
boule de verre, bouchon à vis de l'arôme étanche, 1 pz.

	cm	cm	litr.	€
00637 9	12,5 x 19	18	1	6,40



4 Fächer

**Snackpresenter**  
**snackpresenter**  
**dispensador de bocadillos**  
**présentoir à sandwiches**



4 Mulden/Fächer  
 4 slots  
 para hasta 4 bocadillos  
 parfait jusqu'à 4 sandwiches

	cm	cm	€
11969 7	56 x 8	5,5	12,00



mit 7 Mulden

**Snackpresenter**  
**snackpresenter**  
**dispensador de bocadillos**  
**présentoir à sandwiches**



hochglanzpoliert, mit Griffmulde, für 7 Baguettes  
 mirror polished finish, with recessed grip, for 7 baguettes  
 inox pulido brillante, ideal para hasta 7 bocadillos  
 inox poli brillant, parfait jusque maxi 7 sandwiches

	cm	cm	€
11891 1	47,5 x 10,5	6	25,00



11887  
3 Mulden

**Snackpresenter**  
**snackpresenter**  
**dispensador de bocadillos**  
**présentoir à sandwiches**



mit Safrille und Griffmulde, passend für Vitrine 11888  
 with recessed grip, suitable for showcase 11888  
 asa moldeada, apto para la vitrina 11888  
 anse moulée, apte pour vitrine 11888

	cm	cm	€
11887 4	29 x 19	6,5	19,40
			3 Mulden 3 compartments 3 compartimentos 3 compartiments
11889 8	60 x 19	7,5	24,00
			6 Mulden 6 compartments 6 compartimentos 6 compartiments



11889  
6 Mulden



**Vitrine / Thekenaufsatz**  
**showcase**  
**vitrina de mostrador**  
**vitrine de comptoir**



rutschfest, aus einem Teil gefertigt  
 antislip, monoblock produced  
 plástico transparente, fabricado en 1 pieza  
 transparente, plastique monoblock (injecté)

	cm	cm	€
11888 1	63,5 x 25	25	82,00

**Getränke werden bis zu 4 Stunden gekühlt**



1,4 ltr.



**Ausgießer für tropffreies Servieren**



**Kühlstation inkl. Kühlakku (schwarz) Fuß, hochglanzverchromt**

**Kühlkaraffe, 3-teilig „COOL“  
cooling carafe, 3 pcs. set  
jarra fría, set de 3 piezas  
pichet rafraîchisseur, set 3 pièces**



1 Glaskaraffe mit Edelstahl-Ausgießer, öffnet und schließt selbstständig + 1 verchromter Fuß + 1 Kühlakku, Getränke werden bis zu 4 Stunden gekühlt

1 glass carafe with stainless steel pourer, open / closing autonomous + 1 chrome plated base + 1 cooling pack, up to 4 hours cooled beverages

1 botella de vidrio con vertedor inox y silicona, con autocierre + 1 base cromada + 1 placa de frio que mantiene las bebidas frescas hasta unas 4 horas

pichet en verre avec insert verseur inox et silicone, fermeture automatique + socle chromé + accumulateur de froid pour maintenir les boissons froides jusqu'à 4 heures

	□ cm	↑ cm	ltr.	€
10762 5	Ø 16	27	1,4	31,00

**Einzelteile / spare parts / piezas sueltas / pièces détachées**

Glasflasche / glass carafe / jarra de vidrio / pichet verre

10761 8	Ø 16	26		22,00
---------	------	----	--	-------

Kühlakku rund, schwarz / cooler round, black / cooler / accumulateur de froid, noir

10752 6	Ø 10,5			4,60
---------	--------	--	--	------



**Ausgießer für tropffreies Servieren**

**Temperaturbereich -10°C bis +110°C**

**Glas-Karaffe  
glass carafe  
jarra  
pichet verre**



Deckel aus Edelstahl

stainless steel cover

tapa de acero inoxidable

couvercle inox

	□ cm	↑ cm	ltr.	€
10764 9	Ø 9,5	27	1,5	22,50

**Glas-Karaffe  
glass carafe  
jarra  
pichet en verre**



der Deckel öffnet sich beim Ausgießen automatisch, Glas, Deckel aus Edelstahl, Silikon, hitzebeständig

cover opens automatically while pouring, stainless steel cover, glass, silicon, heat-resistant

la tapa se abre automáticamente durante el vertido, tapa de acero inoxidable, cristal, silicona, resistente al calor

le couvercle s'ouvre seul pendant le service, couvercle inox, corps en cristal, silicone, résistant à la chaleur



1 ltr.

	□ cm	↑ cm	ltr.	€
10766 3	Ø 9,5	29	1	19,00



1,8 ltr.

**Saftkanne**  
**juice pitcher**  
**jarra para zumo**  
**pichet à jus de fruit**



inklusive Stift (schwarz) zum Beschriften, Beschriftung lässt sich leicht entfernen (Kanne wird unbeschriftet geliefert)

marker (black) included, marking can be easily removed (pitcher is not marked)

rotulador incluido, fácil de borrar (se entrega sin ningún texto marcado)

marqueur inclus, facile à effacer (livraison sans texte écrit)

	□ cm	↑ cm	ltr.	€
10753 3	Ø 12	24	1,8	18,00
10787 8	Ersatzstift	Strickstärke 1 mm		3,00

NEW



2 ltr.

**Kanne**  
**pitcher**  
**jarra**  
**pichet**



mit transparentem Deckel, ideal für Milch

included transparent cover, perfect for milk

tapa transparente, perfecto para leche

couvercle transparent, pour lait

	□ cm	↑ cm	ltr.	€
84225 0	Ø 14	21	2	25,00



2 ltr.

**Kanne „ICEBLUE“**  
**pitcher**  
**jarra**  
**pichet**



mit transparentem Deckel

included transparent cover

tapa transparente

couvercle transparent

	□ cm	↑ cm	ltr.	€
10754 0	Ø 12	26	2	14,00

1,6 ltr.



10771

10772

10773

10774

**Karaffe / Kanne**  
**bottle**  
**botella**  
**bouteille**



Schraubdeckel mit aromadichtem Verschluss

screwed lid, aroma-tight

tapón de rosca, impide la fuga de aromas

bouchon à visser, ne laisse pas passer les arômes

	□ cm	↑ cm	ltr.	€
10771 7	Ø 11	30	1,6	12,90
10772 4	Ø 11	30	1,6	12,90
10773 1	Ø 11	30	1,6	12,90
10774 8	Ø 11	30	1,6	12,90



**Saft- / Wasserkanne**  
**juice / water pitcher**  
**jarra para zumo / agua**  
**pichet à eau ou jus de fruit**



mit Eiswasser-Röhre  
 with water ice tube  
 con tubo para hielo  
 avec tube à glaçons plongeant pour réfrigérer

	□ cm	↑ cm	ltr.	€
10769 4	19 x 13	27	2,4	20,00



3 ltr.

**Saftkanne**  
**juice pitcher**  
**jarra para zumo**  
**pichet à jus de fruit**



mit Eiswasser-Röhre  
 with water ice tube  
 con tubo para agua  
 avec tube à eau à congeler

	□ cm	↑ cm	ltr.	€
10770 0	Ø 18,0	29	3	23,00



2,5 ltr. 10776

2 ltr. 10775

**Saftkanne**  
**juice pitcher**  
**jarra para zumo**  
**pichet à jus de fruit**



	□ cm	↑ cm	ltr.	€
10776 2	Ø 14	29	2,5	15,40
10775 5	Ø 12	26	2	18,00



1,5 ltr.



**Pitcher „CLASSIC“**  
**pitcher**  
**jarra**  
**pichet**



	□ cm	↑ cm	ltr.	€
93105 3	Ø 13	21	1,5	8,40



**Saftkanne**  
**juice pitcher**  
**jarra para zumo**  
**pichet à jus**



mit Eiswasser-Röhre und Fruchtkammer, Inhalt mit Röhre 2,2 Liter  
 with water ice tube and fruit tube, capacity with tube 2,2 liters  
 con tubo para agua, capacidad con tubo 2,2 litros  
 avec tube à glaçons plongeant pour réfrigérer, capacité 2,2 litres avec le tube

	☐ cm	↑ cm	ltr.	€
10768 7	23 x 13	27	2,5	32,00



Buffet . Banquet  
 buffet . banquet



**Iso-Dispenser**  
**insulated dispenser**  
**dispensador isotérmico**  
**distributeur de boisson isothermique**



für heiße und kalte Getränke  
 for hot and cold drinks  
 para bebidas frías y calientes  
 pour boissons chaudes ou froides

	☐ cm	↑ cm	ltr.	€
10788 5	Ø 24	42	9,5	53,40

**Einzelteile / spare parts / piezas sueltas / pièces détachées**

Hahn / tap / grifo / robinet	€
10789 2	10,30



### Saftdispenser Kühlung

Kühlung von „oben und unten“. Zwei Kühllakkus halten Ihre Getränke lange kühl und frisch. Der Kühllakku im Deckel (Kälte „fällt“) und der Kühllakku in der Edelstahlsäule sind einfach einzulegen. Einfach und hygienisch! Empfohlen nach HACCP! 4 Liter- oder 6 Liter-Behälter.

### Juice dispenser cooling

Cooling from „the top and base“. Two cooling elements keep the juice cold and fresh. The cooler in the cover and the cooler in the base/column are easy to handle. Simple handling of the exclusive nontrip tap with lever - it shuts by itself. Simple cleaning, fattening is not necessary. 4 liters or 6 liters container.

### Dispensador de zumo enfriador

Enfria por abajo y por arriba. Los acumuladores de frío mantienen el zumo frío y fresco, y son fáciles de quitar y poner, tanto el elemento, de la tapa como el de la base. Muy sencillo e higiénico. Evita tener que usar hielo. Recomendado según HACCP. Capacidad: 4 o 6 litros.

### Distributeur à jus de fruits réfrigéré

Double réfrigération par le haut et par le bas, grâce à 2 accumulateurs de froid faciles à changer situés pour l'un dans le couvercle (le froid „tombe“) et pour l'autre sous le récipient. Simple et parfaitement hygiénique. Permet d'éviter l'usage de glaçons. Recommandé HACCP. Capacité 4 ou 6 litres.



### Saftdispenser „TOP FRESH“ juice dispenser dispensador de zumo distributeur à jus de fruit



hochglanzpoliert, Kühlung durch 2 Kühllakkus von oben und unten  
mirror polished finish, cooling with 2 cooling elements from the top and base  
base inox brillante, con 2 acum. de frío, 1 arriba y 1 en la base  
base inox poli brillant, 2 plaques de froid (1 dans le couvercle, 1 dans le socle)

	□ cm	↑ cm	ltr.	€
10800 4	21 x 32	43	4	229,00
10700 7	23 x 35	52	6	324,00



### Saftdispenser DUO „TOP FRESH“ juice dispenser dispensador de zumo distributeur à jus de fruit



hochglanzpoliert, Kühlung durch 2 Kühllakkus von oben und unten  
mirror polished finish, cooling with 2 cooling elements from the top and base  
acabado pulido brillante, 2 acum. de frío (1 en la base y 1 en la tapa)  
base inox poli brillant, 2 plaques de froid (1 dans le couvercle, 1 dans le socle)

	□ cm	↑ cm	ltr.	€
10720 5	42 x 32	52	2 x 6	479,00





4 ltr.  
10820

6 ltr.  
10730

**Saftdispenser WOOD „TOP FRESH“**  
juice dispenser  
dispensador de zumo  
distributeur à jus de fruit



Buchen-Holz versiegelt, Kühlung durch 2 Kühllakkus von oben und unten  
beech wood, waterproof, cooling with 2 cooling elements from the top and base  
madera de haya con tratamiento anti humedad, 2 acumuladores de frío (1 en la base y 1 en la tapa)  
bois de hêtre traité anti-humidité, 2 plaques de froid (1 dans le couvercle, 1 dans le socle)

	□ cm	↑ cm	ltr.	€
10820 2	21 x 31	44	4	250,00
10730 4	23 x 35	52	6	370,00



2 x 6  
ltr.

**Saftdispenser WOOD DUO „TOP FRESH“**  
juice dispenser  
dispensador de zumo  
distributeur à jus de fruit



Buchen-Holz versiegelt, Kühlung durch 2 Kühllakkus von oben und unten  
beech wood, waterproof, cooling with 2 cooling elements from the top and base  
madera de haya con tratamiento anti humedad, 2 acumuladores de frío (1 en la base y 1 en la tapa)  
bois de hêtre traité anti-humidité, 2 plaques de froid (1 dans le couvercle, 1 dans le socle)

	□ cm	↑ cm	ltr.	€
10740 3	42 x 35	52	2 x 6	579,00



6 + 5  
ltr.

**Saft- und Milchdispenser WOOD DUO „TOP FRESH“**  
juice and milk dispenser  
dispensador de zumo  
distributeur à jus de fruit



6 Liter Saftbehälter, 5 Liter Milchkanne, Kühlung durch 2 Kühllakkus von oben und unten,  
Buchen-Holz versiegelt  
6 liters juice container, 5 liters milkcan, cooling with 2 cooling elements from the top and base,  
beech wood, waterproof  
madera de haya con tratamiento anti humedad, 2 acumuladores de frío, enfriador en la base  
bois de hêtre traité anti-humidité, 2 accum. dans le socle

	□ cm	↑ cm	ltr.	€
10765 6	42 x 35	52	6 + 5	798,00

**Saftdispenser „SUNDAY“**  
**juice dispenser**  
**dispensador de zumo**  
**distributeur à jus de fruit**



6 ltr.

matt poliert, Kühlung durch 2 Kühlakkus von oben und unten  
 satin polished finish, cooling with 2 cooling elements from the top and base  
 acabado pulido brillante, 2 acum. de frío (1 en la base y 1 en la tapa)  
 inox mat, 2 accus. de froid (1 socle et 1 couvercle)

	cm	cm	ltr.	€
10860 8	21 x 35	48	6	264,00

**Einzelteile / spare parts / piezas sueltas / pièces détachées**

Saftbehälter transparent, ohne Zapfhahn / juice canister transparent, without tap  
 contenedor transparente sin grifo / récipient cylindrique sans le robinet

10806 6	Ø 22	26	6	106,00
---------	------	----	---	--------

Hahn / tap / grifo / robinet

10867 7				41,50
---------	--	--	--	-------

**Dispenser „SUNDAY“**  
**juice dispenser**  
**dispensador de zumo o leche**  
**distributeur à lait ou jus de fruit**



6 ltr.

matt poliert, Behälter gefrostet, Kühlung durch 2 Kühlakkus von oben und unten  
 satin polished finish, canister frosted look, cooling with 2 cooling elements from the top and base  
 inox acabado pulido mate, 1 recipiente policarbonato aspecto glaseado, 2 enfriadores en la base y en la tapa  
 inox mat, récipient polycarbonate opaque, 2 accus. de froid dans le socle et dans le couvercle

	cm	cm	ltr.	€
10865 3	21 x 35	48	6	264,00

**Einzelteile / spare parts / piezas sueltas / pièces détachées**

Milchbehälter, gefrostet, ohne Zapfhahn  
 milk canister, frosted look, without tap  
 contenedor de leche, efecto glaseado, sin grifo  
 récipient cylindrique mat (idéal pour le lait) sans le robinet

10805 9	Ø 22	26	6	111,00
---------	------	----	---	--------

Hahn / tap / grifo / robinet

10867 7				41,50
---------	--	--	--	-------

„gefrostet“  
 ideal für Milch

designed by **KIRCHHOFF & EUWENS**

**Saftdispenser DUO „SUNDAY“**  
**juice dispenser**  
**dispensador de zumo doble**  
**distributeur à jus de fruit double**



2 x 6 ltr.



matt poliert, Kühlung durch 4 Kühllakkus von oben und unten  
 satin polished finish, cooling with 4 cooling elements from the top and base  
 inox acabado pulido mate, 4 enfriadores en la base y en la tapa  
 inox mat, 4 accus. de froid (socle et couvercle)

	□ cm	↑ cm	ltr.	€
10862 2	35 x 45	48	2 x 6	399,00

**Einzelteile / spare parts / piezas sueltas / pièces détachées**

Saftbehälter transparent, ohne Zapfhahn / juice canister transparent, without tap  
 contenedor transparente sin grifo / récipient cylindrique sans le robinet

10806 6	Ø 22	26	6	106,00
---------	------	----	---	--------

Hahn / tap / grifo / robinet

10867 7				41,50
---------	--	--	--	-------

designed by **KIRCHHOFF & EUWENS**

**Saft- und Milchdispenser DUO „SUNDAY“**  
**juice and milk dispenser**  
**dispensador mixto zumo y leche**  
**distributeur mixte à lait et à jus de fruit**



2 x 6 ltr.



matt poliert, 1 Behälter gefrostet, 1 Behälter transparent, Kühlung durch 4 Kühllakkus von oben und unten

satin polished finish, 1 canister frosted look, 1 canister transparent, cooling with 4 cooling elements from the top and base

inox mate, 1 recipiente opaco, 1 recipiente transparente, 4 enfriadores (base y tapa)

inox mat, 1 récipient opaque, 1 récipient transparent, 4 accus. de froid (socle et couvercle)

	□ cm	↑ cm	ltr.	€
10864 6	35 x 45	48	2 x 6	399,00

**Einzelteile / spare parts / piezas sueltas / pièces détachées**

Saftbehälter transparent, ohne Zapfhahn / juice canister transparent, without tap  
 contenedor transparente sin grifo / récipient cylindrique sans le robinet

10806 6	Ø 22	26	6	106,00
---------	------	----	---	--------

Milchbehälter, gefrostet, ohne Zapfhahn

milk canister, frosted look, without tap

contenedor de leche, efecto glaseado, sin grifo

récipient cylindrique mat (idéal pour le lait) sans le robinet

10805 9	Ø 22	26	6	111,00
---------	------	----	---	--------

Hahn / tap / grifo / robinet

10867 7				41,50
---------	--	--	--	-------

**HOT PRICE**

8 ltr.

**Saftdispenser „INOX STAR“  
juice dispenser  
dispensador de zumo  
distributeur à jus de fruit**SAN  
KUNSTSTOFFEDELSTAHL  
STAINLESS  
INOXEdelstahl-Crasheisröhre herausnehmbar  
stainless steel crash ice tube  
con tubo inox refrigerante extraible para hielo picado  
avec tube inox réfrigérant amovible pour glace pilée

	□ cm	↑ cm	ltr.	€
10795 3	36 x 26	55	8	169,00

**Kühlung durch  
Crasheisröhre.  
Einfach mit  
Crasheis füllen!****HOT PRICE**2 x 8  
ltr.**Saftdispenser DUO „INOX STAR“  
juice dispenser  
dispensador de zumo  
distributeur à jus de fruit**SAN  
KUNSTSTOFFEDELSTAHL  
STAINLESS  
INOXEdelstahl-Crasheisröhre herausnehmbar  
stainless steel crash ice tube  
con tubo inox refrigerante extraible para hielo picado  
avec tubes inox réfrigérants amovibles pour glace pilée

	□ cm	↑ cm	ltr.	€
10810 3	36 x 52	55	2 x 8	339,00

**Einzelteile / spare parts / piezas sueltas / pièces détachées**

Behälter / container / recipiente / récipient

10796 0	8	35,70
---------	---	-------

Deckel 18/10 Edelstahl hochglanzpoliert / cover 18/10 stainless steel mirror polished finish  
tapa 18/10 inox pulido brillante / couvercle inox 18/10 poli brillant

10797 7	29,80
---------	-------

Crasheisröhre / crash ice tube / tubo para hielo picado / tube pour glace pilée

10798 4	23,80
---------	-------

Non-Drip Hahn / non-drip-tap / grifo anti-goteo / robinet anti-goutte

10799 1	22,00
---------	-------

Dichtungsring / sealing ring / arandela / rondelle

10793 9	1,50
---------	------

Silikondichtung / sealing / junta / joint

10794 6	2,00
---------	------

**Kühlung durch  
Crasheisröhre.  
Einfach mit  
Crasheis füllen!**



4 ltr.

**Der Kühlakku leitet die Kälte direkt in die Porzellan-Milchkanne.**

**Milchkanne „TOP FRESH“  
milk dispenser  
dispensador de leche  
distributeur à lait**



Kunststoff gefrostet, inkl. Porzellanschild zum Beschriften, 1 Kühlakku im Fuß  
acrylic frosted, incl. porcelain sign, 1 cooler in base  
acrílico glaseado, incluye cartelito en porcelana, 1 enfriador en la base  
socle acrylique, indicateur en porcelaine inclus, plaque de froid dans le socle

	□ cm	↑ cm	ltr.	€
10850 9	31 x 21	42	4	264,00

**Einzelteile / spare parts / piezas sueltas / pièces détachées**

Milchkanne Porzellan, ohne Zapfhahn / milkcan porcelain, without tap  
jarra de leche sin grifo / récipient en porcelaine sans robinet

10825 7	Ø 18	25	4	85,00
---------	------	----	---	-------



4 + 10 ltr.

**Der Kühlakku leitet die Kälte direkt in die Porzellan-Milchkanne.**

**Milchkanne „TOP FRESH“  
milk dispenser  
dispensador de leche  
distributeur à lait**



Buchen-Holz versiegelt, inkl. Porzellanschild zum Beschriften, 1 Kühlakku im Fuß  
beech wood, waterproof, incl. porcelain sign, 1 cooler in base  
madera de haya, resistente al agua, incluye placa de porcelana, 1 enfriador en la base  
socle bois hêtre traité, indicateur en porcelaine inclus, plaque de froid dans le socle

	□ cm	↑ cm	ltr.	€
10840 0	23 x 32	42	4	264,00
10757 1	27 x 38,5	45	10	310,00

**Einzelteile / spare parts / piezas sueltas / pièces détachées**

Milchkanne Porzellan, ohne Zapfhahn / milkcan porcelain, without tap  
jarra de leche sin grifo / récipient en porcelaine sans robinet

10825 7	Ø 18	25	4	85,00
10758 8	Ø 22	26	10	100,00

Deckel für 10840 / cover for 10840 / tapa para 10840 / couvercle pour 10840

10859 2				7,00
---------	--	--	--	------

Deckel für 10757 / cover for 10757 / tapa para 10757 / couvercle pour 10757

10759 5				14,30
---------	--	--	--	-------

Schild und Kette / shield and chain / placa y cadena / indicateur porcelaine avec chaînette

10756 4				5,00
---------	--	--	--	------

Zapfhahn / tap / grifo / robinet

10907 0				29,00
---------	--	--	--	-------

**2 Größen  
2 sizes**



3 ltr.  
10835

5 ltr.  
10755

**Milchkanne WOOD „TOP FRESH“**  
milk dispenser  
dispensador de leche  
distributeur à lait



Buchen-Holz versiegelt, 1 Kühlakku im Standfuß, „original Milchkanne mit Henkel“  
beech wood, 1 cooler in base, original milkcan  
madera de haya, 1 acumulador de frio en base  
bois de hêtre, 1 plaque de froid dans le socle

	cm	↑ cm	ltr.	€
10835 6	21 x 32	39	3	305,00
10755 7	23 x 35	47	5	499,00



6 + 5 ltr.

**Saft- und Milchdispenser MIX „TOP FRESH“**  
juice and milk dispenser  
dispensador mixto zumo y leche  
distributeur mixte à lait et à jus de fruit



6 Liter Saftbehälter, 5 Liter Milchkanne, Kühlung durch 2 Kühlakkus von oben und unten  
6 liters juice container, 5 liters milkcan, cooling with 2 cooling elements from the top and base  
recipiente de zumo 6 litros, recipiente de leche 5 litros, 2 enfriadores  
récipient à jus 6 l, récipient à lait 5 l, 2 accus. de froid

	cm	↑ cm	ltr.	€
10760 1	42 x 35	52	6 + 5	710,00



3 ltr.  
10830

5 ltr.  
10750

**Milchkanne „TOP FRESH“**  
milk dispenser  
dispensador de leche  
distributeur à lait



hochglanzpoliert, 1 Kühlakku im Standfuß, „original Milchkanne mit Henkel“  
mirror polished finish, 1 cooler in base, original milkcan  
inox brillante, 1 acumulador de frio en la base, recipiente „lechera“  
inox poli brillant, 1 accum. de froid dans le socle, design „pot à lait“

	cm	↑ cm	ltr.	€
10830 1	21 x 32	39	3	279,00
10750 2	23 x 35	45	5	444,00

**Einzelteile / spare parts / piezas sueltas / pièces détachées**

Milchkanne ohne Zapfhahn / milkcan without tap  
jarra de leche sin grifo / récipient à lait sans robinet

10833 2	Ø 16	22	3	162,00
10663 5	Ø 22	26	5	199,00

# BRIDGE designed by CULTURE FORM



2 Größen / 2 sizes  
4 + 6 ltr.

siehe auch Seite 198 / page 198

Buffet . Banquet  
buffet . banquet



## Saftdispenser „BRIDGE“ juice dispenser dispensador de zumo distributeur à jus de fruit



Kühlung durch 2 Kühllakkus von oben und unten  
cooling with 2 cooling elements from the top and base  
2 acum. de frío 1 en la base y 1 en la tapa  
2 plaques de froid 1 dans le couvercle, 1 dans le socle

	□ cm	↑ cm	ltr.			€
10870 7	31,0 x 20,0	42	4	Ahorn	●	224,00
10871 4	35,5 x 22,0	50	6	Ahorn	●	264,00
10872 1	31,0 x 20,0	42	4	Wenge	●	224,00
10873 8	35,5 x 22,0	50	6	Wenge	●	264,00

inklusive 3 Magnetschilder:  
„ORANGE“  
„APPLE“  
„GRAPEFRUIT“



### Einzelteile / spare parts / piezas sueltas / pièces détachées

Deckel / cover / tapa / couvercle

		für ltr. / for ltr. / para ltr. / pour l.	€
1)	10701	4 6	25,00
1)	10801	1 4	21,00

Kühlakku / cooler / acumulador de frío / accumulateur de froid

2)	10777	9 4 / 6	5,00
----	-------	---------	------

Behälter inkl. Zapfhahn / container inc. tap / recipiente con grifo / récipient avec robinet

3)	10703	8 6	157,00
3)	10803	5 4	134,00

Softbehälter transparent, ohne Zapfhahn / juice canister transparent, without tap  
 contenedor transparente sin grifo / récipient cylindrique sans le robinet

3)	10704	5 6	118,00
3)	10804	2 4	97,00

Non-Drip Hahn / non-drip tap / grifo anti-goteo / robinet anti-goutte

4)	10707	6 6	45,00
4)	10807	3 4	43,00

Dichtungsring / sealing ring / arandela / rondelle

5)	10608	8 4 / 6	1,60
----	-------	---------	------

Einsatz / insert / aro inox / cercle inox

6)	10708	3 6	4,40
6)	10808	0 4	4,40

Standfuß 18/10 Edelstahl / column 18/10 stainless steel  
 base inox 18/10 / socle inox 18/10

7)	10709	0 6	70,00
7)	10809	7 4	52,50

Tropfgitter 18/10 Edelstahl / drip lattice 18/10 stainless steel  
 rejilla recoge gotas 18/10 / grille ramasse-gouttes 18/10

8)	10712	0 6	24,00
8)	10713	7 DUO	39,00
8)	10812	7 4	21,00

Bodenplatte 18/10 Edelstahl / footing 18/10 stainless steel  
 base de 18/10 acero / socle inox 18/10

9)	10710	6 6	47,00
9)	10711	3 DUO / 6 + 6	94,00
9)	10814	1 4	33,00

### Zubehör / Reinigungsset - für die regelmäßige Reinigung

1x Dichtung, 2x Dichtungsring (transparent), 1x Dichtungsring (schwarz / weiß)

1x seal, 2x sealing ring (transparent), 1x sealing ring (black / white)

			€
10714	4	für Zapfhahn 10707	3,20
10715	1	für Zapfhahn 10807	3,20
10716	8	für Zapfhahn 10907	4,20
10717	5	für Zapfhahn 10867	4,10



Chafing Dish . Chafing Dish Zubehör  
chafing dish . chafing dish extras  
chafing dish y accesorios  
chafing dish et accessoires

Chafing Dish  
chafing dish

# PREMIUM



## Chafing Dish GN1/1 „PREMIUM“



1 Gestell + 1 Wasserbecken mit Sandwichboden + 1 Wasserbeckenrahmen + 1 Deckel mit hydraulischem Gelenk + 1 GN1/1 Behälter 65 mm tief, hitzebeständige Griffe, hochwertige Verarbeitung, ausschließlich für Induktionskochfelder

1 frame + 1 waterpan with sandwich base + 1 frame for waterpan + 1 hydraulic cover + 1 GN1/1 container 65 mm, heat-resistant handles, high quality, only for induction plates

1 marco, 1 baño maría con base sandwich, 1 marco con tapa hidráulica, 1 cubeta GN1/1 pan 65 mm profundo, asas resistentes al calor, buenos acabados, solamente para inducción

1 pied support, 1 bac bain-marie avec fond sandwich, 1 cadre avec couvercle hydraulique, 1 bac GN1/1 - 65mm, poignées résistantes à la chaleur, belle qualité, uniquement pour induction

	cm	cm	ltr.		€
12370 0	66 x 48	33	9	mit Edelstahldeckel with stainless cover	894,00
<b>NEW</b> 12352 6	66 x 48	33	9	mit Glasdeckel with glass cover	1140,00

## Einzelteile / spare parts / piezas sueltas / pièces détachées

Induktionskochplatte für Chafing Dish / induction plate for chafing dish  
placa de inducción para chafing dish / plaque à induction pour chafing dish

12295 6	900 W	129,00
---------	-------	--------



### Langlebige Deckelbremse

Abnehmbarer Deckel, dieser lässt sich spielend leicht öffnen und schliessen, der Lauf des Deckels wird professionell gedämpft.



### Kondenswasser - Rücklaufsystem

Kondenswasser wird in das Wasserbecken zurückgeführt.



### Sandwichboden / Kapselboden

Induktionsfähiger Boden, direkt auf dem Induktionskochfeld einsetzbar. Perfekte Wärmeverteilung und Steuerung.



12371  
6 ltr.

12353  
6 ltr.  
mit Glasdeckel

### Chafing Dish rund „PREMIUM“



1 Gestell + 1 Wasserbecken mit Sandwichboden + 1 Wasserbeckenrahmen + 1 Deckel mit hydraulischem Gelenk + 1 runder Speisenbehälter, hitzebeständiger Griff, hochwertige Verarbeitung, für Induktionskochfelder geeignet

1 frame + 1 waterpan with sandwich base + 1 frame for waterpan + 1 hydraulic cover + 1 round foodpan, heat-resistant handles, high quality, good for induction plates

1 soporte, 1 baño maría con base sandwich, 1 marco con baño maría, 1 tapa hidráulica, 1 cubeta redonda, asas resistente al calor, buen acabado, apto para inducción

1 pied support, 1 bac bain-marie avec fond sandwich, 1 cadre avec couvercle hydraulique, 1 bac rond, poignées résistante à la chaleur, belle qualité, uniquement pour induction

	□ cm	↑ cm	ltr.		€
12371 7	44 x 54	33	6	mit Edelstahldeckel with stainless cover	780,00
<b>NEW</b> 12353 3	44 x 54	33	6	mit Glasdeckel with glass cover	890,00

#### Einzelteile / spare parts / piezas sueltas / pièces détachées

Induktionskochplatte für Chafing Dish / induction plate for chafing dish  
placa de inducción para chafing dish / plaque à induction pour chafing dish

12295 6	900 W	129,00
---------	-------	--------

Speiseneinsatz / foodpan / cubeta / bac supérieur

12366 3	6 ltr.	24,00
---------	--------	-------



12372  
10 ltr.

12354  
10 ltr.  
mit Glasdeckel

### Chafing Dish rund „PREMIUM“



1 Gestell + 1 Wasserbecken mit Sandwichboden + 1 Wasserbeckenrahmen + 1 Deckel mit hydraulischem Gelenk + 1 runder Speisenbehälter, hitzebeständige Griffe, hochwertige Verarbeitung, für Induktionskochfelder geeignet

1 frame + 1 waterpan with sandwich base + 1 frame for waterpan + 1 hydraulic cover + 1 round foodpan, heat-resistant handles, high quality, good for induction plates

1 soporte, 1 baño maría con base sandwich, 1 marco con baño maría, 1 tapa hidráulica, 1 cubeta redonda, asas resistente al calor, buen acabado, apto para inducción

1 pied support, 1 bac bain-marie avec fond sandwich, 1 cadre avec couvercle hydraulique, 1 bac rond, poignées résistante à la chaleur, belle qualité, uniquement pour induction

	□ cm	↑ cm	ltr.		€
12372 4	44 x 48	39	10	mit Edelstahldeckel with stainless cover	780,00
<b>NEW</b> 12354 0	44 x 48	39	10	mit Glasdeckel with glass cover	890,00

#### Einzelteile / spare parts / piezas sueltas / pièces détachées

Induktionskochplatte für Chafing Dish / induction plate for chafing dish  
placa de inducción para chafing dish / plaque à induction pour chafing dish

12295 6	900 W	129,00
---------	-------	--------

Speiseneinsatz / foodpan / cubeta / bac supérieur

12397 7	10 ltr.	18,00
---------	---------	-------



**Fixierschraube / Rutschsicherung**  
Höhenverstellbares Gelenk, fixiert das Gerät in dem Gestell und auf dem Tisch.



**Induktionskochplatte** Nr.12295  
Induktionskochplatte wird einfach in das Gestell gelegt.



**Stapelbar**  
Chafing Dish Rahmen sind übereinander stapelbar. Platzsparend und rutschfest stapeln und transportieren.

# GLOBE



die Deckelbremse sorgt für langsames Schließen

the revolving cover closes gently, thanks to a special built-in axle resistance

los frenos del sistema garantizan un cierre suave de la tapa

système avec frein pour une fermeture en douceur du couvercle



abnehmbarer Deckel mit Wasserrücklaufsystem

lid can be taken off, with water runback system

tapa fácil de desmontar, y canal incorporado para recuperar el agua condensada

couvercle facile à démonter, rainure pour récupérer les gouttes de condensation



Kondenswasser wird in das Wasserbecken zurückgeführt

condensed water is led back into the waterpan

el agua de condensación vuelve a la cubeta de agua

l'eau de condensation retourne dans le bac d'eau



für alle Herdarten geeignet, auch für Induktionskochplatten

suitable for all kinds of ovens, even induction cookers

apto para todas las fuentes de calor, incluso inducción

apte pour toutes les sources de chaleur, y compris induction



12394



12404  
GN1/1 / 9 ltr.



12295



12296

**Induktionsplatte kann nur in Verbindung mit dem entsprechenden Rahmen genutzt werden**

## Chafing Dish „GLOBE“



hochglanzpoliert, mit abnehmbarem hydraulischen Edelstahl-Deckel, Sandwichboden sorgt für optimale Wärmeleitung, für Induktionsplatten geeignet

Set: Gestell + Wasserbecken + Speisenbehälter GN1/1 65 mm tief + Löffelablage + 2 Brennpastenbehälter + Metallrahmen für Induktionskochplatte

mirror polished finish, removable hydraulic cover, sandwich base, optimum heat distribution set: frame + waterpan + foodpan GN1/1, 65 mm, 9 l + cutlery compartment ladles + 2 burner holder + frame for induction plate

pulido brillante, con tapa hidráulica extraíble, fondo difusor sandwich apto para inducción. Incluye: 1 pie, 1 cubeta baño maría, 1 cubeta GN 1/1 65 mm, 1 soporte para cuchara (sin cuchara), 2 quemadores, marco inox para la placa de inducción

poli brillant, couvercle hydraulique amovible, fond diffuseur sandwich apte pour induction. Comprend: pied, cuve bain-marie, bac inox GN 1/1-65 mm - 5,5 L, porte-louche (louche non incluse), 2 brûleurs, cadre inox pour la plaque à induction

	cm	cm	GN	ltr.	€
12394 6	66,5 x 44,0	34	1/1	9	556,00
12404 2	66,5 x 44,0	34	Set mit Edelstahl- / Glasdeckel set with cover stainless steel / glass con tapa inox con ventana avec couvercle inox et fenêtre verre		556,00

## Einzelteile / spare parts / piezas sueltas / pièces détachées

Deckel mit Glasfenster / cover with glass insert / tapa con cristal / couvercle inox et verre

12391 5 234,00

Deckel Edelstahl / cover stainless steel / tapa de acero inoxidable / couvercle tout inox

12386 1 234,00

Metallrahmen für Induktionskochplatte / frame for induction plate  
estructura o marco para placa de inducción / cadre support inox pour plaque induction

12296 3 18,00

Induktionskochplatte für Chafing Dish / induction plate for chafing dish  
placa de inducción para chafing dish / plaque à induction pour chafing dish

12295 6 900 W 129,00



10 ltr.

**Suppen-Kugel „GLOBE“**  
soup bowl  
cubeta sopa  
récipient à soupe



hochglanzpoliert, inkl. Speisenbehälter, mit einhängbarer Löffelablage, Sandwichboden sorgt für optimale Wärmeverteilung, für Induktionsplatten geeignet, einfaches Anbringen und Entfernen des Deckels, hitzeisolierende Griffe (Lieferung ohne Löffel)

mirror polished finish, incl. foodpan, with fitting compartment for ladles, sandwich bottom for optimum heat distribution, gentle opening of the lid, heat-resistant handles (delivery without ladle)

acabado pulido brillante, cubeta sopa inox, platillo a colgar para el cucharón, fondo difusor sandwich, apto para inducción, tapa con apertura controlada, asas frías (cucharón no incluido)

poli brillant, récipient à soupe inox, repose-couvert à accrocher, fond diffuseur sandwich, apte pour induction, couvercle à ouverture contrôlée, anses froides (louche non incluse)

	cm	cm	ltr.	€
12399 1	Ø 48	32	10	374,00

**Einzelteile / spare parts / piezas sueltas / pièces détachées**

Gestell inkl. Brenner / frame incl. burner / soporte incluyendo quemador / support, brûleur inclus

12396 0				62,00
---------	--	--	--	-------

Speisenbehälter / foodpan / cubeta superior / bac supérieur

12397 7			10 ltr.	18,00
---------	--	--	---------	-------



10 ltr.

**Suppen-Kugel inkl. Gestell „GLOBE“**  
soup bowl with stand  
cubeta sopa con soporte  
récipient à soupe avec pied



hochglanzpoliert, inkl. Speisenbehälter, 1 Brennpastenbehälter, mit einhängbarer Löffelablage, Sandwichboden sorgt für optimale Wärmeverteilung, für Induktionsplatten geeignet, einfaches Anbringen und Entfernen des Deckels, hitzeisolierende Griffe, 1 Metallrahmen für Induktionskochplatten

mirror polished finish, incl. foodpan and 1 burner holder, with fitting compartment for ladles, sandwich bottom for optimum heat distribution, gentle opening of the lid, heat-resistant handles, frame for induction plate

acabado pulido brillante, cubeta sopa inox, 1 quemador, platillo a colgar para el cucharón, fondo difusor sandwich, apto para inducción, tapa con apertura controlada, asas frías, marco para placa de inducción

poli brillant, récipient à soupe inox, 1 brûleur, repose-couvert à accrocher, fond diffuseur sandwich, apte pour induction, couvercle à ouverture contrôlée, anses froides, cadre support inox pour plaque à induction

	cm	cm	ltr.	€
12398 4	Ø 48	45	10	429,00

**Einzelteile / spare parts / piezas sueltas / pièces détachées**

Metallrahmen für Induktionskochplatten / frame for induction plate  
marco para placa de inducción / cadre support inox pour plaque induction

12291 8				17,00
---------	--	--	--	-------

Induktionskochplatte für Chafing Dish / induction plate for chafing dish  
placa de inducción para chafing dish / plaque à induction pour chafing dish

12295 6	900 W			129,00
---------	-------	--	--	--------



6 ltr.



12390



12295



12291

## Chafing Dish „GLOBE“



hochglanzpoliert, mit abnehmbarem hydraulischen Edelstahl-Deckel, Sandwichboden sorgt für optimale Wärmeleitung, für Induktionsplatten geeignet

Set: Gestell + Wasserbecken + Speisenbehälter rund + Löffelablage + Brennpastenbehälter + Metallrahmen für Induktionskochplatte

mirror polished finish, removable hydraulic cover, sandwich base, optimum heat distribution set: frame + waterpan + foodpan round + cutlery compartment ladles + burner holder + frame for induction plate

pulido brillante, con tapa hidráulica extraíble, fondo difusor sandwich apto para inducción. Incluye: 1 pie, 1 cubeta baño maría, 1 cubeta redonda, 1 soporte para cuchara (sin cuchara), 1 quemador, marco inox para la placa de inducción

brillant, couvercle hydraulique amovible, fond diffuseur sandwich apte pour induction.

Comprend: pied, cuve bain-marie, bac inox rond, porte-louche (louche non incluse), 1 brûleur, cadre inox pour la plaque à induction

	cm	cm	ltr.		€
12393 9	Ø 38,5	34	6		478,00
12403 5	Ø 38,5	34	6	mit Edelstahl- / Glasdeckel with cover stainless steel / glass con tapa de acero inoxidable y cristal avec couvercle inox et fenêtre verre	484,00

## Einzelteile / spare parts / piezas sueltas / pièces détachées

Deckel mit Glasfenster / cover with glass insert / tapa con cristal / couvercle inox et verre

12390 8	220,00
---------	--------

Deckel Edelstahl / cover stainless steel / tapa de acero inoxidable / couvercle tout inox

12385 4	220,00
---------	--------

Metallrahmen für Induktionskochplatten / frame for induction plate  
marco para placa de inducción / cadre support inox pour plaque induction

12291 8	17,00
---------	-------

Induktionskochplatte für Chafing Dish / induction plate for chafing dish  
placa de inducción para chafing dish / plaque à induction pour chafing dish

12295 6	900 W	129,00
---------	-------	--------

Speiseneinsatz / foodpan / cubeta / bac supérieur

12366 3	6 ltr.	24,00
---------	--------	-------

**Induktionsplatte kann  
nur in Verbindung mit dem  
entsprechenden Rahmen  
genutzt werden**



82210

## Porzellan-Einsatz porcelain insert bandeja de porcelana bac supérieur en porcelaine



	cm	cm	ltr.		€
82210 8	Ø 39	6,5	4,3	rund / round / redondo / rond	98,00
82215 3	Ø 39	6,5	4,0	unterteilt / subdivided 2 compartimentos / 2 compartiments	100,00



82215

**NEW**



**GN2/3 / 5,5 Liter**

**Chafing Dish „GLOBE“**

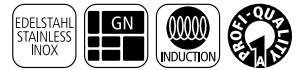

hochglanzpoliert, mit abnehmbarem hydraulischen Edelstahl-Deckel, Sandwichboden sorgt für optimale Wärmeleitung, für Induktionsplatten geeignet, Set: Gestell + Wasserbecken + 1 GN2/3 Behälter 65 mm tief + Löffelablage + 1 Brennpastenbehälter + 1 Metallrahmen für Induktionskochplatte

mirror polished finish, removable hydraulic cover, sandwich base, optimum heat distribution, set: frame + waterpan + foodpan GN 2/3, 65 mm, 5,5 l + compartment for ladles + burner holder + frame for induction plate

pulido brillante, con tapa hidráulica extraíble, fondo difusor sandwich apto para inducción. Incluye: 1 pie, 1 cubeta baño maría, 1 cubeta GN 2/3 65 mm - 5,5 l, 1 soporte para cuchara (sin cuchara), 1 quemador, marco inox para la placa de inducción

poli brillant, couvercle hydraulique amovible, fond diffuseur sandwich apte pour induction. Comprend: pied, cuve bain-marie, bac inox GN 2/3-65 mm - 5,5 L, porte-louche (louche non incluse), brûleur, cadre inox pour la plaque à induction

	□ cm	↑ cm	GN	ltr.		€
12483 7	44 x 41	34	2/3	5,5	mit Edelstahl-Deckel / with stainless steel cover /	498,00
12484 4	44 x 41	34	2/3	5,5	mit Glas-Deckel / with glass cover	498,00



**Rolltop-Chafing Dish „ELITE“**



poliert, Rolltop-Deckel klappbar auf 90° und 180°, Speisenbehälter GN1/1 65 mm tief + Wasserbecken + 2 Brennpastenbehälter, wechseln des GN-Behälters ohne abnehmen des Deckels (kein Kondenswasser-Rücklaufsystem)

polished, rolltop cover adjustable at 90° and 180°, foodpan GN1/1 65 mm deep + waterpan + 2 burner holders, change of the GN container without removing the lid (condensed water can not be led back into the waterpan)

pulido brillante, tapa rolltop a 90° o 180°, cubeta GN 1/1 + 2 quemadores, cuba baño maría, se puede cambiar la cubeta GN sin retirar la tapa, importante: el agua condensada no revierte en los alimentos

poli brillant, couvercle rolltop ouverture de 90 a 180°, bac GN 1/1, bain-marie, 2 brûleurs, le bac GN peut être retiré et remplacé sans démonter le couvercle, important: la condensation ne retombe pas sur les aliments

	□ cm	↑ cm	ltr.	€
12350 2	67 x 47	45	9	229,00

**Einzelteile / spare parts / piezas sueltas / pièces détachées**

Wasserbecken inkl. Vorrichtung für Heizelement / waterpan / baño maría / bain-marie

12249 9	38,40
---------	-------



12249  
Wasserbecken inkl.  
Vorrichtung für Heizplatte



stapelbar

**NEW**

**Chafing Dish „WINDOW“**



12320

poliert, Rolltop-Deckel klappbar auf 90° und 180°, Speisenbehälter 65 mm tief + Wasserbecken + 2 Brennpastenbehälter, wechseln des Behälters ohne abnehmen des Deckels (kein Kondenswasser-Rücklaufsystem)

polished, rolltop cover adjustable at 90° and 180°, foodpan 65 mm deep + waterpan + 2 burner holders, change of the container without removing the lid (condensed water can not be led back into the waterpan)

pulido brillante, tapa rolltop a 90° o 180°, cubeta de 65 mm+ 2 quemadores, cuba baño maría. Se puede cambiar la cubeta sin retirar la tapa. Importante: el agua condensada no revierte en los alimentos

poli brillant, couvercle rolltop ouverture de 90° a 180°, bac de 65 mm , bain-marie, 2 brûleurs. Le bac peut être retiré et remplacé sans démonter le couvercle. Important: la condensation ne retombe pas sur les aliments.



12321

	cm	↑ cm	ltr.	GN	€
12320 5	64 x 46	44	9	1/1	240,00
12321 2	Ø 48	46	6	rund	190,00

**Einzelteile / spare parts / piezas sueltas / peças soltas**

Elektro-Heizelement / heating unit / resistencia / résistance

		€
12290 1	360 W - 140-250 V	116,00
12292 5	600 W - 230 V	120,00
12294 9	800 W - 230 V	154,00

Wasserbecken / waterpan / cubeta para el agua / bac bain-marie

12249 9	38,40
---------	-------



**wechseln des GN-Behälters ohne abnehmen des Deckels (kein Kondenswasser-Rücklaufsystem)**



vorbefestigte Halterung für das Heizelement



befestigte Heizelemente 12290 / 12292 / 12294





inkl. Vorrichtung für Heizelement

### Chafing Dish „CATERER“



Speisenbehälter GN1/1 65 mm tief + 2 Brennpastenbehälter + Wasserbecken inkl. Vorrichtung für Heizelement + Deckel + Gestell mit Deckelhalterung (Lieferung ohne Heizelement)

foodpan GN1/1 65 mm deep + 2 burner holders + 1 waterpan with screws for heating unit + cover + frame with coverholder (without heating unit)

1 cubeta GN 1/1 - 65 mm + 2 quemadores + cuba baño maría con fijaciones para resistencia amovible + estructura con bloqueo tapa (se sirve sin la resistencia)

1 bac GN 1/1 - 65 mm + 2 brûleurs + 1 bac bain-marie avec 4 vis pour fixation d'une résistance de chauffe amovible (non incluse) + couvercle + chassis avec blocage couvercle

	□ cm	↑ cm	ltr.	€
12240 6	67 x 35	35	9	147,00

#### Einzelteile / spare parts / piezas sueltas / pièces détachées

Ersatzdeckel / replacement cover / tapa de recambio / couvercle de rechange

12260 4	34,00
---------	-------

Wasserbecken inkl. Vorrichtung für Heizelement / waterpan / baño maría / bain-marie

12249 9	38,40
---------	-------



inkl. Vorrichtung für Heizelement

für bis zu 100 mm tiefe GN-Behälter geeignet

### Chafing Dish „CATERER PRO“



Deckel hochglanzpoliert, Deckelgriffe hitzebeständig + 2 Brennpastenbehälter + Wasserbecken, inkl. Vorrichtung für Heizplatte + Gestell mit Deckelhalterung (ohne GN Speisenbehälter)

cover mirror polished finish, cover knob heat-resistant + 2 burner holders + waterpan with screws for heating unit + frame with coverholder (without GN foodpan)

tapa pulido brillante, asas frías + 2 quemadores + cuba inferior con tornillos para resistencia removible (no incluida) + tapa y estructura con sujeción de la tapa (se sirve sin la cubeta GN)

couvercle poli brillant, anses froides + 2 brûleurs + bac bain-marie avec fixations pour résistance amovible (non incluse)

	□ cm	↑ cm	€
12233 8	64 x 35	34	139,00

#### Einzelteile / spare parts / piezas sueltas / pièces détachées

Ersatzdeckel / replacement cover / tapa de recambio / couvercle de rechange

12236 9	36,00
---------	-------

Wasserbecken inkl. Vorrichtung für Heizelement / waterpan / baño maría / bain-marie

12249 9	38,40
---------	-------

durch umgedrehten Deckel im Wasserbecken sind Chafer rutschfest stapelbar



inkl. Vorrichtung für Heizelement

### Rolltop-Chafing Dish „CATERER“



Speisenbehälter GN1/1 65 mm tief + Rolltop-Deckel 90° + Wasserbecken inkl. Vorrichtung für Heizplatte + 2 Brennpastenbehälter (Lieferung ohne Heizplatte), massiver Ständer

foodpan GN1/1 65 mm deep + rolltop cover 90° + waterpan with screws for heating unit + 2 burner holders (without heating unit), stable frame

1 cubeta GN 1/1 - 65 mm + campana rolltop abatible a 90° + 2 quemadores + cuba baño maría con fijaciones para resistencia amovible (se sirve sin la resistencia)

1 bac GN 1/1 - 65 mm + couvercle rolltop ouverture 90° + 2 brûleurs + 1 bac bain-marie avec 4 vis pour fixation résistance de chauffe amovible (non incluse)

	□ cm	↑ cm	ltr.	€
12245 1	67 x 35	45	9	219,00

#### Einzelteile / spare parts / piezas sueltas / pièces détachées

Wasserbecken inkl. Vorrichtung für Heizelement / waterpan / baño maría / bain-marie

12249 9	38,40
---------	-------



inkl. Vorrichtung für Heizelement

### Rolltop-Chafing Dish „MAESTRO“



Speisenbehälter GN1/1 65 mm tief (passend auch für 100 mm) + Rolltop-Deckel 90° + Wasserbecken inkl. Vorrichtung für Heizplatte + 2 Brennpastenbehälter

foodpan GN1/1 65 mm (also for 100 mm) + rolltop cover 90° + waterpan with screws for heating unit + 2 burner holders

cubeta GN 1/1 - 65 mm (hay espacio para una cubeta 100 mm) + campana rolltop abatible a 90° + 2 quemadores + cuba baño maría con fijaciones para resistencia amovible (se sirve sin la resistencia)

bac GN 1/1 - 65 mm (accepte aussi bac ht. 100 mm) + couvercle rolltop ouverture 90° + 2 brûleurs + bac bain-marie avec 4 vis pour fixation résistance de chauffe amovible (non incluse)

	cm	cm	litr.	€
12300 7	67 x 35	45	9	189,00



### Besteck-Ablage cutlery rest reposa cuchara pose-cuillère

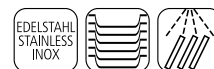

hochglanzpoliert, ideal für das hygienische Ablegen von Kochlöffeln, Lieferung ohne Löffel

mirror polished finish, ideal for lay down spoon, delivery without spoon

acabado espejo pulido (sin cuchara)

effet brillant (livré sans la cuillère)

	cm	cm		€
00650 8	27 x 11	3,5		8,00

designed by CULTURE FORM



### Besteck-Ablage „BOWL“ cutlery rest reposa cuchara pose-cuillère



	cm	cm	litr.	€
83803 1	22,5 x 11	6	0,5	6,40

designed by CULTURE FORM



### Besteck-Ablage „SPOON“ cutlery rest reposa cuchara pose-cuillère



	cm	cm		€
83801 7	16 x 10,5	5		6,00



mit rutschfestem Boden  
with non-slip bottom  
con pies antideslizantes  
avec pieds antidérapants

### Besteck-Ablage „SMALL WAVE“ cutlery rest reposa cuchara pose-cuillère



	cm	cm		€
83897 0	26 x 13	4,5		8,90

**HOT  
PRICE**



**inkl. GN1/1  
Behälter**

### Chafing Dish „CHEF“



Speisenbehälter GN1/1 65 mm tief + 2 Brennpastenbehälter + Wasserbecken + Deckel + Gestell mit Deckelhalterung + langer Hohlgriff

foodpan GN1/1 65 mm + 2 burner holders + waterpan + cove + frame with coverholder

1 cubeta GN 1/1 65 mm + 2 quemadores + cubeta para el agua + tapa y chasis con bloqueo para la tapa

1 bac GN 1/1 - 65 mm + 2 brûleurs + 1 bac bain-marie + couvercle + chassis avec blocage couvercle + poignée tube creux

	cm	cm	ltr.	€
11675 7	61 x 31	30	9	66,00

**HOT  
PRICE**



**inkl. 2 x GN1/2  
+ 1 x GN1/1 Behälter**

### Chafing Dish Set „CHEF PLUS“



Speisenbehälter GN1/1 65 mm tief + 2 Behälter GN1/2 65 mm tief + 2 Brennpastenbehälter + Wasserbecken + Deckel + Gestell mit Deckelhalterung

foodpan GN1/1 65 mm deep + 2 foodpans GN1/2 65 mm deep + 2 burner holders + waterpan + cover + frame with coverholder

1 cubeta GN 1/1 - 65 mm + 2 cubetas GN 1/2 - 65 mm + 2 quemadores + 1 cuba baño maría + tapa y marco para sujetar la tapa

1 bac GN 1/1 - 65 mm + 2 bacs GN 1/2 - 65 mm + 2 brûleurs + 1 bac bain-marie + couvercle, chassis avec blocage couvercle

	cm	cm	ltr.	€
11686 3	61 x 31	30	9	76,00

**HOT  
PRICE**



11695  
**ECONOMIC**  
3,5 ltr.



11692  
**CHEF**  
7,5 ltr.

### Chafing Dish



Speisenbehälter + Wasserbecken + 1 Brennpastenbehälter + Deckel + Gestell

foodpan + waterpan + 1 burner holder + cover + frame

cubeta redonda + baño maría + 1 quemador + tapa + soporte

réipient + bain-marie + 1 brûleur + couvercle + support

	cm	cm	ltr.	€
11695 5	Ø 34	26	3,5	48,00
11692 4	Ø 34	34	7,5	64,00
11657			3,5	Ersatzspeisebehälter für 11695 16,00
11658			7,5	Ersatzspeisebehälter für 11692 18,00



11696  
11 ltr.



11678  
13,5 ltr.

### Hot Pot / Suppentopf



Speisenbehälter + Wasserbecken + 1 Brennpastenbehälter + Deckel + Gestell

foodpan + waterpan + 1 burner holder + cover + frame

cubeta + baño maría + 1 quemador + tapa + soporte

réipient + bain-marie + 1 brûleur + couvercle + support

	cm	cm	ltr.	€
11696 2	Ø 30	36	11,0	69,00
11678 8	Ø 33	35	13,5	79,00

**HOT  
PRICE**



### Chafing Dish „ECONOMIC“



Speisenbehälter GN1/1 65mm tief + 2 Brennpastenbehälter + Wasserbecken + Deckel, Gestell mit Deckelhalterung

foodpan GN1/1 65 mm + 2 burner holders + waterpan + cover, frame with coverholder

cubeta GN 1/1 65 mm + 2 quemadores+ cubeta para el agua + bloqueo para la tapa

1 bac GN 1/1 - 65 mm + 2 brûleurs + 1 bac bain-marie + couvercle + chassis avec blocage couvercle

	cm	cm	ltr.	€
11680 1	61 x 36	30	9	63,00
11680 1	61 x 36	30	9 ≥ 21 pcs.	58,00
11618 4	61 x 36	30	ohne Speisenbehälter without foodpan sin la cubeta sans le bac GN	49,60

**HOT  
PRICE**



**inkl. 2 x GN1/2  
Behälter**

### Chafing Dish „BUFFET“



2 Speisenbehälter GN1/2 65 mm tief + 2 Brennpastenbehälter + Wasserbecken + Deckel, Gestell mit Deckelhalterung

2 foodpans GN1/2 65 mm deep + 2 burner holders + waterpan + cover, frame with coverholder

2 cubetas GN 1/2 - 65 mm + 2 quemadores+ cubeta para el agua + tapa y bloqueo para la tapa

2 bacs GN 1/2 - 65 mm + 2 brûleurs + 1 bac bain-marie + couvercle + chassis avec blocage couvercle

	cm	cm	ltr.	€
11685 6	61 x 36	30	2 x 3,5	69,00

**HOT  
PRICE**



**2er Set**

### Chafing Dish „TWIN“, 2er Set



komplette Sets, inkl. GN1/1 Speisenbehälter 65 mm tief

complete sets, incl. GN1/1 foodpan 65 mm deep

2 chafing dish completos con cubetas GN 1/1

2 chafing dish complets avec bacs GN 1/1

	cm	cm	ltr.	pcs.	€
11699 3	61 x 36	30	9	2	99,00



**Kaffeedispenser „ROYAL“**  
**coffee dispenser**  
**dispensador de café**  
**distributeur de café**



12 ltr.

hochglanzpoliert, für warme Getränke, stabil und standfest, inkl. 1 Brennpastenbehälter  
 mirror polished finish, for warm drinks, solid and stable, incl. 1 burner holder  
 acabado brillante para bebidas calientes, sólido y estable, incluye un calentador  
 brillant, pour boissons chaudes, avec 1 brûleur, robuste et stable

	☐ cm	↑ cm	ltr.	€
11667 2	28 x 28	65	12	256,00



**Kaffeedispenser „HAPPY HOUR“**  
**coffee dispenser**  
**dispensador de café**  
**distributeur de café**



10,5 ltr.

hochglanzpoliert, für warme Getränke, stabil und standfest, inkl. 1 Brennpastenbehälter  
 mirror polished finish, for warm drinks, solid and stable, incl. 1 burner holder  
 acabado pulido brillante para bebidas calientes, sólido y estable, incluye un calentador  
 brillant, pour boissons chaudes, avec 1 brûleur, robuste et stable

	☐ cm	↑ cm	ltr.	€
11672 6	31 x 33,5	54,5	10,5	190,00

**Einzelteile / spare parts / piezas sueltas / pièces détachées**

Hahn / tap / grifo / robinet

11671 9				25,00
---------	--	--	--	-------

Heizelement, 500 W, 220 V, einfach in das Gestell des Dispensers legen

heating unit, 500 W, 220 V, insert into the frame of the dispenser

resistencia, 500 W, 220V, directamente en el pie del dispensador

résistance, 500 W, 220 V, directement dans le support

12287 1	21 x 20	6		98,00
---------	---------	---	--	-------



**passendes Heizelement**  
**wird in das Gestell eingelegt,**  
**regelbar**



auf 90° und 180°  
klappbar, schwere  
Ausführung



5 ltr.

### Rolltop-Chafing Dish „ELITE“



poliert, Rolltop-Deckel klappbar auf 90° und 180° + Speisenbehälter + Wasserbehälter inkl. Vorrichtung für Heizplatte + 1 Brennpastenbehälter, Hohlgriff kann nicht heiß werden, wechseln des Behälters ohne abnehmen des Deckels (kein Kondenswasser-Rücklaufsystem)

polished, rolltop cover adjustable at 90° and 180° + foodpan + 1 burner holder, waterpan with screws for heating unit (not included), change of the container without removing the lid (condensed water can not be led back into the waterpan)

pulido brillante, tapa rolltop a 90° o 180°, cubeta + 1 quemadores, cuba baño maría con fijaciones para resistencia (se sirve sin la resistencia), se puede cambiar la cubeta GN sin retirar la tapa, importante: el agua condensada no revierte en los alimentos

poli brillant, couvercle rolltop ouverture de 90° a 180°, bac, bain-marie avec 4 vis pour fixation résistance de chauffe amovible (non incluse), 2 brûleurs, le bac GN peut être retiré et remplacé sans démonter le couvercle, important: la condensation ne retombe pas sur les aliments

	□ cm	↑ cm	ltr.	€
12355 7	Ø 45	45	5	175,00

### Rolltop-Chafing Dish „HOME“



90°  
3,5 ltr.

180°

poliert, Rolltop-Deckel klappbar auf 90° und 180° + Speisenbehälter + Wasserbehälter + Brennpastenbehälter (kein Kondenswasser-Rücklaufsystem)

polished, rolltop cover adjustable at 90° and 180° + foodpan + waterpan + burner holder (condensed water can not be led back into the waterpan)

pulido brillante, tapa rolltop a 90° o 180°, cubeta + 2 quemadores, cuba baño maría, importante: el agua condensada no revierte en los alimentos

poli brillant, couvercle rolltop ouverture de 90° a 180°, bac, bain-marie, 2 brûleurs, important: la condensation ne retombe pas sur les aliments

	□ cm	↑ cm	ltr.	€
12340 3	Ø 36	38	3,5	94,00

### Elektro-Rolltop-Chafing Dish „ELITE“ electric rolltop chafing dish chafing dish eléctrico rolltop chafing dish électrique rolltop



6,8 ltr.

poliert, Rolltop-Deckel klappbar auf 90° und 180°, Elektro-Wasserbecken mit Temperaturregelung + Speisenbehälter, 220 - 240 V ~ 50 Hz; 420 - 500 W (kein Kondenswasser-Rücklaufsystem)

polished, rolltop cover adjustable at 90° and 180°, electric waterpan with adjustable heatcontrol + foodpan, voltage 220 - 240 V ~ 50 Hz, power consumption 420 - 500 W (condensed water cannot be led back into the waterpan)

pulido brillante, tapa abatible apertura a 90° o 180°, baño maría c/ termostato - 220-240 V-50 Hz. 420-500 W (el agua condensada no gotea dentro de la cubeta)

poli brillant, couvercle rolltop ouverture à 90° ou 180°, bain-marie électrique avec thermostat, 220-240 V - 50 Hz; 420-500 W (Important: la condensation ne retombe pas sur les aliments)

	□ cm	↑ cm	ltr.	€
12356 4	Ø 45	45	6,8	270,00

### Einzelteile / spare parts / piezas sueltas / pièces détachées

Speisenbehälter / foodpan / cubeta superior / bac supérieur

12357 1				38,00
---------	--	--	--	-------



inkl. GN1/1,  
100 mm, 14 ltr.

**Elektro-Rolltop-Chafing Dish „ELITE“**  
**electric rolltop chafing dish**  
**chafing dish eléctrico rolltop**  
**chafing dish électrique rolltop**



poliert, Rolltop-Deckel klappbar auf 90° und 180°, Elektro-Wasserbecken mit Temperaturregelung + Speisenbehälter GN1/1 100 mm tief, 220 - 240 V ~ 50 Hz; 760 - 900 W (kein Kondenswasser-Rücklaufsystem)

polished, rolltop cover adjustable at 90° and 180°, electric waterpan with adjustable heatcontrol + foodpan GN1/1 100 mm deep, voltage 220 - 240 V ~ 50 Hz, power consumption 760 - 900 W (condensed water cannot be led back into the waterpan)

pulido brillante, tapa abatible apertura a 90° o 180°, baño maría c/ termostato + cubeta GN 1/1 - 100 mm - 220-240 V-50 Hz. Consumo 760-900 W (el agua condensada no gotea dentro de la cubeta)

poli brillant, couvercle rolltop ouverture à 90° ou 180°, bain-marie électrique avec thermostat + bac GN1/1-100 mm, 220-240 V - 50 Hz; 760-900 W (Important: la condensation ne retombe pas sur les aliments)

	cm	cm	ltr.	€
12360 1	67 x 47	45	14	376,00



inkl. GN1/1,  
65 mm, 9 ltr.

**Elektro-Chafing Dish „ECO“ GN1/1**  
**electric chafing dish**  
**chafing dish eléctrico**  
**chafing dish électrique**



Deckel poliert, Elektro-Wasserbecken mit Temperaturregelung + Speisenbehälter GN1/1 65 mm tief, 220 - 240 V ~ 50 Hz; 760 - 900 W

cover polished, electric waterpan with adjustable heatcontrol + foodpan GN1/1 65 mm deep, voltage 220 - 240 V ~ 50 Hz, power consumption 760 - 900 W

tapa pulido brillante, baño maría c/ termostato + cubeta GN 1/1 - 65 mm - 220-240 V-50 Hz. / 760-900 W

couvercle poli brillant, bain-marie électrique avec thermostat + bac GN1/1-65 mm, 220-240 V - 50 Hz; 760-900 W

	cm	cm	ltr.	€
12232 1	63 x 36	29	9	125,00



6,8 ltr.

**Elektro-Chafing Dish „ECO“ rund**  
**electric chafing dish**  
**chafing dish eléctrico**  
**chafing dish électrique**



Glasdeckel (Rand poliert), Elektro-Wasserbecken mit Temperaturregelung + Speisenbehälter, 220 - 240 V ~ 50 Hz; 420 - 500 W

cover polished, electric waterpan with adjustable heatcontrol + foodpan, voltage 220 - 240 V ~ 50 Hz, power consumption 420 - 500 W

tapa vidrio borde pulido brillante, baño maría c/ termostato - 220-240 V-50 Hz. 420-500 W

couvercle verre bord poli brillant, bain-marie électrique avec thermostat, 220-240 V - 50 Hz; 420-500 W

	cm	cm	ltr.	€
12221 5	Ø 36	25	6,8	115,00



inkl. GN1/1,  
100 mm, 14 ltr.

**Elektro-Chafing Dish „INOXSTAR“**  
**electric chafing dish**  
**chafing dish eléctrico**  
**chafing dish électrique**



poliert, Thermostat-Regelung, Speisenbehälter GN1/1 100 mm tief, Deckelhalter, 900 W, 230 V

polished, thermostat control, foodpan GN1/1 100 mm deep, lid holder, 900 W, 230 V

pulido brillante, termostato de control, cubeta GN 1/1-100 mm, bloqueo para la tapa, 900 W, 230 V

poli brillant, thermostat, bac GN 1/1-100 mm, blocage du couvercle, 900 W, 230 V

	cm	cm	ltr.	€
12222 2	62 x 35	29	13,5	199,00

**Einzelteile / spare parts / piezas sueltas / pièces détachées**

Deckel / cover / tapa / couvercle

12235 2	30,00
---------	-------



inkl. GN1/1,  
100 mm, 14 ltr.

**Elektro Chafing Dish**  
**electric chafing dish**  
**chafing dish eléctrico**  
**chafing dish électrique**



Speisenbehälter GN1/1 100 mm tief, Deckelhalter, Thermostat-Regelung 900 W, 230 V

foodpan GN1/1 100 mm deep, lid holder, thermostat control 900 W, 230 V

cubeta GN 1/1-100 mm, sujeción de la tapa, termostato, 900W, 230 V

bac GN 1/1-100 mm, blocage du couvercle, thermostat, 900W, 230 V

	cm	cm	ltr.	€
12225 3	63 x 36	29	14	154,00

**Einzelteile / spare parts / piezas sueltas / pièces détachées**

Deckel / cover / tapa / couvercle

12235 2	30,00
---------	-------



2 x 4 ltr.

**Elektro-Suppenstation**  
**soup warmer**  
**chafing dish doble para sopa**  
**chafing dish 2 soupières**



2 Suppentöpfe + 2 Suppenkellen + Deckelhalter, Thermostat-Regelung (Überhitzungsschutz) 900 W, 230 V

2 soup pots + 2 soup ladles + lid holder, thermostat control 900 W, 230 V

incluye 2 ollas de sopa + 2 cucharones + bloqueo de la tapa, termostato 900 W, 230 V

2 marmites + 2 louches + blocage du couvercle + thermostat, 900 W, 230 V

	cm	cm	ltr.	€
12228 4	65 x 35,5	31	2 x 4	215,00



**Rolltop-Deckel „SWISS“**  
**rolltop-cover**  
**campana rolltop**  
**couvercle rolltop**



hochglanzpoliert, klappbar auf 90°, nachrüstbar für alle handelsüblichen Chafer

mirror polished finish, cover adjustable at 90°, usable for all commercial chafing dishes

pulido brillante, tapa ajustable 90°, apto para todos los chafings profesionales

poli brillant, ouverture réglable à 90°, apte pour tous les chafings professionnels

	cm	cm	€
12310 6	55 x 34	19,5	86,00





**Elektrischer Suppentopf**  
**electric soup warmer**  
**marmita de sopa eléctrica**  
**marmite à soupe électrique**



11902



**inklusive Schöpfkelle**

herausnehmbarer Einsatz aus Edelstahl, elektrisch, mit Wasserbad + Löffel + integrierter Tragering für den Innenbehälter, Deckel mit hitzeisolierendem Griff, Temperaturregelung 80°C (± 10°C), 450-550 W, 230 V

removable soup st. steel pan, bain marie electric, ladle, circular frame, thermostat control till 80°C (± 10°C), 450-550 W, 230 V

recipiente sopa inox extraíble, baño maria eléctrico + cucharón + aro inox, tapa con asas frías, termostato hasta 80°C precisión (± 10°C), 450-550 W, 230 V

réceptif à soupe inox amovible, bain-marie électrique, louche, support circulaire inox, thermostat maxi 80°C (± 10°C), 450-550 W, 230 V

	cm	cm	ltr.		€
11901 7	Ø 38	36,5	10	● schwarz / black	129,00
11902 4	Ø 38	36,5	10	● braun / brown	129,00

11901



**inklusive Schöpfkelle**



Chafing Dish  
chafing dish

**Bain-Marie Topf**  
**bain marie pot**  
**olla baño Maria**  
**marmite bain-marie**



inkl. Deckel, mit Löffelaussparung  
 included cover, notched for spoon  
 incluye tapa con hueco para la cuchara  
 inclut le couvercle avec espace pour la louche

	cm	cm	ltr.	€
12244 4	Ø 20	18	4,5	26,00

**Einzelteile / spare parts / piezas sueltas / pièces détachées**

Deckel / cover / tapa / couvercle

11244 5				7,50
---------	--	--	--	------



**Bain-Marie Deckel**  
**cover for bain marie**  
**tapa del baño maría**  
**couvercle du bain-marie**



	cm	€
12243 7	54 x 33,5	26,00



**Elektrischer Suppentopf**  
**electric soup warmer**  
**marmita de sopa eléctrica**  
**marmite à soupe électrique**



inkl. Schöpfkelle

herausnehmbarer Einsatz aus Edelstahl, elektrisch, mit Wasserbad + Löffel + integrierter Tragering für den Innenbehälter, Deckel mit hitzeisolierendem Griff, Temperaturregelung 80°C (± 10°C), 220 - 240 V

removable soup st. steel pan, bain marie electric, ladle, st. steel circular frame, thermostat control till 80°C (± 10°C), 220-240 V

recipiente sopa inox extraible, baño maria eléctrico + cucharón + aro inox, tapa con asas frías, termostato hasta 80°C precisión (±10°C) , 220-240 V

réipient à soupe inox amovible, bain-marie électrique, louche, support circulaire inox, thermostat maxi 80°C (± 10°C), 220-240 V

	cm	cm	ltr.		€
11910 9	Ø 40	37	10	220 - 240 V, 400 - 450 W	129,00

**Einzelteile / spare parts / piezas sueltas / pièces détachées**

Edelstahlgefäß / stainless steel pan / recipiente sopa inox / récipient à soupe inox

11911 6			10		50,00
---------	--	--	----	--	-------

Edelstahl-Deckel / stainless steel lid / tapa inox / couvercle inox

11912 3					31,00
---------	--	--	--	--	-------

Elektrokabel / electric cable / cable eléctrico / cable électrique

11913 0					14,00
---------	--	--	--	--	-------



**Elektrischer Suppentopf „ECONOMIC“**  
**electric soup warmer**  
**marmita de sopa eléctrica**  
**marmite à soupe électrique**



Stahl schwarz lackiert, herausnehmbarer Einsatz aus Edelstahl, Temperaturregelung 30°C - 90°C, dreh- und klappbarer Edelstahl-Deckel, inkl. 8 magnetisch haftenden Beschriftungen, 400 W / 230 V

metal, black, removable soup pot, thermostat 30°C - 90°C, st. steel lid, incl. 8 magnetic signs, 400 W / 230 V

metal negro, recipiente sopa inox extraible, termostato 30°C- 90°C, tapa inox, incluye 8 letreros magnéticos, 400 W / 230 V

acier, noir, récipient à soupe inox amovible, thermostat 30°C - 90°C, couvercle inox, 8 étiquettes magnétiques, 400 W / 230 V

	cm	cm	ltr.		€
11915 4	Ø 32	36	9		105,00

**Einzelteile / spare parts / piezas sueltas / pièces détachées**

Speisenbehälter / foodpan / recipiente sopa / récipient à soupe

11916 1					23,00
---------	--	--	--	--	-------

Deckel / cover / tapa / couvercle

11917 8					14,90
---------	--	--	--	--	-------

mit Deckel-  
Bajonettverschluss



**Brennpastenbehälter**  
burner holder  
quemador  
brûleur



mit Bajonettverschluss  
bayonet lock  
cierre de bayoneta  
verrouillage par baïonnette



	□ cm	↑ cm	€
11683 2	Ø 9	6	6,00



00100

**Sicherheitsbrenner „HOT & SAFE“**  
refillable burner  
quemador recargable  
brûleur rechargeable



speziell für den Einsatz von „HOT & SAFE“ Brennflüssigkeit (Pat. Nr. 00108134), für jeden Chafing-Dish geeignet, verbrennt zu 100%, besonders sparsam, minimale Geruchsentwicklung, Brennflüssigkeit kann nicht auslaufen, Brenndauer pro Füllung à 200 ml: 2 bis 2,5 Stunden.

A special splash guard prevents any unintentional fuel leakage. An adabter ring allows you to use the burner in any type of chafing dish equipment. Since the new fuel burns cleanly, no soot or smoke is produced. Since more intense heat is generated than with conventional fuel paste, your foods remain hot longer, the fuel is easy to measure, non-toxic. à 200 ml: 2 to 2,5 hours.

Muy seguro y sano: borde anti-salpicadura, aro adaptador para cualquier tipo de chafing dish. El combustible se quema de forma limpia, sin humo ni residuos. Ahorro: El calor desprendido es más intenso que con otros combustibles convencionales, manteniendo los platos calientes más tiempo. Fácil de rellenar, no tóxico. 200 ml duran de 2 a 2,5 horas.

Chaleur saine en toute sécurité. Bord anti-éclaboussures. Anneau adaptateur pour tous les types de chafing dish. Le combustible brûle sans émettre ni fumée ni suie. Economique: La chaleur est plus intense qu'avec les autres combustibles conventionnels et maintient donc les plats chauds plus longtemps. Facile à recharger. 200 ml durent de 2 à 2,5 heures.

**Große Sicherheit,  
da Brennflüssigkeit  
nicht auslaufen kann.  
Unfallsicher!**

00208

**Absolut  
ungiftig!**



00100

	□ cm	↑ cm	€
00100 8	Ø 9	6	12,00

**Flasche Brennflüssigkeit**  
bottle fuel  
botella de combustible líquido  
bouteille de combustible liquide

	ltr.	€
00208 1	1	5,80

Chafing Dish  
chafing dish



CE  
SCHOTT  
glass made of ideas

**Einbau-Induktionskochplatte für Chafing Dish**  
**built-in induction plate for chafing dish**  
**placa de inducción para empotrar**  
**plaque à induction à encastrer**



inkl. Kabel-Fernbedienung, energiesparend  
 plug EU, voltage 230 VAC  
 enchufe EU, voltaje 230 VAC  
 prise Europe, voltage 230 VAC

	cm	cm		€
12285 7	35,5 x 35,5	6	2000 W	199,00



CE  
SCHOTT  
glass made of ideas

**Induktionskochplatte für Chafing Dish**  
**induction plate for chafing dish**  
**placa de inducción para chafing dish**  
**plaque à induction pour chafing dish**



mit Regler, kann nur in Verbindung mit passendem Metallrahmen genutzt werden  
 with power control, can only be used with the fitting frame for induction plate  
 con control de potencia, sólo puede usarse con el marco para placa de inducción  
 avec régulateur, à utiliser obligatoirement avec le cadre support inox

	cm		€
12295 6	Ø 24	900 W	129,00

**Metallrahmen für Induktionskochplatte**  
**frame for induction plate**  
**estructura o marco para placa de inducción**  
**cadre support inox pour plaque induction**

für GN1/1 Chafing Dish / for GN1/1 chafing dish  
 para GN 1/1 chafing dish / pour chafing GN 1/1



12296 3			18,00
---------	--	--	-------

für Chafer rund, Suppenkugel / for chafing dish, round  
 para chafing dish redondo / pour chafing dish rond

12291 8			17,00
---------	--	--	-------



**Hot Plate „ECONOMIC“**  
**hot plate**  
**placa caliente**  
**plaque chaude**



automatische Temperaturregelung, die Alu-Heizplatte ist in ca. 5 Minuten auf ca. 75°C erhitzt und hält Speisen auf konstanter Temperatur, CE-Zeichen  
 with automatic power supply, gets up to 75°C in 5 minutes, keeps food on continuous temperature

control automático de temperatura, mantiene los alimentos en temperatura constante, la placa de aluminio llega a 75° C en aprox. 5 min.

contrôle automatique de température, maintient les aliments à température constante sur la plaque aluminium, monté à 75°C en 5 min. approx.

	cm	GN	€
11920 8	53 x 32,5	1/1	174,00



**Elektro-Heizelement**  
**heating unit**  
**resistencia**  
**résistance**

12290



für mehrheitlich **geschlossene** Chafer GN1/1  
 for GN1/1 chafer covers are closed most of the time  
 para chafing dish GN1/1 casi siempre cerrados  
 pour chafing dish GN1/1 qui restent habituellement fermés

12290 1	360 W - 140-250 V	€ 116,00
---------	-------------------	----------

12292



für mehrheitlich **geöffneten** Chafing Dish GN1/1  
 for GN1/1 chafer covers open most of the time  
 para chafing dish GN1/1 con la tapa casi siempre abierta  
 pour chafing dish GN 1/1 dont le couvercle reste souvent ouvert

12292 5	600 W - 230 V	€ 120,00
---------	---------------	----------

12294



für mehrheitlich **geöffnete** Chafer GN1/1 mit **einstellbarem Leistungsregler**  
 for GN1/1 chafer covers are opened most of the time, with adjustable control  
 para GN 1/1 chafing dish abiertos, con termostato  
 pour chafing dish GN1/1 qui restent habituellement ouverts, avec thermostat

12294 9	800 W - 230 V	€ 154,00
---------	---------------	----------



**passendes Heizelement**  
**wird in das Gestell**  
**ingelegt, regelbar**

für Kaffeedispenser (Nr. 11672)  
 for coffee dispenser (no. 11672)  
 para dispensador de café (11672)  
 pour distributeur à café (11672)

12287 1	500 W - 220 V	€ 98,00
---------	---------------	---------

Chafing Dish  
chafing dish

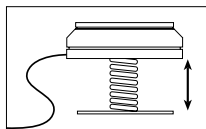

**Mobile Chafing Dish Heizung**  
**heating element**  
**resistencia**  
**résistance**



für alle marktgängigen Chafing Dishes, die Heizplatte wird durch eine Spiralfeder an das Wasserbad gedrückt  
 suitable for all current popular chafing dishes, with special spring  
 para todos los chafing dish más corrientes  
 pour la plupart des chafing dish les plus courants

	□ cm	↑ cm	€
12299 4	14	9 - 11	81,00



**Wärme-Kies**  
**granite chips**  
**granulado térmico**  
**gravier thermique**

für Chafing Dishes, feine Körnung, hohe Wärmespeicherung, kein Verkleben, ideal zum Warmhalten von Eiern

fine for chafing dishes and clean granite chippings, ideal for keeping eggs warm

gravilla de granito fina limpia, ideal para mantener los huevos calientes

gravier fin de granit, lavé, idéal pour maintenir les oeufs au chaud



7 kg Eimer

kg

€

81116 4

7

19,00

**Chafing Dish „VEGGIE“**



4 Liter

Speisenbehälter + Wasserbecken + 1 Brennpastenbehälter + Deckel + Gestell

foodpan + waterpan + 1 burner holder + cover + frame

cubeta redonda + baño maría + quemador + tapa + soporte

réipient + bain marie + brûleur + couvercle + support

cm

↑ cm

ltr.

€

11693 1

Ø 35

28

4

39,00



Glasdeckel  
 glass cover



praktischer Halter  
 für den Deckel /  
 included cover holder



**Servierschale „FEUERZANGENBOWLE“**  
**warmer**  
**calentador para quemada**  
**chauffe-plat spécial sucre flambé**



Stövchen verchromt, Edelstahl-Deckel hochglanzpoliert, Kelle und Zuckerhutablage aus Edelstahl, ohne Zuckerhut

frame chrome plated, stainless cover mirror polished finish, incl. ladle and sugar holder

especial para preparar bebidas calientes, con azúcar o quemadas, redondo, pie cromado, incluye cucharón y soporte para el bloque de azúcar.

spécial pour la préparation de boissons chaudes, pied chromé, inclut la louche et le support à sucre

cm

↑ cm

ltr.

€

65065 7

Ø 23

26

4

36,00

**Feuerzange / fire tong / soporte para quemada / support pour flamber**

65066 4

31 x 7

4,40



**Servierschale mit Stövchen „HOT POT“  
warmer  
calienta platos  
chauffe-plat**



Stövchen verchromt, Edelstahl-Deckel hochglanzpoliert, inkl. Schöpfkelle  
frame chrome plated, stainless cover mirror polished finish, incl. ladle  
cacerola de vidrio termoresistente, soporte cromado, tapa con pulido brillante, apto para horno  
bol en verre thermo-résistant, pied chromé, couvercle brillant, apte pour cuisson au four

	□ cm	↑ cm	ltr.	€
65035 0	Ø 23	26	4	31,00

**Einzelteile / spare parts / piezas sueltas / pièces détachées**

Ersatz-Glaseinsatz / spare glass / fuente de recambio vidrio / plat de rechange en verre

64201 0			4	13,00
---------	--	--	---	-------



65010

**Servierschale mit Stövchen  
warmer  
calienta platos  
chauffe-plat**



feuerfeste Glasschale, Stövchen verchromt, Deckel hochglanzpoliert, Backofen geeignet  
glas bowl fireproof, frame chrome plated, cover mirror polished finish, suitable for oven  
fuente de vidrio termoresistente, soporte cromado, tapa con pulido brillante, apto para horno  
plat en verre thermo-résistant, pied chromé, couvercle brillant, apte pour cuisson au four

	□ cm	↑ cm	ltr.	€
65010 7	47 x 24	13	3	32,00
65020 6	44 x 25	13	3	32,00
65030 5	45 x 29	12	2 x 1,5	36,00



65020

**Einzelteile / spare parts / piezas sueltas / pièces détachées**

Ersatz-Glaseinsatz / spare glass / fuente de recambio vidrio / plat de rechange en verre

64001 6	für / for / para 65010	3	12,90
64051 1	für / for / para 65020	3	12,90
64151 8	für / for / para 65030	1,5	9,20



65030



65033

**Servierschale mit Stövchen  
warmer  
calienta platos  
chauffe-plat**



feuerfeste Glasschale, Stövchen verchromt, Deckel hochglanzpoliert, Backofen geeignet  
glas bowl fireproof, frame chrome plated, cover mirror polished finish, suitable for oven  
fuente de vidrio termoresistente, soporte cromado, tapa con pulido brillante, apto para horno  
plat en verre thermo-résistant, pied chromé, couvercle brillant, apte pour cuisson au four

	□ cm	↑ cm	ltr.	€
65033 6	Ø 26	22	2	19,00
65034 3	29,5 x 18	12	1,5	22,00



65034

**NEW****Ausgießlippe**

**Butter- und Saucenwärmer**  
**butter- and sauce pan warmer**  
**calentador de mantequilla y salsa**  
**réchaud à beurre et sauce**



Saucentopf mit Ausgießer + Deckel + Gestell (passend für 1 Teelicht)  
 pan with spout + lid + riser (for 1 light)  
 cacerola + tapadera + soporte (para 1 vela)  
 petite casserole avec bec verseur + couvercle + support (pour 1 bougie)

	☐ cm	↑ cm	ltr.		€
35350 3	Ø 14	16	0,7	Griff: 13,5 cm / handle: 13,5 cm asa: 13,5 cm / poignée: 13,5 cm	15,00

**Speisenwärmer „PROFI“**  
**plate warmer**  
**calienta platos**  
**chauffe-plat**



Rahmen aus Edelstahl mit Aluminium-Wärmeplatte  
 stainless steel frame, thick aluminium plate  
 soporte inox con placa de aluminio  
 support inox avec plaque aluminium

	☐ cm	↑ cm		€
35050 2	33 x 18	7	2 Teelichter / 2 tealights 2 velas / 2 bougies	41,00
35070 0	45 x 18	7	3 Teelichter / 3 tealights 3 velas / 3 bougies	54,60

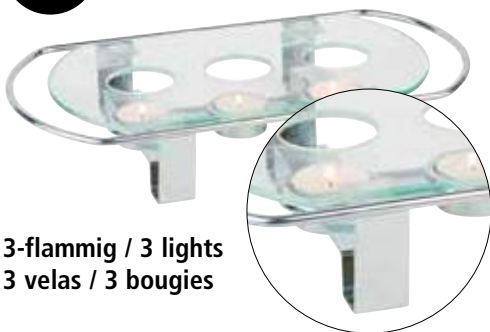
**HOT PRICE**

**3-flammig / 3 lights**  
**3 velas / 3 bougies**

**Speisenwärmer**  
**warmer**  
**calienta platos**  
**chauffe-plat**



3-flammig  
 3 lights  
 3 velas  
 3 bougies

	☐ cm	↑ cm		€
35065 6	34 x 18	6		17,00

**HOT PRICE**

**Speisenwärmer**  
**warmer**  
**calienta platos**  
**chauffe-plat**



2-flammig, matt poliert  
 2 lights, satin polished finish  
 2 velas, acero inoxidable acabado mate  
 2 bougies, inox finition mate

	☐ cm	↑ cm		€
35343 5	34 x 13	6		13,00



GN . GN-Zubehör . GN-Behälter . Transport . Vorrat . Thermobox  
GN . GN-extras . GN-container . transport . store . thermobox  
GN . GN-extras . GN-cubeta . transporte y almacenaje . thermobox  
bacs et accessoires GN . transport et stockage . thermobox

### GN-Behälter Größen nach EN 631

Alle Behälter sind aus rostfreiem Chrom-Nickel-Edelstahl mit elektrolytisch polierter (seidenmatt) Oberfläche und somit perfekt geeignet für professionellen Einsatz.

### GN-container according to EN 631

All pans are made of chrome/nickel stainless steel with a surface polished by electrolysis (satin-matt) and therefore highly suitable for professional operation.

### De conformidad con la norma europea EN 631

Todos los contenedores están fabricados en acero inoxidable cromado/niquelado con su superficie (satinada) pulida por electrolisis lo que la hace altamente apropiado para el uso profesional.

### Bacs GN- Conforme à la norme EN 631

Tous les bacs sont fabriqués en inox/chrome/nickel, surface polie électrolythique (satiné). Approprié pour usage professionnel.

### Vorteile der rundgeprägten U-Ecken:

- erhöhte Stabilität durch verstärktes Profil
- zielgerechtes und sauberes Ausgießen
- genaue Positionierung der GN-Behälter
- superleichtes Stapeln und Entstapeln
- kein Verklemmen der GN-Behälter
- hohe Stoßfestigkeit durch robuste Konstruktion
- ansprechendes Design und stilvoller Blickfang

### Advantages of the round-shaped U-Corners:

- increased stability due to the unique construction
- clean ladling and pouring
- exact positioning of the containers
- improved shock-resistance
- appealing design
- no seize of the containers

### Ventajas de las esquinas en U:

Perfil reforzado que confiere mayor rigidez y resistencia a la cubeta, diseño para verter fácil y limpiamente, fáciles de apilar y desapilar sin que se claven entre sí, construcción más robusta y resistente a los golpes mecánicos, diseño elegante.

### Avantages et fonctionnalité des angles en U:

Profil renforcé pour une meilleure consistance et rigidité du récipient, design qui facilite un versage propre et aisé, permet un empilage et désempilage faciles sans que les bacs restent coincés, meilleure résistance aux chocs mécaniques, seign élégant.

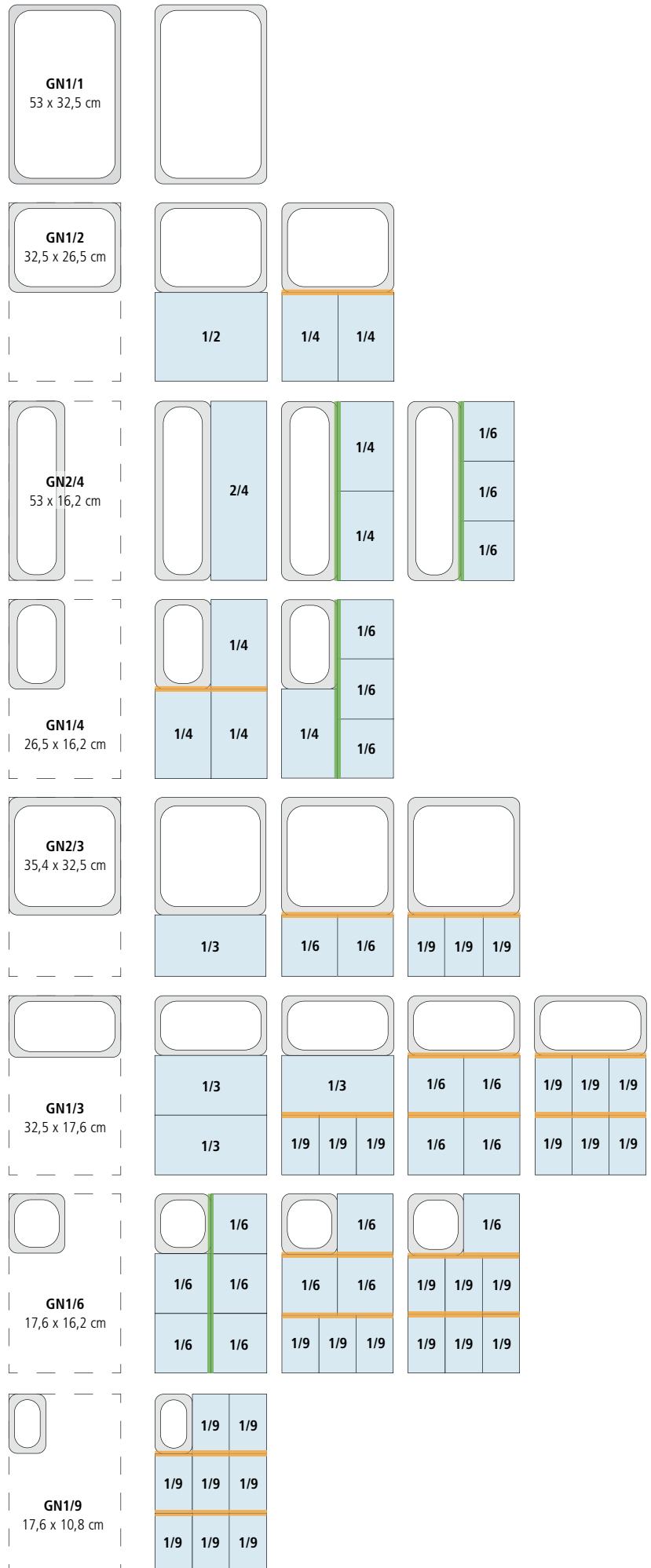



**GastroNorm-Behälter**  
**gastronorm-container**  
**cubetas gastronorm**  
**bacs gastronorme**

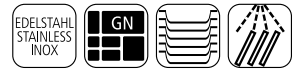

	GN	↓ mm	litr.	€
81000 6	2/1	20	5,0	33,10
81095 2	1/1	10	1,25	11,90
81100 3	1/1	20	2,5	13,30
81101 0	1/1	40	5,0	15,00
81109 6	1/1	55	6,5	15,60
81102 7	1/1	65	9,0	15,85
81104 1	1/1	100	13,25	19,60
81106 5	1/1	150	20,0	29,50
81108 9	1/1	200	28,0	35,65
81200 0	1/2	20	1,0	5,40
81201 7	1/2	40	2,0	8,15
81209 3	1/2	55	2,8	8,40
81202 4	1/2	65	4,0	8,65
81204 8	1/2	100	6,0	11,75
81206 2	1/2	150	8,75	18,50
81208 6	1/2	200	11,65	23,90
81300 7	1/3	20	0,75	4,20
81302 1	1/3	65	2,5	6,60
81304 5	1/3	100	4,0	9,25
81306 9	1/3	150	5,7	12,60
81308 3	1/3	200	7,0	16,70
81400 4	1/4	20	0,5	4,40
81401 1	1/4	40	1,0	5,00
81402 8	1/4	65	1,8	6,00
81404 2	1/4	100	2,8	7,90
81406 6	1/4	150	4,0	12,10
81408 0	1/4	200	5,5	15,10
81602 2	1/6	65	1,0	4,30
81604 6	1/6	100	1,6	6,00
81606 0	1/6	150	2,4	9,60
81608 4	1/6	200	3,0	11,90
81502 5	1/9	65	0,6	3,10
81504 9	1/9	100	1,0	4,80
81506 3	1/9	150	1,5	6,85
81700 5	2/3	20	1,5	9,50
81701 2	2/3	40	3,0	12,60
81702 9	2/3	65	5,5	14,60
81704 3	2/3	100	8,4	19,20
81706 7	2/3	150	12,5	27,85
81707 4	2/3	200	18,0	30,00
81800 2	2/4	20	1,2	8,00
81801 9	2/4	40	2,4	10,50
81802 6	2/4	65	3,6	12,25
81804 0	2/4	100	5,6	17,15
81806 4	2/4	150	8,7	20,00

**Vorteile der rundgeprägten U-Ecken:**

- erhöhte Stabilität durch verstärktes Profil
- zielgerechtes und sauberes Ausgießen
- genaue Positionierung der GN-Behälter
- superleichtes Stapeln und Entstapeln
- kein Verkleben der GN-Behälter
- hohe Stoßfestigkeit durch robuste Konstruktion
- ansprechendes Design und stilvoller Blickfang

**Advantages of the round-shaped U-Corners:**

- increased stability due to the unique construction
- clean ladling and pouring
- exact positioning of the containers
- improved shock-resistance
- appealing design
- no seize of the containers

**EN 631 Gastronorm**  cm

GN2/1	53,0 x 65,0
GN1/1	53,0 x 32,5
GN1/2	32,5 x 26,5
GN1/3	32,5 x 17,6
GN1/4	26,5 x 16,2
GN1/6	17,6 x 16,2
GN1/9	17,6 x 10,8
GN2/3	35,4 x 32,5
GN2/4	53,0 x 16,2



**perforierte GN-Behälter  
perforated GN-container  
cubetas GN perforadas  
bacs GN perforés**



	GN	↓ mm	€
81911 5	1/1	40	15,60
81907 8	1/1	65	15,85
81908 5	1/1	100	19,60
81909 2	1/1	150	29,50
81910 8	1/1	200	35,65
81901 6	1/2	65	8,65
81902 3	1/2	100	11,75
81903 0	1/2	150	18,50
81904 7	1/2	200	23,90
81905 4	2/3	65	14,60
81906 1	2/3	100	19,20



**GN-Deckel  
GN-lids  
tapas GN  
couvertres GN**



ohne Löffelaussparung  
without notched edge for spoons  
sin agujero para cucharón  
sans espace pour louche

	GN	€
81195 9	1/1	12,25
81295 6	1/2	6,25
81395 3	1/3	4,70
81495 0	1/4	4,45
81695 4	1/6	2,50
81591 9	1/9	2,65
81795 1	2/3	13,50
81895 8	2/4	9,70



mit Löffelaussparung  
with notched edge for spoons  
con agujero para cucharón  
avec espace pour louche

81191 1	1/1	13,30
81292 5	1/2	7,00
81391 5	1/3	5,30
81492 9	1/4	5,00
81692 3	1/6	2,95
81595 7	1/9	2,80
81791 3	2/3	14,60
81891 0	2/4	10,80

**mit Löffelaussparung  
with notched edge for spoons**



**Adapter / Zwischensteg  
adapter  
adaptador  
adaptateur**



Schiene ermöglicht stabilen Halt von GN-Behältern im Chafing Dish, rostfreier Chrom-Nickel-Edelstahl  
for fixing GN pans, chrome / nickel stainless steel  
para sujetar las cubetas GN, acero inox  
support stable pour les bacs GN

	cm		€
81997 9	17,6	längs bei GN 1/9 / lengthwise GN 1/9 longitud GN 1/9 / GN 1/9 dans la longueur	1,40
81999 3	32,5	quer bei GN 1/2 / crosswise GN 1/2 de ancho GN 1/2 / GN 1/2 dans la largeur	2,65
81998 6	53	längs bei GN 1/1 / lengthwise GN 1/1 longitud GN 1/1 / GN 1/1 dans la longueur	4,70

**schwappssicherer Deckel**



**Nicht für Kombidämpfer geeignet!  
Max. 100°C**

**GN Transport-Steck-Deckel  
GN-lid with silicone seal  
tapa GN hermética con junta  
couvercle GN hermétique avec joint**

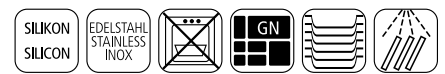

Silikondichtung, Griffmulde und Loch gegen Unterdruck, nicht für Kombidämpfer geeignet, nicht für ≤ 65 mm tiefe GN-Behälter

silicone joint, flat handle, vent to compensate for pressure, not usable for steam oven, not usable for ≤ 65 mm depth GN-pans

junta de silicona, asa empotrada, válvula para compensar la presión, no se puede utilizar en hornos de vapor, ni para cubetas de altura ≤ 65 mm

joint silicone, anse encastrée, valve pour compenser la pression, ne pas utiliser pour les fours à vapeur ni pour les bacs hauteur ≤ 65 mm

	GN	€
80023 6	1/1	29,00
80024 3	1/2	18,00
80025 0	1/3	15,70
80026 7	1/4	13,50
80027 4	1/6	11,00



**GN-Behälter mit Fallgriff  
GN-pans with falling handles  
GN cubetas con asas abatibles  
bacs GN avec anses abattantes**



runder ergonomischer Fallgriff

round ergonomic handles

asas redondeadas ergonómicas

anses ergonomiques arrondies



**in 3 Tiefen erhältlich  
65, 100 und 150 mm**

	GN	↓ mm	ltr.	€
82502 4	1/1	65	9	19,20
82504 8	1/1	100	14	23,90
82506 2	1/1	150	21	35,90
82508 6	1/2	65	4	12,60
82510 9	1/2	100	6,5	15,00
82512 3	1/2	150	9,5	23,90
82514 7	1/3	65	2,5	9,30
82516 1	1/3	100	4	12,60
82518 5	1/3	150	5,7	17,40
82520 8	2/3	65	5,5	16,80
82522 2	2/3	100	9	21,60
82524 6	2/3	150	13	28,80

**GN-Deckel mit Ausschnitt  
passend zu GN-Behältern  
mit Fallgriff.**



**GN-Deckel mit Ausschnitt  
GN-lid with cut out  
tapa para cubetas GN  
couvercle pour bacs GN**



	GN	€
82526 0	1/1	14,40
82528 4	1/2	8,40
82530 7	1/3	6,00
82532 1	2/3	11,40



**GN-Deckel, luftdicht  
GN-cover, airtight  
tapa GN hermética  
couvercle hermétique GN**



temperaturbeständig -40°C bis +95°C  
temperature resistance from -40°C up to +95°C  
resistente a temperaturas entre - 40°C hasta + 95°C  
apte pour température entre - 40°C et + 95°C

	GN	€
80021 2	1/1	7,50
80022 9	1/2	5,00

**GN1/1 und  
GN1/2**



88248

**Antihaft GN-Konvektomatenblech  
GN-convection oven trays - non stick  
cubeta GN antiadherente para hornos de convección  
bac GN anti-adhérent pour fours à convection**



Oberfläche mit schwarzer Antihaftbeschichtung, schwere Qualität  
coated black non stick, heavy quality  
interior con revestimiento antiadherente negro, alta calidad  
revêtement intérieur antiadhérent noir, haute qualité

	GN	cm	↑ cm	€
88246 1	1/1	53,0 x 32,5	2	36,60
88247 8	1/1	53,0 x 32,5	4	42,90
88248 5	1/1	53,0 x 32,5	6,5	49,00
88249 2	1/2	26,5 x 32,5	1	24,00
88250 8	1/2	26,5 x 32,5	2	28,00

**GN1/1**



88245

**GN-Konvektomatenblech - Emailliert  
GN-convection oven trays - enamelled  
cubeta GN esmaltada para hornos de convección  
bac GN émaillé pour fours à convection**



beidseitig beschichtet mit schwarzer Granit-Emaille, gelochte Ecken, schwere Qualität  
both sides coated with black granite enamel, perforated rim corners, heavy gauge  
chapa de hierro esmaltada por ambas caras, color granito negro, borde con ángulos perforados, alta calidad  
plaque acier émaillé intérieur et extérieur, granité noir, bord perforé dans les angles, qualité renforcée

	GN	cm	↑ cm	€
88244 7	1/1	53 x 32,5	2	23,80
88144 0	1/1	53 x 32,5	4	26,50
88245 4	1/1	53 x 32,5	6,5	28,60

**Backblech**  
baking sheet  
bandeja pastelera  
plaque à pâtisserie



gelocht Ø 3 mm, Materialstärke 1,5 mm, Silikon beschichtet, temperaturbeständig bis 240°C  
perforated Ø 3 mm, coated with silicon, heat resistant up to 240°C  
aluminio con revestimiento de silicona perforada, resistente hasta 240°  
aluminium avec revêtement silicone, perforée, température maxi 240°

	GN	cm	€
88285 0	1/1	53 x 32,5	29,80



**GN-Roste**  
GN-grid  
rejilla GN  
grille inox



elektrolytisch poliert, Drahtstärke 3 mm, Rahmendraht 6 mm, extra schwere Qualität  
electro-polished, wire thickness 3 mm, frame wire 6 mm, extra heavy quality  
inox pulido electrolítico, grosor alambre 3 mm, grosor marco 6 mm, calidad reforzada  
inox poli électrolytique, fil 3 mm, cadre 6 mm, qualité renforcée

	GN	cm	€
81199 7	2/1	65,0 x 53,0	41,00
81198 0	1/1	53,0 x 32,5	18,90
81296 3	1/2	32,5 x 26,5	10,00
81796 8	2/3	32,5 x 35,4	12,50

**Bestecksammler GN1/3**  
container GN1/3  
cubeta GN1/3  
bac GN1/3



mit 2 Haken zum Einhängen an Servier- oder Transportwagen  
container with 2 hooks, to hang on trolleys for cutlery  
cubeta con 2 ganchos para cubiertos, a colgar del carro  
bac à couverts avec 2 crochets, à accrocher au chariot

	GN	cm	cm	€
11978 9	1/3	32,5 x 17,5	15	18,00

**GN-Behälter aus Polycarbonat**  
**GN-container polycarbonate**  
**cubeta GN policarbonato**  
**bac GN polycarbonate**



transparent: Inhalt gut erkennbar, Skalierung in Liter, robust und formstabil  
 transparent: content can be seen, liter scale, solid quality  
 transparente para ver el contenido, graduación en litros, alta calidad  
 transparent pour voir le contenu, graduation en litres, haute-qualité

**EN 631 Gastronorm** cm

GN1/1	53,0 x 32,5
GN1/2	32,5 x 26,5
GN1/3	32,5 x 17,6
GN1/4	26,5 x 16,2
GN1/6	17,6 x 16,2
GN1/9	17,6 x 10,8

	GN	↓ mm	ltr.	€	
82004	3	1/1	65	8,5	13,40
82006	7	1/1	100	13,0	15,40
82008	1	1/1	150	19,5	19,00
82010	4	1/1	200	26,0	25,00
<hr/>					
82012	8	1/2	65	3,9	6,40
82014	2	1/2	100	5,9	7,80
82016	6	1/2	150	8,9	9,60
82017	3	1/2	200	11,8	13,00
<hr/>					
82018	0	1/3	65	2,4	5,40
82020	3	1/3	100	3,6	6,40
82022	7	1/3	150	5,3	7,80
82023	4	1/3	200	7,0	9,60
<hr/>					
82028	9	1/4	65	1,7	4,20
82030	2	1/4	100	2,5	5,00
82032	6	1/4	150	3,7	8,00
82034	0	1/4	200	5,5	9,90
<hr/>					
82036	4	1/6	65	1,0	3,60
82038	8	1/6	100	1,5	3,90
82040	1	1/6	150	2,2	4,80
82042	5	1/6	200	3,4	6,80
<hr/>					
82050	0	1/9	65	0,6	2,60
82051	7	1/9	100	1,0	3,00



82029  
GN1/4

**GN-Deckel**  
**GN-lid**  
**tapa GN**  
**couverture GN**



	GN	€	
82001	2	1/1	9,00
82013	5	1/2	5,00
82019	7	1/3	4,00
82029	6	1/4	3,20
82037	1	1/6	2,50
82059	3	1/9	2,20



82005  
GN1/2

**GN-Abtropfgitter**  
**GN-drainer**  
**escurridor GN**  
**égouttoir GN**



	GN	€	
82003	6	1/1	6,60
82005	0	1/2	3,60
82007	4	1/3	2,90





82117



**GN-Behälter aus Polypropylen**  
**GN-container polypropylene**  
**cubetas GN polipropileno**  
**bacs GN en polypropilène**



milchig (nicht transparent), Skalierung in Liter, robust und formstabil

frosted, Liter scale, solid quality

translúcido opaco, graduación en litros, muy resistente a la deformación, robusto

translucide opaque, graduation en litres, très résistant à la déformation, robuste

	GN	↓ mm	ltr.	€
82104 0	1/1	65	8,5	7,60
82106 4	1/1	100	13,0	8,80
82108 8	1/1	150	19,5	10,00
82110 1	1/1	200	26,0	12,50
82112 5	1/2	65	3,9	4,10
82114 9	1/2	100	5,9	4,80
82116 3	1/2	150	8,9	5,80
82117 0	1/2	200	11,8	6,80
82118 7	1/3	65	2,4	3,40
82120 0	1/3	100	3,6	4,00
82122 4	1/3	150	5,3	5,20
82123 1	1/3	200	7,0	6,00
82128 6	1/4	65	1,7	2,90
82130 9	1/4	100	2,5	3,20
82132 3	1/4	150	3,7	4,40
82134 7	1/4	200	5,5	6,90
82136 1	1/6	65	1,0	2,40
82138 5	1/6	100	1,5	2,80
82140 8	1/6	150	2,2	3,20
82142 2	1/6	200	3,4	5,80
82150 7	1/9	65	0,6	2,20
82151 4	1/9	100	1,0	2,40

**GN-Behältern aus Polypropylen**  
**sind auch stapelbar mit**  
**APS GN-Behältern aus Polycarbonat**



82113  
GN1/2

**GN-Deckel**  
**GN-lid**  
**tapa GN**  
**couvercle GN**



	GN	€
82101 9	1/1	4,30
82113 2	1/2	2,50
82119 4	1/3	2,10
82129 3	1/4	2,00
82137 8	1/6	1,90
82159 0	1/9	1,80

**HOT  
PRICE**

**GN-Behälter „ECOLINE“**  
GN container  
cubeta GN superior  
bac GN supérieur



**Melamin**

mit Stapelnocke  
with notching edge  
con borde marcado para el apilado  
avec rebord pour l'empilage



**GN1/1**  
83759 65 mm  
84300 100 mm



**GN1/2**  
83756 65 mm  
84307 100 mm



**GN2/4**  
83755 65 mm  
84302 100 mm



**GN1/3**  
83752 65 mm  
84303 100 mm



**GN1/4**  
83751 65 mm  
84304 100 mm



**GN1/6**  
83748 65 mm  
84311 100 mm

	GN	↓ mm	ltr.	□ cm		€	
	83759 1	1/1	65	7,10	53,0 x 32,5	○	28,00
	83757 7	1/2	65	3,40	32,5 x 26,5	○	15,80
	83755 3	2/4	65	3,00	53,0 x 16,2	○	19,00
	83753 9	1/3	65	2,00	32,5 x 17,6	○	13,80
	83751 5	1/4	65	1,35	26,5 x 16,2	○	12,50
	83749 2	1/6	65	0,80	17,6 x 16,2	○	10,00
	83758 4	1/1	65	7,10	53,0 x 32,5	●	28,00
	83756 0	1/2	65	3,40	32,5 x 26,5	●	15,80
	83754 6	2/4	65	3,00	53,0 x 16,2	●	19,00
	83752 2	1/3	65	2,00	32,5 x 17,6	●	13,80
	83750 8	1/4	65	1,35	26,5 x 16,2	●	12,50
	83748 5	1/6	65	0,80	17,6 x 16,2	●	10,00
	84300 4	1/1	100	10,6	53,0 x 32,5	○	33,00
	84301 1	1/2	100	4,7	32,5 x 26,5	○	19,50
	84302 8	2/4	100	4,3	53,0 x 16,2	○	24,00
	84303 5	1/3	100	2,7	32,5 x 17,6	○	15,50
	84304 2	1/4	100	1,9	26,5 x 16,2	○	14,00
	84305 9	1/6	100	1,0	17,6 x 16,2	○	10,50
	84306 6	1/1	100	10,6	53,0 x 32,5	●	33,00
	84307 3	1/2	100	4,7	32,5 x 26,5	●	19,50
	84308 0	2/4	100	4,3	53,0 x 16,2	●	24,00
	84309 7	1/3	100	2,7	32,5 x 17,6	●	15,50
	84310 3	1/4	100	1,9	26,5 x 16,2	●	14,00
	84311 0	1/6	100	1,0	17,6 x 16,2	●	10,50

passende PC-Deckel, Seite 304  
suitable PC-cover, page 304



**GN1/1**

**Porzellan**

**GN-Behälter**  
GN-container  
cubetas GN  
bac GN



	GN	↑ cm	□ cm	€	
	82100 2	1/1	6,5	53,0 x 32,5	48,00
	82200 9	1/2	6,5	32,5 x 26,5	22,00
	82300 6	1/3	6,5	32,5 x 17,6	17,00



# HIGHLINE

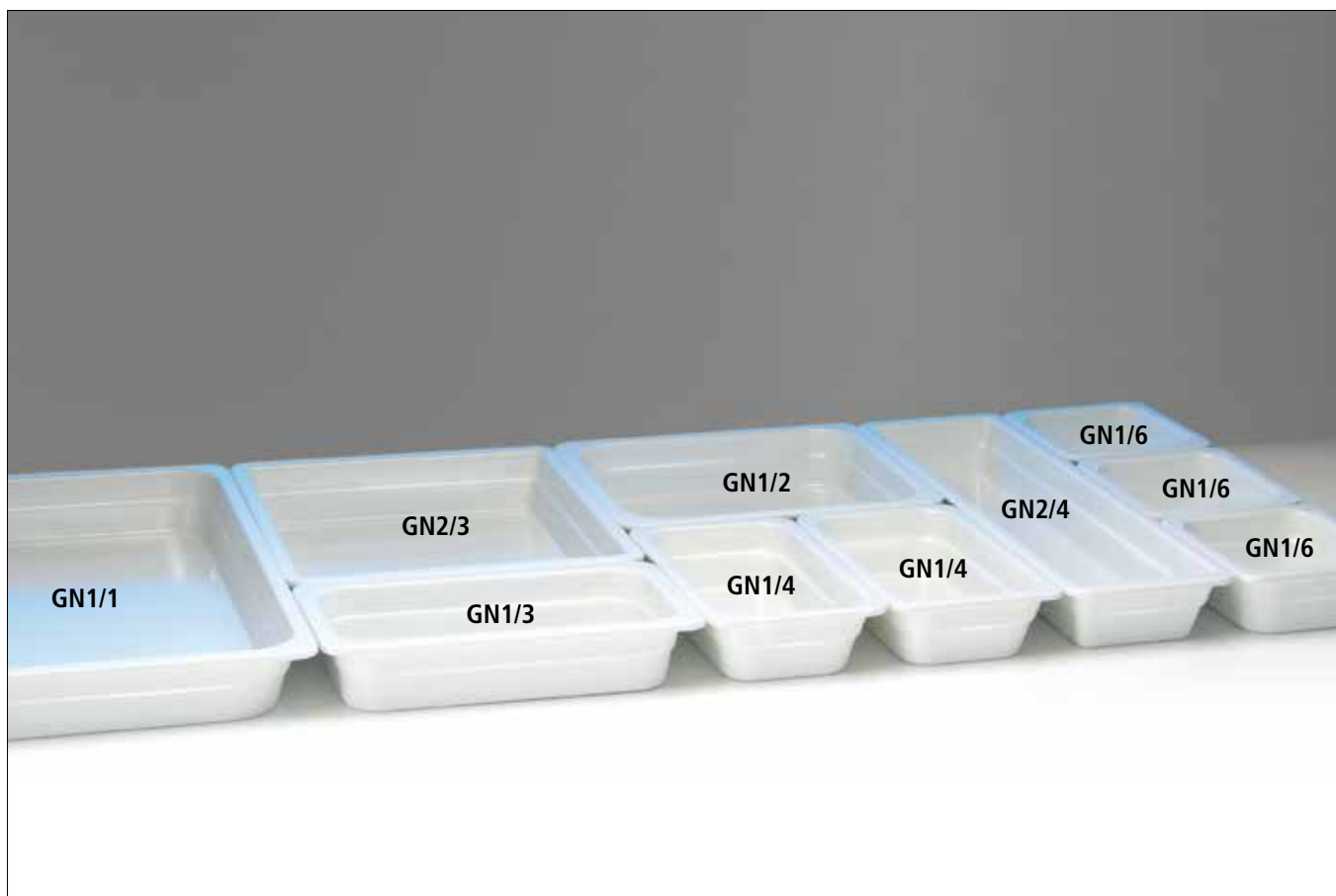

**GN-Behälter „HIGHLINE“**  
**GN-container**  
**cubetas GN**  
**bac GN**



extrem bruchsicher, glänzende und harte Oberfläche, tiefkühlfest, keinen Temperaturschocks unterziehen, nicht auf heißen Flächen liegen lassen

durable, top quality, hard and glossy surface, avoid thermal shocks, do not leave on hot surfaces

duradera, alta calidad, superficie brillante y resistente, hay que evitar los cambios térmicos bruscos, no apoyar en superficies calientes

durable, haute qualité, surface brillante et résistante, éviter les chocs thermiques et ne pas poser sur une surface chaude



83762



83763

	GN	↓ mm	ltr.	☐ cm	€
83772 0	1/1	65	7,10	53,0 x 32,5	36,00
83770 6	2/3	65	4,60	35,0 x 32,5	32,50
83768 3	1/2	65	3,40	32,5 x 26,5	20,00
83766 9	2/4	65	3,00	53,0 x 16,2	23,50
83764 5	1/3	65	2,00	32,5 x 17,6	15,50
83762 1	1/4	65	1,35	26,5 x 16,2	14,50
83760 7	1/6	65	0,80	17,6 x 16,2	11,00
83773 7	1/1	100	11,0	53,0 x 32,5	41,00
83769 0	1/2	100	5,50	32,5 x 26,5	23,40
83765 2	1/3	100	3,15	32,5 x 17,6	18,00
83763 8	1/4	100	2,20	26,5 x 16,2	16,00
83761 4	1/6	100	1,25	17,6 x 16,2	12,40



GN1/1 - Maß

**Besteckbehälter GN1/1  
dispenser GN1/1  
dispensador de cubiertos GN1/1  
bac à couverts GN1/1**



in Handarbeit geflochten, 4 Mulden, Kunststoff-Geflecht, Drahtgestell, braun-schwarz  
wickerwork, 4 compartments, with reinforced chromed wire structure, brown-black  
cesta trensada a mano, 4 compartimentos, de plástico, con bastidor cromado reforzado, marrón oscuro  
corbeille tressée à main, 4 compartiments, en plastique, cadre acier chromé renforcé, couleur marron foncé

	cm	cm		€
11966 6	53 x 32,5	9	●	33,00



GN1/1 - Maß

**Besteckbehälter „BUFFET“ GN1/1  
cutlery dispenser GN1/1  
dispensador de cubiertos GN1/1  
bac à couverts GN1/1**



4 Mulden, Kunststoff-Geflecht, Drahtgestell, beige  
4 troughs, wickerwork, wire, beige  
4 huecos, trabajo de cestería  
4 compartiments, plastique tressé, cadre acier chromé renforcé, couleur osier naturel

	cm	cm		€
11965 9	53 x 32,5	10	●	24,00



11955

11957

**Besteckbehälter GN1/1  
cutlery tray / box stand GN1/1  
dispensador de cubiertos GN1/1  
bac à couverts GN1/1**



	cm	cm		€
11955 0	53 x 32,5	10	●	6,00
11957 4	53 x 32,5	10	○	6,00

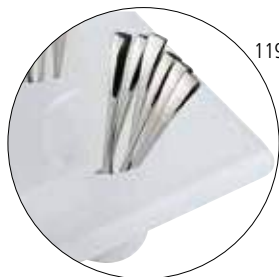

11962



11960

**Besteckkasten GN1/1  
cutlery box GN1/1  
dispensador de cubiertos GN1/1  
bac à couverts GN1/1**



	cm	cm		€
11960 4	53 x 32,5	10	●	6,60
11962 8	53 x 32,5	10	○	6,60



**Tisch Set „VARIO II“**  
table set  
set de mesa  
set de table



4-teilig: 1 Ständer + 3 Behälter (innen Ø 9 cm) für Besteck, Servietten etc., vielseitig einsetzbar  
4 pcs. set: 1 stand + 3 bins (inner Ø 9 cm) for cutlery, napkins etc., versatile applicable  
4 piezas: 1 soporte + 3 recipientes Ø 9 cm para cubiertos, servilletas etc.  
4 pièces: 1 support, 3 récipients Ø 9 cm, pour couverts, serviettes,...

	□ cm	↑ cm	€
11927 7	22 x 22	26	64,00

designed by **CULTURE FORM**

designed by **CULTURE FORM**



**Besteckbehälter**  
cutlery basket  
dispensador de cubiertos  
présentoir à couverts



4 Löcher inkl. 4 Edelstahl Köcher  
4 holes incl. 4 stainless baskets  
4 agujeros, incl. 4 cestas de acero  
4 places, avec 4 corbeille inox

	□ cm	↑ cm	€
93321 7	27 x 27	15	69,00



11994  
mit Köcher /  
included dispenser

11996  
ohne Köcher /  
without dispenser

**Besteckbehälter**  
cutlery basket  
dispensador de cubiertos  
présentoir à couverts



matt poliert  
satin polished finish  
inox mate (sin cubiertos)  
inox mat

	□ cm	↑ cm	€
11994 9	26,0 x 30 Ø 10	20	62,00
			4 Löcher inkl. Köcher (Kunststoff) 4 holes incl. dispensers (plastic) 4 agujeros incl. dispensador plástico 4 places, avec 4 récipients (plastique)
11996 3	26,0 x 30 Ø 10	20	56,00
			4 Löcher ohne Köcher 4 holes without dispensers 4 agujeros sin dispensador de plástico 4 places, sans récipients
11997 0	37,5 x 30 Ø 10	20	77,00
			6 Löcher ohne Köcher 6 holes without dispensers 6 agujeros sin dispensador de plástico 6 places, sans récipients

11997  
ohne Köcher



11998  
Köcher weiß



11999  
Köcher  
Edelstahl

**Besteckköcher**  
cutlery basket  
cesta para cubiertos  
corbeille à couverts



	□ cm	↑ cm	€
11998 7	Ø 9,7	13,7	2,50
			Kunststoff weiß / white plastic plástico blanco / plastique blanc
11999 4	Ø 9,7	13,7	7,90
			matt poliert / satin polished finish acero inoxidable / inox

**NEW**



**Besteckköcher**  
cutlery basket  
cesta para cubiertos  
corbeille à couverts



	□ cm	↑ cm		€
84535 0	12 x 12	16	○	4,90
84536 7	12 x 12	16	●	4,90



**Besteckständer**  
cutlery basket  
cesta para cubiertos  
égouttoir à couverts



matt poliert / satin polished finish / inox mate (sin cubiertos) / inox mat

	□ cm	↑ cm		€
11923 9	Ø 12,5	15,5		9,90



**Besteckständer**  
cutlery basket  
cesta para cubiertos  
égouttoir à couverts



matt poliert / satin polished finish / inox mate (sin cubiertos) / inox mat

	□ cm	↑ cm		€
11921 5	Ø 10	10,0		7,40
11922 2	Ø 12	13,5		9,90



**Besteck-Korb „ECONOMIC“**  
cutlery dispenser  
dispensador de cubiertos  
corbeille à couverts



in Handarbeit geflochten  
wickerwork  
trensado a mano  
tressage à main

	□ cm	↑ cm		€
40130 3	Ø 12	15,0	●	3,00
40131 0	27 x 10	4,5	●	3,00
40007 8	Ø 12	15,0	●	3,00
40009 2	27 x 10	4,5	●	3,00

designed by **ElbeEichhorn**

**NEW**



**Schale "MULTI"  
bowl  
cuenco  
bol**

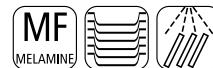

inklusive 3 herausnehmbare Trennwände, 4 Kammern  
including 3 removable divider, 4 chambers  
con 3 divisores extraíbles, 4 compartimentos  
avec 3 parois de séparation amovibles, 4 compartiments

	cm	↑ cm	ltr.		€
84531 2	31,5 x 17,5	7	2,1	○ white	19,00
84532 9	31,5 x 17,5	7	2,1	● anthrazit	19,00

**Eier-Box  
eggs-box  
caja para huevos  
boîte à oeufs**

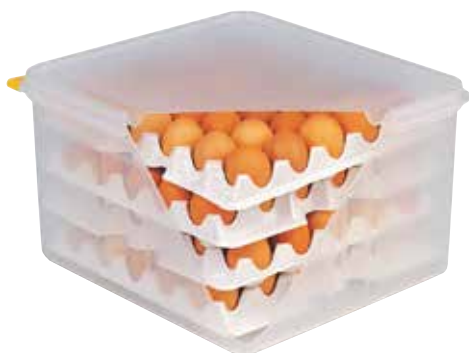

mit luftdichtem Deckel, für 4 Lagen à 30 Eier, Lieferung inkl. 8 Lagen, Größe Lage: 28 x 28 cm  
with airtight cover, capacity: 4 trays of 30 eggs, delivery with 8 trays, size of tray: 28 x 28 cm  
capacidad para 4 bandejas de 30 huevos, tapa hermética, se entrega con 8 bandejas, formato bandejas 28 x 28 cm, apto para lavavajillas  
pour 4 plateaux de 30 oeufs chacun, apte pour 4 plateaux plats, couvercle hermétique, livré avec 8 plateaux, dimension plateau 28x28 cm, lavable en lave-vaisselle

	cm	↓ cm	GN	€
82419 5	35,4 x 32,5	20	2/3	36,00

**Einzelteile / spare parts / piezas sueltas / pièces détachées**

10 Lagen / 10 trays / 10 bandejas / 10 plateaux

82420 1				18,90
---------	--	--	--	-------

**3 Größen / 3 sizes**



**Rechteckschalen  
container  
cubeta  
bac**



	cm	↑ cm	ltr.	€
11941 3	30 x 21,0	6,5	2	4,00
11942 0	34 x 23,5	7,0	3	5,20
11943 7	48 x 33,0	8,0	8	11,00

**Wanne  
container  
cubeta  
bac**



	cm	↑ cm	ltr.	€
11940 6	61 x 44	15	25	21,60

**Geschirrwanne  
container  
cubeta para vajilla  
bac à vaisselle**

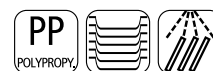

	cm	↑ cm	€
11950 5	55 x 42	14	10,00



# THERMO-BOX



Thermo-Box - Komplett-Lösung für Gastronomie, Catering und Partyservice

mit Extra-Beschriftungsfeld

## System-Thermo-Box GN1/1



beste Isoliereigenschaften, hygienisch, empfohlen nach HACCP, einsetzbar von -40° bis +120°C, mit Beschriftungsfeld, jede Box ist als Deckel- und Bodenteil verwendbar

best isolation quality, hygienic, HACCP standards, usable from -40°C to +120°C, stackable, each box can be used as a lid for the lower box

apilable, aislante, irrompible, higiénico, HACCP stantard de -40° hasta + 120°C, al apilar se puede usar otra caja arriba como tapa, y así sucesivamente

excellente isolation, hygiénique, recommandé HACCP, utilisable entre -40°C et +120°C, empilables une boîte sur l'autre, la boîte supérieur sert alors de couvercle

	□ cm	↑ cm		€
11312 1	59,5 x 39	12,0	Nutzhöhe 8 cm (ohne Deckel)	36,00
11315 2	59,5 x 39	16,5	Nutzhöhe 12 cm (ohne Deckel)	37,00
11319 0	59,5 x 39		Zusatzdeckel, flach	16,00

## Thermo-Box mit Doppelfunktion jede Box ist als Deckel- und Bodenteil verwendbar

## Einzelteile / spare parts / piezas sueltas / pièces détachées

passende Systemtablets  
matching system-trays  
bandeja con sistema  
plateau avec système

11300 8	53 x 32,5	1/1	39,50
11290 2	53 x 32,5	1/1	33,00
83980 9	53,0 x 32,5	1/1	47,00



11300  
passendes Tablett



11290  
passendes Tablett



83980  
passendes Tablett

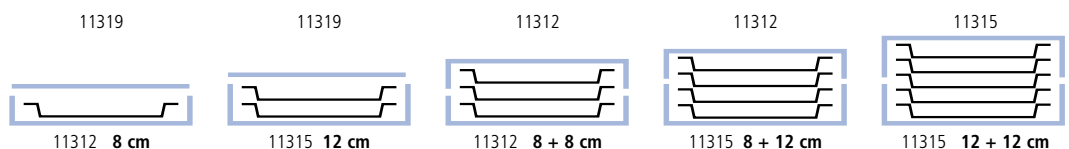

So ergeben sich je nach Bedarf 5 verschiedene Nutzhöhen und Bestückungsmöglichkeiten.



### Thermo-Box „UNIVERSAL“



beste Isoliereigenschaften, hygienisch, empfohlen nach HACCP, einsetzbar von -40°C bis +120°C, mit Beschriftungsfeld, jede Box ist als Deckel- und Bodenteil verwendbar  
best isolation quality, hygienic, HACCP standards, usable from -40°C to +120°C, stackable, each box can be used as a lid for the lower box

	cm	↑ cm	ltr.	€
49258 5	68,5 x 48,5	36	80	84,00

### Thermo-Box „HOT COOL“



beste Isoliereigenschaften, hygienisch, empfohlen nach HACCP, einsetzbar von -40°C bis +120°C, mit Beschriftungsfeld, jede Box ist als Deckel- und Bodenteil verwendbar  
best isolation quality, hygienic, HACCP standards, usable from -40°C to +120°C, stackable, each box can be used as a lid for the lower box

	cm	↑ cm	ltr.	€
49310 0	38,0 x 30,0	13	7,5	21,60

### Thermo-Box „PIZZA“



beste Isoliereigenschaften, hygienisch, empfohlen nach HACCP, einsetzbar von -40°C bis +120°C, mit Beschriftungsfeld, jede Box ist als Deckel- und Bodenteil verwendbar  
best isolation quality, hygienic, HACCP standards, usable from -40°C to +120°C, stackable, each box can be used as a lid for the lower box

	cm	↑ cm	ltr.	€
49738 2	41,0 x 41,0	37,5	37,5	59,00

### Thermo-Box „GN 1/1“



beste Isoliereigenschaften, hygienisch, empfohlen nach HACCP, einsetzbar von -40°C bis +120°C, mit Beschriftungsfeld, jede Box ist als Deckel- und Bodenteil verwendbar  
best isolation quality, hygienic, HACCP standards, usable from -40°C to +120°C, stackable, each box can be used as a lid for the lower box

	cm	↑ cm	ltr.	€
49638 5	59,5 x 39	28	38	59,00



**Servierwagen- / Transportwagen**  
**servicing trolley**  
**carro de servicio**  
**chariot de service**



Lieferung demontiert

Gestell aus Vierkantrrohr 25 x 25 mm, Ablagefläche innen 84 x 44,5 cm, Bodenfläche 90 x 50 cm, auf Unterseite schalldämmend beschichtet, Abstand zwischen den Böden 28 cm/29 cm, mit 4 Lenkrollen Ø 12,5 cm, alle mit Feststellern, Lieferung demontiert, einfache Montage, Tragfähigkeit 33 kg je Boden

frame rectangular bar 25 x 25 mm, shelf board inside 84 x 44,5 cm, shelf board outside 90 x 50 cm, undersurface coated sound-damping, distance between the boards 28 cm/29 cm, with 4 swivel wheels Ø 12,5 cm, all with brakes, unassembled, simple assembly, max load 33 kg per shelf

estructura tubo cuadrado 25 x 25 mm, útiles int. por piso 84 x 44,5 cm. ext. al suelo 90 x 50 cm revestimiento para absorber ruidos distancia entre pisos 28 cm/29 cm, 4 ruedas giratorias 12,50 cm, con frenos, se sirve desmontado, montaje fácil, carga máx. 33 kg por piso

structure en tube carré 25x25 mm, 3 niveaux dimensions utiles 84x44,5 cm, encombrement au sol 90x50 cm, avec revêtement en partie inférieure pour absorber le bruit, distance entre niveaux 28 cm/29 cm, roues pivotantes 12,5 cm, avec frein, livré démonté, montage aisé, max. 33 kg de charge par niveau

	□ cm	↑ cm	€
71440 3	96 x 50	94	172,00



**Servier- / Transportwagen**  
**service trolley**  
**carro de servicio**  
**chariot de service**



Lieferung demontiert

mit 3 Borden, Bordmaße ca. 83 x 51 cm, Abstand zwischen den Borden ca. 26 cm, Tragfähigkeit 120 kg, 4 Lenkrollen, davon 2 feststellbar, Lieferung demontiert, einfache Montage

with 3 trays, trays approx. 83 x 51 cm, size between the trays approx. 26 cm, total load capacity 120 kg, 4 wheels with 2 brakes, unassembled, simple assembly

con 3 bandejas inox mate, aprox. 83 x 51 cm, la medida entre bandejas aprox. 26 cm capacidad total 120 kg, 4 ruedas con 2 frenos, construcción robusta, montaje fácil

3 niveaux, approx. 83x51 cm chacun, distance entre niveaux 26 cm, capacité maxi 120 kg au total, 4 roues dont 2 avec frein, construction robuste, montage facile

	□ cm	↑ cm	€
11979 6	91 x 59	93	156,00



**Servier- / Transportwagen**  
**service trolley**  
**carro de servicio**  
**chariot de service**



Lieferung demontiert

mit 2 Borden, Bordmaße ca. 83 x 51 cm, Abstand zwischen den Borden ca. 56 cm, Tragfähigkeit 80 kg, 4 Lenkrollen, davon 2 feststellbar, Lieferung demontiert, einfache Montage

with 2 trays, trays approx. 83 x 51 cm, size between the trays approx. 56 cm, total load capacity 80 kg, 4 wheels with 2 brakes, unassembled, simple assembly

con 2 bandejas de acero inoxidable mate, aprox. 83 x 51 cm, la medida entre bandejas aprox. 56 cm, capacidad total 80 kg, 4 ruedas, con 2 frenos, construcción robusta, montaje fácil

2 niveaux, approx. 83x51 cm chacun, distance entre niveaux 56 cm, capacité maxi 80 kg au total, 4 roues dont 2 avec frein, construction robuste, montage facile

	□ cm	↑ cm	€
11977 2	91 x 59	93	134,00



Lieferung demontiert

**Regalwagen GN1/1**  
**trolley GN1/1**  
**carro GN1/1**  
**chariot GN1/1**



mit 15 Doppelauflegeschielen, zum Transport von bis zu 30 GN-Tablets GN1/2 oder 15 GN-Behältern bis GN1/1 (Längseinschub), bei einem Stapelabstand von 75 mm, mit 4 Lenkrollen, 2 mit Feststellern, Tragfähigkeit 100 kg

15 double bars, for transporting up to 30 trays GN1/2 or 15 GN-containers up to GN1/1, size between the trays 75 mm, 4 swivel wheels, 2 equipped with brakes total load capacity 100 kg

15 pares de rieles dobles para el transporte de hasta 30 bandejas o 15 cubetas GN1/1 (apertura por el lado estrecho) distancia entre las bandejas de 75 mm, 2 ruedas giratorias con frenos, carga máxima 100 kg

15 rails doubles pour maxi 30 plateaux GN1/2 ou 15 plateaux GN1/1 (ouverture sur le côté étroit 32,5cm), espace entre plateaux 75 mm, 2 roues pivotantes avec frein, charge maxi 100 kg

	☐ cm	↑ cm	€
71441 0	55 x 38,5	173,5	254,00



mit beidseitiger Kipp- und Durchschubsicherung

**HOT PRICE**



4 Lenkrollen  
 inklusive Feststellern  
 Lieferung demontiert

**Servier- / Transportwagen**  
**servicing trolley**  
**carro de servicio**  
**chariot de service**



Aluminiumrahmen, 3 Böden, Abstand zwischen den Böden 31 cm, mit 4 Lenkrollen, alle mit Feststellern, Tragfähigkeit: ca. 150 kg je Boden, 450 kg insgesamt, demontiert, einfache Montage, Lieferung ohne Container und Dekoration

frame aluminium, 3 shelves, distance between shelves 31 cm, 4 swivel wheels, all equipped with brakes, max. load per shelf 150 kg, 450 kg total, demounted, easy to mount, delivery without containers and decoration

marco aluminio, 3 pisos, distancia entre cada piso 31 cm, 4 ruedas giratorias, las 4 con frenos, carga máxima por bandeja 150 kg, 450 kg en total, se sirve desmontado, fácil de montar (se entrega sin contenedores ni decoración)

chassis aluminium, 3 étages, distance entre niveaux 31 cm, 4 roues pivotantes, toutes avec frein, charge maximum 150 kg par niveau, 450 kg au total, livré démonté, montage facile (livré sans récipients ni décoration)

	☐ cm	↑ cm	€
11945 1	108 x 50	96	114,00



11947



11946

**Container**  
**container**  
**contenedor**  
**réceptient**



zum Einhängen, passend zum Servier- / Transportwagen 11945

to hang up, suitable serving trolley 11945

para colgar, adaptado para el carro ref. 11945

à suspendre, pour chariot de service 11945

	☐ cm	↑ cm	ltr.	€
11947 5	33 x 23	17,5	13	14,00
11946 8	33 x 23	56,5	42	28,00

# STOP-TOOLS designed by formel<sup>23</sup> PRODUKTDESIGN

Die **STOP**-Funktion verhindert, dass Gabel oder Löffel in das Gefäß rutschen.

The smart **STOP**-function prevent forks and spoon not to slip into the vessel.

La función **STOP** evita que los cubiertos se caigan dentro del recipiente. Antideslizante.

La fonction **STOP** empêche les couverts de glisser dans le récipient.



**Fleischgabel**  
**meat fork**  
**tenedor de carne**  
**fourchette à viande**



Materialdicke 2,5 mm, ergonomischer rutschfester Griff  
ergonomic antislip handle  
mango ergonómico antideslizante  
manche ergonomique antidérapante

	cm	→ cm	€
00831 1	10,5	38,5	9,40



**Schöpflöffel**  
**ladle**  
**cucharón**  
**louche**



Materialdicke 2,5 mm, ergonomischer rutschfester Griff  
ergonomic antislip handle  
mango ergonómico antideslizante  
manche ergonomique antidérapante

	cm	→ cm	€
00832 8	Ø 9	35	9,90



**Servierlöffel geschlitzt**  
**slotted spoon**  
**cuchara de servicio**  
**cuillère de service**



Materialdicke 2,5 mm, ergonomischer rutschfester Griff  
ergonomic antislip handle  
mango ergonómico antideslizante  
manche ergonomique antidérapante

	cm	→ cm	€
00833 5	10 x 7,5	37,5	9,60



**Servierlöffel**  
**spoon**  
**cuchara de servicio**  
**cuillère de service**



Materialdicke 2,5 mm, ergonomischer rutschfester Griff  
ergonomic antislip handle  
mango ergonómico antideslizante  
manche ergonomique antidérapante

	cm	→ cm	€
00834 2	10 x 7,5	37,5	9,60



**Schöpflöffel „PROFI“**  
ladle  
cacillo  
louche



	□ cm	→ cm	ltr.	€
00710 9	Ø 5	32,0	0,030	11,40
00711 6	Ø 6	34,0	0,050	12,00
00712 3	Ø 7	35,5	0,080	12,40
00713 0	Ø 8	38,0	0,125	13,50
00714 7	Ø 9	42,0	0,150	15,40
00715 4	Ø 10	43,5	0,250	16,20
00716 1	Ø 11	45,0	0,300	16,80
00717 8	Ø 14,5	48,0	0,550	17,80



**Schaumlöffel „PROFI“**  
skimmer  
espumadera  
écumoire



	□ cm	→ cm	€
00720 8	Ø 8	37,0	11,80
00721 5	Ø 10	40,5	13,00
00722 2	Ø 12	46,0	14,00
00723 9	Ø 14	50,5	15,20



**Wender „PROFI“**  
turner  
espátula  
spatule



	□ cm	→ cm	€
00730 7	10 x 11,5	52	15,20



**Servierlöffel „PROFI“**  
spoon  
cuchara de servicio  
cuillère de service



	□ cm	→ cm	€
00672 0	10,5 x 7	41	9,00



**Servierlöffel geschlitzt „PROFI“**  
slotted spoon  
cuchara de servicio agujereada  
cuillère de service ajourée



	□ cm	→ cm	€
00671 3	10,5 x 7	41	9,00



**Spaghettilöffel „PROFI“**  
spaghetti spoon  
cuchara de espaguetis  
cuillère à spaghettis



	□ cm	→ cm	€
00673 7	11 x 6,5	39	9,80



**Fleischgabel**  
**meat fork**  
**tenedor de carne**  
**fourchette à viande**



	cm	→ cm	€
00666 9	7 / 10	34	6,40



**rutschsichere Griffe, schwarzer Griff, hitzebeständig bis 120°C**  
**antislip, black handle, heat-resistant up to 120°C**  
**antideslizante, mango negro, resistente hasta + 120°C**  
**antiglisse, manche noir, résistant à +120°C**



**Schöpföffel**  
**ladle**  
**cucharón**  
**louche**



	cm	→ cm	ltr.	€
00670 6	9 x 9	34	0,15	7,00



**Servierlöffel**  
**spoon**  
**cuchara**  
**cuillère**



	cm	→ cm	€
00662 1	10,5 x 7	34	6,40



**Servierlöffel gelocht**  
**slotted spoon**  
**cuchara de servicio**  
**cuillère de service**



	cm	→ cm	€
00664 5	10,5 x 7	34	6,40



**Bratenwender**  
**slotted turner**  
**espátula para plancha**  
**spatule pour le grill**



	cm	→ cm	€
00668 3	10 x 8	36	7,00





36087  
glasklar / clear

**Wein- / Sektkühler**  
wine / champagne bowl  
cubitera para vino y cava  
seau à vin ou champagne



mit seitlichen Griffen, transparent  
with lateral handles, transparent  
con asas laterales  
avec poignées latérales

	□ cm	↑ cm	ltr.		€
36087 7	32 x 21,5	24,5	7	○ clear	23,00
36088 4	32 x 21,5	24,5	7	● green	23,00
36089 1	32 x 21,5	24,5	7	● pink	23,00



36088  
grün / green



36089  
pink



36078  
glasklar / clear

**Wein- / Sektkühler**  
wine / champagne bowl  
cubitera para vino y cava  
seau à vin ou champagne



	□ cm	↑ cm	ltr.		€
36078 5	Ø 20	25	3,5	○ clear	17,40
36079 2	Ø 20	25	3,5	● black	17,40
36080 8	Ø 20	25	3,5	○ white	17,40



36079  
schwarz / black



36080  
weiß / white

**HOT  
PRICE**



**Wein- / Sektkühler**  
wine / champagne bowl  
cubitera para vino y cava  
seau à vin ou champagne



glasklarer Rand, transparent gefrostet  
edge transparent, body transparent frosted  
borde transparente, cuerpo transparente efecto glaseado  
bord transparent, corps finition mate

	□ cm	↑ cm	ltr.	€
36066 2	Ø 22 / 14	23	4	8,70





**Flaschenkühler / Getränkeschale**  
**bottle cooler / bowl**  
**enfriador de botella**  
**rafraîchisseur de bouteille**



mit seitlichen Griffen, transparent  
 with lateral handles, transparent  
 con asas laterales  
 avec poignées latérales

	□ cm	↑ cm	ltr.	€
36082 2	35,5 x 35,5	20	16	38,00



**Wein- / Sektkühler**  
**wine / champagne bowl**  
**cubitera para vino y cava**  
**seau à vin ou champagne**



mit seitlichen Griffen, transparent  
 with lateral handles, transparent  
 con asas laterales  
 avec poignées latérales

	□ cm	↑ cm	ltr.	€
36081 5	20 x 20	20	4,5	17,40



**Wein- / Sektkühler**  
**wine / champagne bowl**  
**cubitera para vino y cava**  
**seau à vin ou champagne**



innen mattiert, außen hochglanz, mit massiven Knopf-Griffen, extra stabiler eingerollter Rand, schwere Ausführung  
 outside mirror polished finish, inside satin polished finish, with solid knob handles, rolled edge, heavy quality  
 acabado pulido brillante, asas de botón robustas, borde redondeado, alta calidad  
 brillant, 2 poignées robuste en forme de bouton, bord arrondi, haute qualité

	□ cm	↑ cm	ltr.	€
36028 0	Ø 21,5 / 16	22	4	19,90



**Wein- / Sektkühler „HAMMERSCHLAG“**  
**wine / champagne bowl**  
**cubitera para vino y cava**  
**seau à vin ou champagne**



hochglanzpoliert, mit massiven Ring-Griffen, eingerollter Rand  
 mirror polished finish, with solid ring handles, rolled edge, hammered  
 acabado pulido brillante, con 2 anillos macizos, borde redondeado, repujado  
 brillant, 2 anneaux massifs, bord arrondi, surface martelée

	□ cm	↑ cm	ltr.	€
36026 6	Ø 21 / 17	21,5	4	15,00

NEW



**Mini-Eiseimer / Mini-Sektkühler**  
**ice bucket**  
**cupitera clásica**  
**seau à glaçons classique**



ideal zum Servieren kleiner Mengen Eiswürfel oder zum Aufbewahren im Bar-/Thekenbereich  
ideal for serving small amounts of ice cubes or for storing in the bar/counter area  
ideal para servir pequeñas cantidades de cubitos de hielo o para almacenar en el bar/la barra  
idéal pour servir de petites quantités de cubes de glace ou pour le stockage dans le bar/comptoir

	□ cm	↑ cm	ltr.	€
36003 7	Ø 10,5	10	0,65	8,00
36004 4	Ø 13	13	1,0	10,00



**Wein- / Sektkühler**  
**wine / champagne bowl**  
**cupitera para vino y cava**  
**seau à vin ou champagne**



innen mattiert, außen poliert, mit massiven Griffen, Rand ingerollt  
outside mirror polished finish, inside satin polished finish, with massive handles, rolled edge  
pulido mate, 2 asas macizas, borde redondeado  
finition mate, 2 anses massives, bord rond

	□ cm	↑ cm	ltr.	€
36025 9	Ø 21 / 15	21	3,5	16,00



**Wein- / Sektkühler**  
**wine / champagne bowl**  
**cupitera para vino y cava**  
**seau à vin ou champagne**



matt poliert, Hohlgriffe  
satin polished finish, hollow handles  
acabado pulido satinado, con asas huecas  
finition mate, 2 boutons creux

	□ cm	↑ cm	ltr.	€
36021 1	Ø 20 / 15	20,5	4	13,50

HOT PRICE



**Wein- / Sektkühler**  
**wine / champagne bowl**  
**cupitera para vino y cava**  
**seau à vin ou champagne**



aussen hochglanzpoliert, innen matt poliert, mit Ring-Griffen  
outside mirror polished finish, inside satin polished finish, with ring handles  
exterior pulido brillante, interior efecto satinado con 2 asas anillos  
extérieur brillant, intérieur satin, avec 2 anneaux

	□ cm	↑ cm	ltr.	€
36020 4	Ø 20 / 15	19	3	12,00

designed by **CULTURE FORM**

**Ständer für Wein- / Sektkühler**  
**stand for wine / champagne bowl**  
**pie porta champañera / vino**  
**pied pour seau à champagne / vin**



innen Ø 17,5 cm



Höhe  
73 cm

Ø 26,5 cm

36069

hochglanzpoliert, schwerer standsicherer Fuß, Innendurchmesser der Schale Ø 17,5 cm  
 mirror polished finish, heavy foot, inner bowl Ø 17,5 cm  
 acabado pulido efecto brillante, utilizable para todos los enfriadores de vinos APS, bol interior de Ø 17,5 cm  
 brillant, apte pour tous les seaux à vin ou champagne de APS, intérieur support Ø 17,5 cm

	☐ cm	↑ cm	€
36069 3	Ø 17,5 / 26,5	73	99,00



36028



Ø 15 cm

Höhe  
68 cm

Ø 28 cm

36068

**Ständer für Wein- / Sektkühler**  
**stand for wine / champagne bowl**  
**pie porta champañera / vino**  
**pied pour seau à champagne / vin**



hochglanzpoliert, schwerer standsicherer Fuß, Innendurchmesser der Schale Ø 15 cm  
 mirror polished finish, heavy foot, inner bowl Ø 15 cm  
 acabado pulido efecto brillante, utilizable para todos los enfriadores de vinos APS, bol interior de Ø 15 cm  
 brillant, apte pour tous les seaux à vin ou champagne de APS, intérieur support Ø 15 cm

	☐ cm	↑ cm	€
36068 6	Ø 15 / 28	68	79,00

**Tischhalterung für Sektkühler**  
**Champagne Bucket Table holder**  
**soporte champañera universal**  
**porte-seau à champagne**



Ø 18 cm

aus 8 mm starkem Stahldraht, passend zu allen lieferbaren Sektkühlern, innen Ø-Ring: 18 cm  
 8 mm chrome plated wire, suitable for all available champagne buckets  
 alambre cromado 8 mm, para todas las champañeras  
 fil chromé 8 mm, pour tous les seaux à champagne

	☐ cm	↑ cm	€
30332 4	49 x 20	17	10,50



**Champagnerkühler „CHAMPION“**  
 champagne bowl  
 champañera  
 seau à champagne



doppelwandig für beste Isolierung, hochglanzpoliert  
 double wall cooler keeps the temperature for a long time, mirror polished  
 champañera inox de doble pared, interior mate, exterior brillante  
 seau inox double paroi, maintient le froid plus longtemps, intérieur mat, extérieur poli brillant

	cm	cm	ltr.	€
36076 1	Ø 44	32	15	298,00



**doppelwandig**  
**double wall**

designed by **CULTURE FORM**

**Flaschenkühler „BRIDGE“**  
 bottle cooler  
 champañera de bufé  
 seau à champagne



doppelwandig für beste Isolierung, außen poliert, innen mattiert  
 double wall cooler keeps the temperature for a long time, outside mirror polished, inside matt finish  
 champañera inox de doble pared, interior mate, exterior brillante  
 seau inox double paroi, maintient le froid plus longtemps, intérieur mat, extérieur poli brillant

	cm	cm	ltr.	€
36077 8	Ø 31	19	10	98,00



**10 ltr.**





**Champagnerkühler  
champagne bowl  
cubo champañera  
seau à champagne**



hochglanzpoliert, doppelwandig  
mirror polished finish, double wall  
acabado pulido brillante con doble pared  
brillant, double paroi

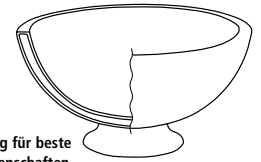

doppelwandig für beste  
Isolationseigenschaften

	□ cm	↑ cm	ltr.	€
36044 0	Ø 44 / 25	24	10,5	99,00



**Champagnerkühler  
champagne bowl  
cubo champañera  
seau à champagne**



außen hochglanzpoliert, innen matt poliert, mit vergoldeten Griffen  
outside mirror polished finish, inside satin polished finish, with gold plated handles  
exterior pulido brillante, interior satinado  
extérieur brillant, intérieur satin

	□ cm	↑ cm	ltr.	€
36047 1	Ø 42 / 27	28	20	79,00



**Champagnerkühler  
champagne bowl  
cubo champañera  
seau à champagne**



hochglanzpoliert, Lieferung ohne Gläser-Ring  
mirror polished finish, delivery without holder  
acabado efecto brillante, se entrega sin el aro colgador para copas  
brillant, livré sans le support à flûtes

	□ cm	↑ cm	ltr.	€
36045 7	Ø 40,5 / 27,5	22,5	13,5	49,90

**Gläser-Ring  
ring / holder  
aro colgador para copas  
cerce support à flûtes**



12 Gläser einhängbar / usable for 12 glasses / para 12 copas / pour 12 verres

	□ cm	↑ cm	€
36065 5	Ø 48,5	4	21,00



**Champagnerkühler  
champagne bowl  
cubo champañera  
seau à champagne**



hochglanzpoliert, Rand matt poliert  
mirror polished finish, edge satin polished finish  
acabado pulido brillante, borde satinado  
brillant, bord mat

	□ cm	↑ cm	ltr.	€
36046 4	Ø 45 / 21	23	12	39,90



**Champagnerkühler  
champagne bowl  
champañera  
seau à champagne**



glasklar  
transparent  
transparente  
transparent

	□ cm	↑ cm	ltr.	€
36049 5	Ø 44 / 26	25	15	77,00



**Wein- / Sektkühler  
wine / champagne bowl  
cubitera para vino y cava  
seau à vin ou champagne**



glasklar, für bis zu 6 Flaschen geeignet  
transparent, suitable for up to 6 bottles  
transparente para máximo de 6 botellas  
transparent, maxi 6 bouteilles

	□ cm	↑ cm	ltr.	€
36057 0	47 x 28	23	10	36,00



**Wein- / Sektkühler  
wine / champagne bowl  
cubitera para vino y cava  
seau à vin ou champagne**



glasklar, für zwei Flaschen  
transparent, for two bottles  
transparente, para 2 botellas  
transparent, pour 2 bouteilles

	□ cm	↑ cm	ltr.	€
36056 3	30,5 x 21,5	26	4	19,50



**Wein- / Sektkühler  
wine / champagne bowl  
cubitera para vino y cava  
seau à vin ou champagne**



glasklar, mit Tragegriff  
transparent, handle on the side  
transparente, con un asa en el lateral  
transparent, avec poignée

	□ cm	↑ cm	ltr.	€
36055 6	23 x 22	27,5	3	17,00



36071



36072



36073

**Wein- / Sektkühler**  
**wine / champagne bowl**  
**cupitera para vino y cava**  
**seau à vin ou champagne**



	☐ cm	↑ cm	ltr.		€
36071 6	30,5 x 22,5	23,5	5	○ klar / clear	19,00
36072 3	30,5 x 22,5	23,5	5	●	19,00
36073 0	30,5 x 22,5	23,5	5	●	19,00



36048



36053

**Wein- / Sektkühler**  
**wine / champagne bowl**  
**cupitera para vino y cava**  
**seau à vin ou champagne**



mit 2 seitlichen Eingriffen  
 with 2 handles on the side  
 con 2 asas  
 avec 2 poignées

	☐ cm	↑ cm	ltr.		€
36048 8	35 x 27	25,5	6	○ klar / clear	28,00
36052 5	27 x 20	21	3	○ klar / clear	16,00
36054 9	35 x 27	25,5	6	●	30,00
36053 2	27 x 20	21	3	●	18,00



designed by **sieger design**

**Konferenzkühler „SIEGER DESIGN“**  
**conference bottle cooler**  
**enfriador múltiple**  
**rafraîchisseur CONFÉRENCE**



inkl. Kühlakku, Flaschenöffner, Kronkorkenschale, mit 6 Öffnungen Ø 6,7 cm für 0,25 - 0,5 Liter-Flaschen

incl. bottle cooler, bottle opener, small cap bowl, with 6 holes Ø 6,7 cm for 0,25 to 0,5 liter bottles

con acumulador de frío, abridor, recuperador de chapas, 6 plazas Ø 6,7 cm, para botellas de 25 a 50 cl

avec accumulateur de froid, décapsuleur, bol récupérateur de capsules, 6 places Ø 6,7 cm, pour bouteilles de 25 à 50 cl



00620

	☐ cm	↑ cm		€
00620 1	Ø 23	14	○	46,00
00621 8	Ø 23	14	●	46,00

**Einzelteile / spare parts / piezas sueltas / pièces détachées**

Kühlakku / cooler / acumulador de frío / accumulateur de froid				€
00616 4	Ø 7,5	11,5	○	10,00
00615 7	Ø 7,5	11,5	●	10,00

Flaschenöffner / bottle opener / abridor / décapsuleur				€
00617 1	Ø 1	13,5		5,10

Kronkorkenschale / cap bowl / cuenco para chapas / bol récupérateur de capsules				€
00618 8	Ø 6,5	3	○	2,10
00619 5	Ø 6,5	3	●	2,10



00621



00617  
Flaschenöffner



stapelbar



00616  
Kühlakku



NEW



**Flaschenkühler „ELEMENT“**  
bottle cooler  
enfriador de botella  
rafraîchisseur de bouteille



Beton, mit möbelschonender Unterseite  
concrete, with non-scratching undersurface  
el hornigón, con base antirraladuras  
le béton, avec base revêtue antirayures

	☐ cm	↑ cm	€
36090 7	Ø 12 / 10	19	16,00

**hervorragende Kühlung**  
keeps temperature for a long time

designed by **sieger design**

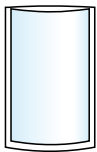

doppelwandig  
double wall

**Flaschenkühler „CRYSTAL“**  
bottle cooler  
enfriador de botella  
rafraîchisseur de bouteille



doppelwandig für beste Isolierung, glasklar  
doublewall, clear  
doble pared  
double paroi

	☐ cm	↑ cm	€
36062 4	Ø 13,5 / 10,5	23	7,90

designed by **sieger design**

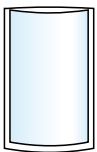

doppelwandig  
double wall

**Flaschenkühler „PURE“**  
bottle cooler  
enfriador de botella  
rafraîchisseur de bouteille



doppelwandig für beste Isolierung, glasklar  
doublewall, clear  
doble pared  
double paroi

	☐ cm	↑ cm	€
36063 1	Ø 13,5 / 10,5	23	7,90

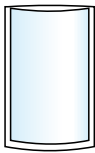

doppelwandig  
double wall

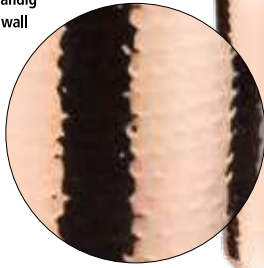

**Flaschenkühler „CUPPER“**  
bottle cooler  
enfriador de botella  
rafraîchisseur de bouteille



Hammerschlagoptik, doppelwandig für beste Isolierung  
double wall cooler keeps the temperature for a long time, hammered look  
doble pared para mantener el frío largo tiempo  
double paroi pour une meilleure conservation de la température

	□ cm	↑ cm		€
36074 7	Ø 12	20	● copper	23,00

**Edelstahl, außen verkupfert  
und anlaufgeschützt**

designed by **CULTURE FORM**

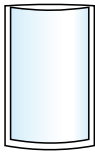

doppelwandig  
double wall

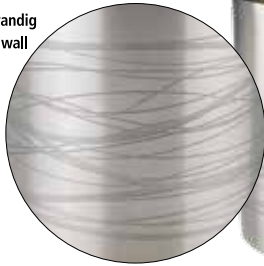

**Flaschenkühler „LINES“**  
bottle cooler  
enfriador de botella  
rafraîchisseur de bouteille



matt poliert, doppelwandig für beste Isolierung, für 0,7 - 1,5 Liter-Flaschen  
satin polished finish, double wall cooler keeps the temperature for a long time, for 0,7 - 1,5 ltr. bottles  
acero inoxidable mate con doble pared para mantener el frío largo tiempo, botellas de 0,7 - 1,5 ltr.  
inox mat, double paroi pour une meilleure conservation de la température, pour bouteilles de 0,7 à 1,5 l.

	□ cm	↑ cm		€
36002 0	Ø 12	20		20,00

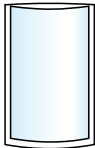

doppelwandig  
double wall



**Flaschenkühler**  
bottle cooler  
enfriador de botella  
rafraîchisseur de bouteille



matt poliert, doppelwandig für beste Isolierung, für 0,7 - 1,5 Liter-Flaschen  
satin polished finish, double wall cooler keeps the temperature for a long time, for 0,7 - 1,5 ltr. bottles  
acero inoxidable mate con doble pared para mantener el frío largo tiempo, botellas de 0,7 - 1,5 ltr.  
inox mat, double paroi pour une meilleure conservation de la température, pour bouteilles de 0,7 à 1,5 l.

	□ cm	↑ cm		€
36030 3	Ø 12 / 10	20		19,00

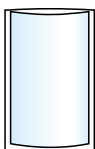

doppelwandig  
double wall



**Flaschenkühler**  
bottle cooler  
enfriador de botella  
rafraîchisseur de bouteille



matt poliert, taillierte Form, doppelwandig für beste Isolierung, für 0,5 - 1,5 Liter-Flaschen  
satin polished finish, waisted form, double wall, for 0,5 - 1,5 ltr. bottles  
acabado pulido mate, diseño „entallado“, con doble pared para botellas de 0,5 a 1,5 ltr.  
inox mat, forme design, double paroi pour une meilleure conservation de la température, pour bouteilles de 0,5 à 1,5 l.

	□ cm	↑ cm		€
36038 9	Ø 12,5 / 10	19		21,00



**Flaschenkühler „CLASSIC“**  
**bottle cooler**  
**enfriador de botella**  
**rafraîchisseur de bouteille**



edler Kunststoffmantel in matt-metall Optik, Rand hochglanzpoliert, speziell isolierter Kunststoffeinsatz sorgt für beste Kühlung, für 0,5 - 1,5 Liter-Flaschen, Material: Mylar  
 noble plastic jacket in satin metal look, mirror polished finish edge, special insulated plastic insert, for 0,5 - 1,5 ltr. bottles

plástico imitación metal aspecto satinado, borde brillante, aislado interior especial para botellas de 0,5 a 1,5 ltr.

plastique aspect métal satiné, bord brillant, paroi intérieure spécialement isolante pour bouteilles de 0,5 à 1,5 l.

	☐ cm	↑ cm	€
36036 5	Ø 12,5	22	14,20

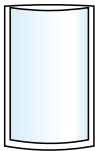

doppelwandig  
double wall



**Flaschenkühler**  
**bottle cooler**  
**enfriador de botella**  
**rafraîchisseur de bouteille**

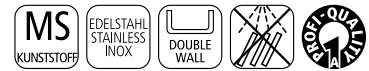

Rand matt poliert, doppelwandig für beste Isolierung, für 0,7 - 1,5 Liter Flaschen, Größe außen Ø 11,5 cm, Größe innen Ø 9,5 cm

satin polished finish edge, double wall cooler keeps the temperature for a long time, for 0,7 - 1,5 ltr. bottles, size outside Ø 11,5 cm, size inside Ø 9,5 cm

borde pulido satinado, con doble pared para mantener más tiempo la temperatura para botellas de 0,7 a 1,5 l., medida exterior 11,5 cm, medida interior 9,5 cm

bord métallique mat, double paroi pour excellente conservation de la température, pour bouteilles de 0,7 à 1,5 l. Ø ext. 11,5cm, Ø int. 9,5 cm

	☐ cm	↑ cm	€
36050 1	Ø 11,5 / 9,5	23	18,90

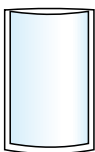

doppelwandig  
double wall



**Flaschenkühler „ICE“**  
**bottle cooler**  
**enfriador de botella**  
**rafraîchisseur de bouteille**

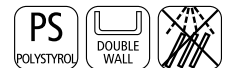

transparent gefrostet, doppelwandig für beste Isolierung, ergonomische Rundung für eine bessere Handhabung, für 0,7 - 1,5 Liter Flaschen, Design patentiert, Größe außen Ø 14 cm, Größe innen Ø 10 cm

transparent frosted, double wall cooler keeps the temperature for a long time, ergonomic rounded for a better handling, for 0,7 - 1,5 ltr. bottles, design patented, size outside Ø 14 cm, size inside Ø 10 cm

transparente glaseado, la doble pared mantiene la temperatura durante mucho tiempo, diseño redondeado ergonómico para una mejor sujeción, plástico transparente satinado, para botellas de 0,7 - 1,5 diseño patentado, exterior Ø 14 cm, interior 10 cm

transparent satiné, design breveté ergonomique pour facile préhension, double paroi pour excellente conservation de la température, pour bouteilles de 0,7 à 1,5 l. Ø ext. 14 cm, Ø int. 10 cm

	☐ cm	↑ cm	€
36042 6	Ø 14 / 10	23,5	10,50

**HOT  
PRICE**

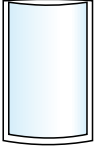

doppelwandig  
double wall



36032



36034

**Flaschenkühler  
bottle cooler  
enfriador de botella  
rafraîchisseur de bouteille**



transparent, doppelwandig für beste Isolierung, mit Chromrand, Größe außen Ø 12 cm, Größe innen Ø 10 cm

transparent, double wall cooler keeps the temperature for a long time, with chrome edge, size outside Ø 12 cm, size inside Ø 10 cm

transparente, doble pared mantiene la temperaruta por largo tiempo, borde superior cromado, medida exterior Ø 12 cm, interior Ø 10 cm

transparent, bord chromé brillant, double paroi pour maintien en température, Ø ext. 12 cm, Ø int. 10 cm

	cm	cm			€
36032 7	Ø 12 / 10	23	○	transparent	6,90
36034 1	Ø 12 / 10	23	●	blau-transparent	6,90



platin

schwarz  
black

36083

36084

**Kühlmanschette „WINE“  
cool collar  
funda enfriadora  
manchette rafraîchissante**



Aktivkühler, ohne Eis, nach 5 Minuten gekühlt, Aufbewahrung im Gefrierfach

active chiller without ice, chilled in 5 minutes, keep in the freezer

enfria sin hielo, en sólo 5 minutos, guardar en el congelador

refroidit en 5 minutes, sans glace, conserver au congélateur

	cm	cm			€
36083 9	14 x 2	17,5	●		8,40
36084 6	14 x 2	17,5	●		8,40

für Mineralwasser- und Weinflaschen  
for soda- or winebottles



**Kühlmanschette  
cool collar  
funda de frío  
housse isotherme**



für Sekt- / Champagnerflaschen, einfach im Gefrierfach einfrieren, komplette Flasche wird in 5 Min. auf angenehme Trinktemperatur gekühlt, außen reißfestes Stoffgewebe, innen Kunststoff mit Kühlgel gefüllt, unbegrenzt wiederverwendbar

for bottles of champagne, simply to freeze in the freezer, complete bottles will be cooled down in only 5 minutes, tearproof cloth outside, plastic filled with gel inside, unlimited reusable

para botellas de cava o champán simplemente congelándola en el congelador, la botella entera se enfriará en 5 minutos, funda de plástico muy robusta, rellena con un gel congelante reutilizable ilimitadamente

pour bouteilles de vin ou champagne, la housse est préalablement stockée au congélateur, où elle accumule le froid, ensuite elle refroidit une bouteille en quelques minutes, plastique résistant, contient un liquide congelant, à réutiliser de façon illimitée

	cm	cm			€
36075 4	Ø 11	18			6,00

für Sekt- und Champagnerflaschen  
for champagnebottles



93311  
Ø 9 cm  
gehämmerte  
Oberfläche

93310  
Ø 9 cm

**NEW**

stainless  
steel  
handle



93310

**Becher „MOSCOW MULE“  
barrel copper mug  
taza  
gobelet**



Edelstahlbecher, Kupferlook  
stainless steel cup, copper look  
taza de acero, por fuera encobrada  
gobelet en acier, de l'extérieur cuivré

	□ cm	↑ cm	ltr.		€
93310 1	Ø 9	9,0	0,5	●	16,00
93311 8	Ø 9	9,5	0,55	●	14,00

gehämmerte Oberfläche  
hammered



93311

gold  
plated  
handle



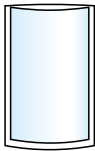

doppelwandig  
double wall



mit Eiszange

**Eiseimer-Set mit Eiszange**  
**ice bucket set with tong**  
**cubitera isotérmica**  
**seau à glaçons isothermique**



Deckel hochglanzpoliert, Behälter matt poliert, inkl. Edelstahl-Eiszange  
cover mirror polished finish, container satin polished finish, incl. stainless steel tong  
tapa pulida efecto brillante, con doble pared, con pinza de hielo  
couvercle brillant, double paroi, avec pince à glaçons

	□ cm	↑ cm	ltr.	€
36013 6	Ø 12	14	1	29,00



mit Eiszange

**Eiseimer-Set mit Eiszange**  
**ice bucket set with tong**  
**cubitera clásica con pinza**  
**seau à glaçons classique avec pince**



hochglanzpoliert, edler Kunststoffmantel, inkl. Edelstahl-Eiszange und Abtropfgitter mit Tragebügel, speziell isolierter Kunststoffeinsatz sorgt für beste Kühlung  
mirror polished finish, noble plastic jacket, highly plated, incl. stainless steel tong and drainer, with handle, special insulated plastic insert for best cooling

exterior de plástico de alta calidad de aspecto metálico mate, incluye pinza de inox, plástico interior aislante especial

plastique aspect métal brillant, bonne qualité, avec pince inox et égouttoir, paroi intérieure spécialement isolante

	□ cm	↑ cm	ltr.	€
36015 0	Ø 14	22	1,3	24,00



36024  
3 Liter

mit Eiszange

36022  
1,5 Liter

**Eiseimer mit Eiszange**  
**ice bucket**  
**cubitera**  
**seau à glaçons**



edler Kunststoffmantel in matt-metall Optik, Rand hochglanzpoliert, Tragebügel transparent, speziell isolierter Kunststoffeinsatz sorgt für beste Kühlung, Kunststoffdeckel klar

noble plastic jacket in satin metal look, with mirror polished finish edge, handle transparent, special insulated plastic insert, transparent plastic cover

plástico aspecto metálico satinado, borde brillante, asa transparente, interior plástico aislante especial, tapa de plástico transparente

plastique aspect métal satiné, bord brillant, anse transparente, paroi intérieure spécialement isolante, couvercle transparent

	□ cm	↑ cm	ltr.	€
36022 8	Ø 15	15	1,5	20,00
36024 2	Ø 20	18	3	23,50



36029  
3 Liter

mit Eiszange

36027  
1,5 Liter

**Eiseimer mit Eiszange**  
**ice bucket**  
**cubitera**  
**seau à glaçons**



weißer Kunststoffmantel, Kunststoff-Tragebügel, speziell isolierter Kunststoffeinsatz sorgt für beste Kühlung, Kunststoffdeckel klar, inkl. Eiszange

white plastic jacket, plastic handle, special insulated plastic insert, for best cooling, transparent plastic cover, incl. tong

cubitera blanca, asa de plástico blanco, interior aislante especial con tapa transparente, con pinza

seau à glaçons, anse en plastique blanc, paroi intérieure spécialement isolante, couvercle transparent, avec pince

	□ cm	↑ cm	ltr.	€
36027 3	Ø 15	15	1,5	16,90
36029 7	Ø 20	18	3	23,00

**NEW**



36004



36003

**Mini-Eiseimer / Mini-Sektkühler**  
**ice bucket**  
**cupitera clásica**  
**seau à glaçons classique**



ideal zum Servieren kleiner Mengen Eiswürfel oder zum Aufbewahren im Bar-/Thekenbereich  
 ideal for serving small amounts of ice cubes or for storing in the bar/counter area  
 ideal para servir pequeñas cantidades de cubitos de hielo o para almacenar en el bar/la barra  
 idéal pour servir de petites quantités de cubes de glace ou pour le stockage dans le bar/comptoir

	□ cm	↑ cm	litr.	€
36003 7	Ø 10,5	10	0,65	8,00
36004 4	Ø 13	13	1,0	10,00



**5 Liter**  
**8 Liter**

**2 Größen / 2 sizes**

**Eisbox „MAXI“**  
**ice box**  
**cupitera**  
**seau à glaçons**



Aluminium eloxiert  
 aluminium anodised  
 aluminio anodizado  
 aluminium anodisé

	□ cm	↑ cm	litr.	€
36033 4	Ø 18,5	20	5	38,00
36037 2	Ø 27	20	8	49,00

designed by **CULTURE FORM**



**5,4 Liter**

**Eisbox**  
**icebox**  
**cupitera**  
**seau à glaçons**



mit herausnehmbarem Tropfeinsatz  
 with drainer  
 plástico interior aislante especial  
 égouttoir

	□ cm	↑ cm	litr.	€
93220 3	27 x 27	15	5,4	41,00



**3,4 Liter**

**Inneneinsatz trennt Wasser und Eis**

**Eisbox**  
**icebox**  
**cupitera**  
**seau à glaçons**



Lieferung ohne Schaufel und Eiszerkleinerer  
 delivery without scoop  
 se entrega sin pala  
 livré sans la pelle

	□ cm	↑ cm	litr.	€
93200 5	20 x 20	17	3,4	28,00



**Glasumrander**  
**glass rimmer**  
**ribeteador de vasos**  
**borneur à verres „rimmer“**



Schwamm für Limettensaft, 2 Fächer für Zucker und Salz  
 with sponge for lime juice, 2 cases for sugar and salt  
 con esponja para zumo de lima, 2 compartimentos para azúcar y sal  
 avec éponge et 2 compartiments pour sucre et sel

	□ cm	●	€
93175 6	20 x 7,5	●	9,00



**Eiszerkleinerer**  
**Ice crusher**  
**picadora de hielo**  
**broyeur à glaçons**



inkl. Behälter und Eisschaufel, mit Edelstahl-Messer, glänzend  
 with container and ice scoop, stainless cutters  
 con depósito y pala para el hielo, metal cromado  
 avec tiroir récupérateur et pelle, métal chromé

	□ cm	↑ cm	€
36009 9	16 x 13	27	41,00



**Eiszerkleinerer**  
**Ice crusher**  
**picadora de hielo**  
**broyeur à glaçons**



glasklar, mit Edelstahl-Messer  
 clear, stainless steel cutters  
 cuchillas de acero inoxidable  
 couteaux inox

	□ cm	↑ cm	€
36017 4	12 x 12	24	15,00



Ø 5,5 cm

**Eis-Kugel-Former**  
**ice ball former**  
**molde de cubitos de hielo esféricos**  
**moule à glaçons en boules**



2 tlg., 3 Kugeln à 100 ml  
 3 bowls à 100 ml  
 3 bolas de 100 ml  
 3 boules à 100 ml

	□ cm	↑ cm	€
12990 0	23,5 x 8,5	6,5	9,90



**einfach mit Wasser füllen**  
**und gefrieren lassen**



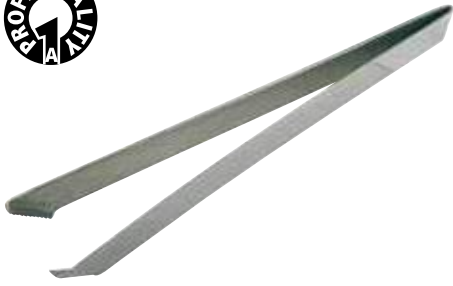

**Eiszange**  
**ice tong**  
**pinza para cubitos de hielo**  
**pince à glaçons**



matt poliert, mit griffigem Ende, ideal für Eiswürfel und Obstscheiben  
satin polished finish, with handy end, ideal for ice cubes and fruit slices  
pulido satinado, forma ergonómica ideal para cubitos de hielo y láminas de fruta  
poli mat satiné, forme ergonomique idéale pour glaçons et fruits tranchés

	cm	→ cm	€
93190 9	2 x 1,5	20	5,80



**Eiszange**  
**ice cube tong**  
**pinza para cubitos de hielo**  
**pince à glaçons**



hochglanzpoliert, fugenlos  
mirror polished finish, seamless  
pulido acabado brillante, de una sola pieza  
brillant, d'une seule pièce

	cm	→ cm	€
75805 6	5 x 2	17,5	2,00



**Eisschaufel**  
**ice scoop**  
**pala para cubitos de hielo**  
**pelle à glaçons**



	cm	→ cm	ltr.	€
93192 3	10 x 6	29	0,7	7,80



**Eisschaufel**  
**ice scoop**  
**pala para cubitos de hielo**  
**pelle à glaçons**



gelocht, ideal zum Befüllen von schlanken Gläsern, Schmelzwasser fließt zurück in die Eisbox  
perforated, ideal to fill narrow glasses, melt water flews back into the ice box  
perforada, ideal para llenar vasos estrechos, el agua derretida cae en la caja de hielo  
perforée, idéale pour verser les glaçons dans des verres étroits, l'eau retombe dans le bac à glaçons

	cm	→ cm	€
93191 6	Ø 5	19	6,50



**Eiszerkleinerer**  
ice chipper  
pick hielo  
casse-glace



mit 6 Zinken  
with 6 prongs  
con 6 dientes  
avec 6 broches

	cm	→ cm	€
93194 7	6,5 x 2,0	23,0	6,90



**Eiszerkleinerer**  
ice chipper  
pick hielo  
casse-glace



mit 6 Zinken  
with 6 prongs  
con 6 dientes  
avec 6 broches

	cm	→ cm	€
93193 0	Ø 2	19,5	3,50



93306



93307

**Schneidebrett „BAR“**  
cutting board  
tabla para cortar  
planche à découper



HDPE, mit Safrinne, mit Antirutsch-Füßchen  
HDPE, with juice groove and non-slip feet  
HDPE, con ranura para líquidos y pies antideslizantes  
HDPE, avec rigole et pieds antidérapants

	cm	↑ cm	€
93306 4	30 x 20	2	39,00
93307 1	50 x 30	2	54,00



rutschfest  
non-slip



**Cocktailmesser**  
bar knife  
cuchillo para cóctel  
couteau cocktail



mit 2 Zinken zum Aufspießen von Zitrusseiben  
with 2 prongs to pick up slices of lemon  
con 2 dientes para pinchar las rodajas de limón, etc.  
avec 2 dents pour les rondelles de citron et autres décorations

	→ cm	€
88846 3	21	3,80

NEW



**Stößel  
muddler  
mortero  
pilon muddler plastique**



grober Stößel, zum Auspressen von Früchten und Zerstoßen von Würfelzucker  
coarse notched, to press fruits or pound lump sugar  
mortero grueso con muescas para exprimir frutas y machacar azucarillos  
muddler grand format avec bout relief étoile pour presser les fruits ou le sucre en morceaux

	cm	→ cm	€
93316 3	Ø 3,5	23	9,00



**Stößel „BIG“  
muddler  
mortero  
pilon muddler „BIG“**



POM mit Edelstahl-Kappe, flacher, glatter Stößel, zum Auspressen von Früchten und Zerstoßen von Würfelzucker  
flat surface, to press fruits or pound lump sugar  
superficie lisa para exprimir frutas y machacar azucarillos  
muddler grand format avec bout lisse pour presser les fruits ou le sucre en morceaux

	cm	→ cm	€
93183 1	Ø 4,5	25	14,90



**Stößel  
muddler  
mortero  
pilon muddler plastique**



grober Stößel, zum Auspressen von Früchten und Zerstoßen von Würfelzucker  
coarse notched, to press fruits or pound lump sugar  
mortero grueso con muescas para exprimir frutas y machacar azucarillos  
muddler grand format avec bout relief étoile pour presser les fruits ou le sucre en morceaux

	cm	→ cm	€
93182 4	Ø 4	24	7,00



**Stößel  
muddler  
mortero  
pilon de bar**



mit griffigem Ende, zum Auspressen von Früchten und Zerstoßen von Würfelzucker  
with handy end, to press fruits or pound lump sugar  
acabado relieve para prensar frutas o azúcar  
avec relief grillagé pour presser les fruits ou le sucre en morceaux

	cm	→ cm	€
93180 0	Ø 2,5	21	3,30
93181 7	Ø 2,5	21	3,30



**NEW**

400 ml



700 ml

93140



400 ml

93201

**Boston Shaker**  
boston shaker  
coctelera boston  
shaker boston



2-teilig: Edelstahlbecher, 700 ml + Glas, 400 ml, außen verkupfert  
2 pcs. set: shaker, 700 ml + glass, 400 ml, stainless steel, copper look  
conjunto de 2 piezas: vaso coctelero, 700 ml + vaso de vidrio, 400 ml  
2 pièces: bol mélangeur, 700 ml + bol en verre, 400 ml

	□ cm	↑ cm	ltr.		€
93201 2	Ø 9	30	0,70 / 0,40	● Kupfer /copper	15,00
93140 4	Ø 9	30	0,70 / 0,40		13,00

**Einzelteile / spare parts / piezas sueltas / pièces détachées**

Ersatzglas / spare glass / vaso de recambio / verre de rechange

	□ cm	↑ cm	ltr.	€
93138 1	Ø 8,5	14,5	0,4	8,40



93139

400 ml



93136

700 ml



93137

**Boston Shaker**  
boston shaker  
coctelera boston  
shaker boston



2-teilig: Becher, 700 ml, gummiert, rutschfest + Glas, 400 ml  
2 pcs. set: beaker, 700 ml, rubberrized, anti-slip + glass, 400 ml  
conjunto de 2 piezas: vaso coctelero con goma exterior 700 ml + vaso de vidrio 400 ml  
2 pièces: bol mélangeur inox extérieur plastifié couleur 700 ml + bol en verre 400 ml

	□ cm	↑ cm	ltr.		€
93139 8	Ø 9	30	0,7	●	13,60
93136 7	Ø 9	30	0,7	●	13,60
93137 4	Ø 9	30	0,7	●	14,20

**Einzelteile / spare parts / piezas sueltas / pièces détachées**

Ersatzglas / spare glass / vaso de recambio / verre de rechange

	□ cm	↑ cm	ltr.	€
93138 1	Ø 8,5	14,5	0,4	8,40



Ø 8 cm



11,5 cm

**Speed Shaker**  
boston shaker  
coctelera boston  
shaker boston



matt poliert, Größe oben Ø 8 cm, Größe unten Ø 6 cm  
satin polished finish, size top Ø 8 cm, size bottom Ø 6 cm  
pulido acabado satinado, arriba Ø 8 cm, medida abajo Ø 6 cm  
poli mat satiné, Ø sup. 8 cm, Ø inf. 6 cm

	□ cm	↑ cm	ltr.	€
36007 5	Ø 8	11,5	0,4	7,40

NEW



**Parisian Shaker**  
shaker  
coctelera  
shaker



mattiert  
satin polished finish  
acabado efecto satinado  
fini mat effet satin

	□ cm	↑ cm	ltr.	€
93179 4	Ø 9,5	24	0,7	16,00

NEW



93211  
500 ml

93212  
700 ml

**Shaker „CLASSIC“**  
shaker  
coctelera  
shaker



Edelstahlbecher, außen verkupfert  
stainless steel, copper look  
vaso coctelero  
bol mélangeur

	□ cm	↑ cm	ltr.	€
93211 1	Ø 8,5	20	0,5	16,50
93212 8	Ø 9,0	23	0,7	21,00



36010  
500 ml

36011  
700 ml

**Shaker**  
shaker  
coctelera  
shaker



hochglanzpoliert  
mirror polished finish  
acabado pulido brillante  
brillant

	□ cm	↑ cm	ltr.	€
36010 5	Ø 8,5	20	0,5	14,70
36011 2	Ø 9	23	0,7	19,00



93134

**Stößel / muddler  
mit gedrehtem Stiel****Bar-Löffel**  
bar spoon  
cucharilla de cóctel  
cuillère à cocktail

	→ cm	€
93134 3	27	4,80
<b>NEW</b> 93034 6	27	8,00

Kupfer / copper

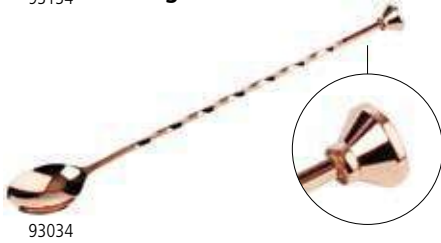

93034

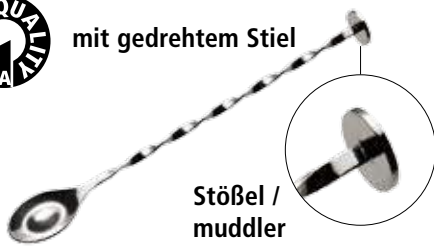

mit gedrehtem Stiel

**Stößel /  
muddler****Bar-Löffel**  
bar spoon  
cucharilla de cóctel  
cuillère à cocktail

	→ cm	€
93128 2	27	7,40

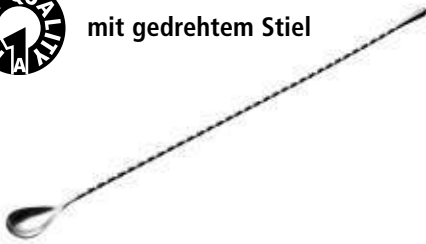

mit gedrehtem Stiel

**Bar-Löffel**  
bar spoon  
cucharilla de cóctel  
cuillère à cocktail

	→ cm	€
93153 4	40	4,90

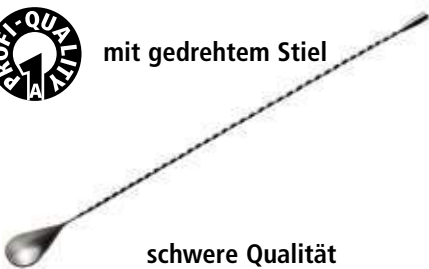

mit gedrehtem Stiel

**schwere Qualität  
heavy quality****Bar-Löffel**  
bar spoon  
cucharilla de cóctel  
cuillère à cocktail

	→ cm	€
93129 9	44	8,80

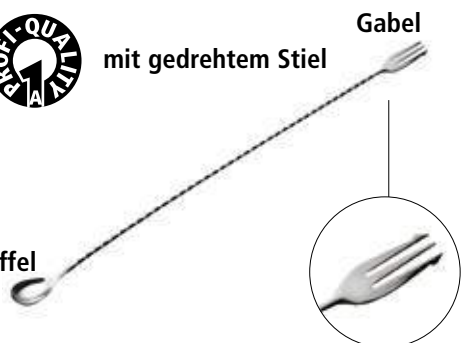

mit gedrehtem Stiel

**Gabel****Löffel****Bar-Löffel / -Gabel**  
bar spoon / fork  
cucharilla / tenedor de cóctel  
cuillère / fourchette à cocktail

	→ cm	€
93152 7	50	7,20

NEW



Rührglas mit Lippe  
mixing glass with lip  
vaso mezclador vertedor con pico  
verre mélangeur avec bec verseur



	□ cm	↑ cm	ltr.	€
93141 1	Ø 9	16,5	0,5	14,00



Rührglas mit Lippe  
mixing glass with lip  
vaso mezclador vertedor con pico  
verre mélangeur avec bec verseur



schwere Qualität  
heavy quality  
alta calidad  
qualité renforcée

	□ cm	↑ cm	ltr.	€
93101 5	Ø 11,5	19	0,95	14,20



Pitcher „CLASSIC“  
pitcher  
jarra  
pichet



	□ cm	↑ cm	ltr.	€
93105 3	Ø 13	21	1,5	8,40



NEW



Barsieb  
bar strainer  
colador de cóctel  
tamis cocktail



	□ cm	Grifflänge cm	€
93318 7	Ø 8,5	11,5	3,50

NEW



**Barsieb  
bar strainer  
colador de cóctel  
tamis cocktail**



hochglanzpoliert, Spiralfeder hält Eiswürfel beim Abseihen zurück, Feder kann zur Reinigung entnommen werden, passend für alle Gläser und Shaker

mirror polished finish, coil spring keeps ice cubes in shaker, spring can be taken off for cleaning, suitable for all glasses and shakers

pulido acabado brillante, con muelle para mantener los cubitos en la coctelera, el muelle se desmonta para limpiar, se adapta a todos tipos de vasos y cocteleras

brillant, avec ressort pour garder les glaçons dans le shaker, ressort démontable pour lavage, s'adapte à tous types de verres mélangeurs et shakers

	□ cm	→ cm	€
93312 5	Ø 9,5	18,0	10,50

HOT PRICE



**Barsieb  
bar strainer  
colador de cóctel  
tamis cocktail**



hochglanzpoliert, Spiralfeder hält Eiswürfel beim Abseihen zurück, Feder kann zur Reinigung entnommen werden, passend für alle Gläser und Shaker

mirror polished finish, coil spring keeps ice cubes in shaker, spring can be taken off for cleaning, suitable for all glasses and shakers

pulido acabado brillante, con muelle para mantener los cubitos en la coctelera, el muelle se desmonta para limpiar, se adapta a todos tipos de vasos y cocteleras

brillant, avec ressort pour garder les glaçons dans le shaker, ressort démontable pour lavage, s'adapte à tous types de verres mélangeurs et shakers

	□ cm	→ cm	€
93300 2	Ø 11,0	15,0	5,00

NEW



**Julep Barsieb „SIMPLE“  
julep strainer  
colador de cóctel  
tamis cocktail**



	□ cm	→ cm	€
93305 7	Ø 8,0	15,5	2,40

NEW



**Julep Barsieb „PRO“  
julep strainer  
colador de cóctel  
tamis cocktail**



hochglanzpoliert

mirror polished finish

acabado pulido brillante

fini poli brillant

	□ cm	→ cm	€
93313 2	Ø 7,5	18,0	8,60

rutschfest,  
„Einhandgebrauch“



**NEW**



**Cocktail-Doppelmaß  
Japanese jigger  
medidor  
measure double „jigger“**



	□ cm	↑ cm	cl		€
93164 0	Ø 4	11	2,5 / 5	stainless steel	8,00
93165 7	Ø 4	11	2,5 / 5	● copper	12,00

mit Füllstrich  
3,5 cl / 1,5 cl

93165



**Cocktail-Doppelmaß  
jigger  
medidor „jigger“  
measure double „jigger“**



	□ cm	↑ cm	cl	€
93120 6	Ø 4,5 / 4	7,0	2 / 4	4,60



**Cocktail-Doppelmaß  
jigger  
medidor „jigger“  
measure double „jigger“**



	□ cm	↑ cm	cl	€
93121 3	Ø 4 / 3,5	8,5	2 / 4	5,00
93112 1	Ø 4	8,5	2,5 / 5	5,40

93121

93112



**Cocktail-Doppelmaß  
jigger  
medidor „jigger“  
measure double „jigger“**



hochglanzpoliert, schnelles und genaues Abmessen von Spirituosen  
mirror polished finish, quick and exact measuring of spirits  
rápida y exacta medición de licores y otros ingredientes  
mesure exacte et rapide pour alcool et autres ingrédients

	□ cm	↑ cm	cl	€
93116 9	Ø 6 / 5	6	2 / 4	4,20

**NEW**

**Limetten- / Zitronenpresse**  
**lime- / lemonpress**  
**exprimidor de limón / lima**  
**presse citron**



	cm	cm		€
93214 2	21 x 7	5	●	13,00



93214  
 zwei Pressringe  
 für Zitronen  
 und Limetten

Durch einfache Hebeltechnik entsteht kein großer Aufwand beim Auspressen von Zitronen oder Limetten!



**Limettenpresse**  
**lime press**  
**prensa de limón**  
**presse citron**



	cm	cm		€
93189 3	21 x 7	5	●	11,00
<b>NEW</b> 93213 5	21 x 7	5	●	11,00

93189

Limette teilen, flache Seite in die Pressenhälfte legen und Saft auspressen



93213



93213

**NEW**



**Zitrusteiler**  
**citrus wedger**  
**cortador de cítricos**  
**coupe-agrumes**



mit Antirutsch-Füßchen, 2-teilig, Griffelement zur sicheren Bedienung mit innenliegendem Schneidmesser, teilt Zitrusfrüchte in Achtel, leicht unter fließendem Wasser zu reinigen  
with non-slip feet, 2 pieces, handle for safe use and with internal cutting knife, cut citrus fruits in eight pieces, easy to clean with water

con pies antideslizantes, 2 piezas, asas para un uso seguro y con cuchillas internas, divide los cítricos en ocho partes, fácil de limpiar con agua

avec pieds antiglissés, 2 pièces, anses pour une usage sûr avec des lames internes, divise les agrumes en huit pièces, facile à nettoyer avec de l'eau

	□ cm	↑ cm	€
93317 0	20 x 15	19	60,00

**Schneidaufteilung**

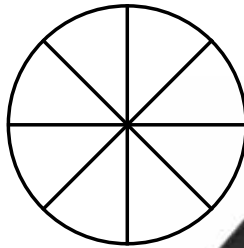

**Durch einfachen Druck  
leichte Teilung der Zitrus!**



**Zitruspresse**  
**citrus squeezer**  
**exprimidor cítricos**  
**presse-citron**



hochglanzpoliert, 2-teilig  
mirror polished finish, 2 pcs.  
pulido brillante, 2 piezas  
brillant, 2 pièces

	□ cm	↑ cm	ltr.	€
71431 1	Ø 12 / 17	10,5	0,35	12,90



**Zitruspresse „PROFI“**  
**juicer**  
**exprimidor**  
**presse-agrumes**



Zinkdruckguß verchromt, sehr stabile Ausführung, müheloses Entsaften durch Hebelmechanismus, extra Ausgießtülle für tropffreies Pressen, Sieb fängt Kerne und Fruchtfleisch auf, möbelschonende GummifüÙe

zinc alloy chrome plated, stable and robust mechanism

fundición a base de aleación de zinc, cromado, alta calidad, reforzado y con mecanismo robusto y muy limpio, sin esfuerzo, pie revestido para no rallar la mesa de trabajo

fonte de zinc chromé, qualité renforcée, mécanique robuste et simple d'usage, sans effort

	▣ cm	↑ cm	€
36014 3	26 x 20	48	99,00

**Zitruspresse**  
**juicer**  
**exprimidor**  
**presse-agrumes**



Zinkdruckguß verchromt, mit Hebelmechanismus, äußerst standfest und robust, müheloses Entsaften durch Hebelmechanik, Sieb fängt Kerne und Fruchtfleisch auf, möbelschonende GummifüÙe

made from high quality steel, finished in chrome, stable and robust mechanism, non-scratching undersurface

super-profesional, fundición a base de aleación de zinc, cromado, alta calidad, reforzado y con mecanismo robusto y muy limpio, sin esfuerzo, pie revestido para no rallar la mesa de trabajo

super professionnel, fonte de zinc chromé, qualité renforcée, mécanique robuste et simple d'usage, sans effort

	▣ cm	↑ cm	€
36019 8	19 x 18	max. 56	54,00



**Abtropfmatte  
drip mat  
esterilla escurridora  
tapis égouttoir**



gerollt  
rolled  
enrollada  
roulée



	cm	Stärke mm		€
93314 9	60 x 300	3	○ clear	16,00
93315 6	60 x 300	3	● black	16,00



**Abtropfmatte  
drip mat  
esterilla escurridora  
tapis égouttoir**



erweiterbar durch Klick-Verbindung  
expandable  
las placas de fijan con clips  
avec clips de fixation

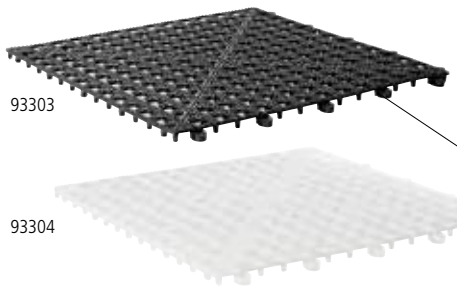

	cm	↑ cm		€
93303 3	33 x 33	1,5	● schwarz / black	4,90
93304 0	33 x 33	1,5	○ transparent	4,90

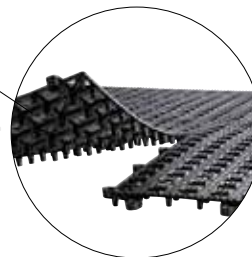

erweiterbar durch  
Klick-Verbindung  
expandable



**Bar-Matte  
drip mat  
tapete escurridor  
tapis de bar**



aus weichem Kunststoff, zum Abtropfen von Gläsern etc.  
soft plastic, to store and drain glasses  
plástico blando para escurrir vasos  
plastique souple, pour l'égouttage des verres



	cm	↑ cm		€
93166 4	30 x 15	1	●	6,00
93167 1	45 x 31	1	●	18,00
93173 2	52 x 8	1	●	7,50
93168 8	60 x 8	1	●	8,00
93169 5	60 x 8	1	●	8,00

**NEW**



**Mini-Eiseimer / Mini-Sektkühler**  
**ice bucket**  
**cupitera clásica**  
**seau à glaçons classique**



ideal zum Servieren kleiner Mengen Eiswürfel oder zum Aufbewahren im Bar-/Thekenbereich  
 ideal for serving small amounts of ice cubes or for storing in the bar/counter area  
 ideal para servir pequeñas cantidades de cubitos de hielo o para almacenar en el bar/la barra  
 idéal pour servir de petites quantités de cubes de glace ou pour le stockage dans le bar/comptoir

	□ cm	↑ cm	ltr.	€
36003 7	Ø 10,5	10	0,65	8,00
36004 4	Ø 13	13	1,0	10,00

36004



**Bar-Set**  
**bar-set**  
**conjunto de bar**  
**set pour le bar**



matt poliert, 5-teilig: Barsieb + Eiszange + Öffner + Messer + Ständer  
 satin polished finish, 5 pcs. set: strainer + ice tong + opener + knife + stand  
 acabado pulido satinado, 5 elementos: colador, pinza para hielo, abridor, cuchillo, soporte  
 fini mat satiné, 5 pièces: passoire à cocktail, pince à glace, décapsuleur, couteau, rack support

	□ cm	↑ cm	€
36012 9	13 x 7	20	26,40



**Bar-Caddy**  
**bar caddy**  
**organizador de bar**  
**organisateur „bar caddy“**



Ordnungshilfe für Trinkhalme, Rührer, Servietten, Streichhölzer, etc., ohne Inhalt  
 to organize straws, stirrers, napkins, matches, etc.  
 para organizar pajitas, cucharillas, servilletas, cerillas, etc.  
 pour bien organiser les pailles, agitateurs, cuillers, serviettes et autres accessoires

	□ cm	↑ cm	●	€
93174 9	24 x 15	11	●	6,80



**Zutatenbehälter**  
**condiment holder**  
**dispensador de especias**  
**boîte à fruits et ingrédients**



500 ml Inhalt pro Fach, 6 Fächer, inkl. Deckel (gefrostet) zur Lagerung  
 6 chambers à 50 ml, incl. lid for storing  
 6 compartimentos de 50 ml., incluye tapa para el almacenaje  
 6 compartiments de 50 ml chacun, avec couvercle pour le stockage

	□ cm	↑ cm	●	€
93171 8	50 x 16	10	●	19,00

NEW



**Kellnermesser „PROFI“**  
waiter's corkscrew  
sacacorchos de camarero  
tire-bouchons

HOLZ  
WOOD

EDELSTAHL  
STAINLESS  
INOX



leichtgängige Teflon-Spirale, mehrstufige Klapphebelfunktion, am Kopf angebrachtes Messer  
easy moving teflon coil, 2-stage opening system, knife at the top end  
mecha de teflón, sistema de apertura en 2 golpes, con cuchillo en la parte superior  
mèche téflon, ouverture en 2 étapes, couteau dans la partie supérieure

	→ cm	€
93302 6	11,5	9,90

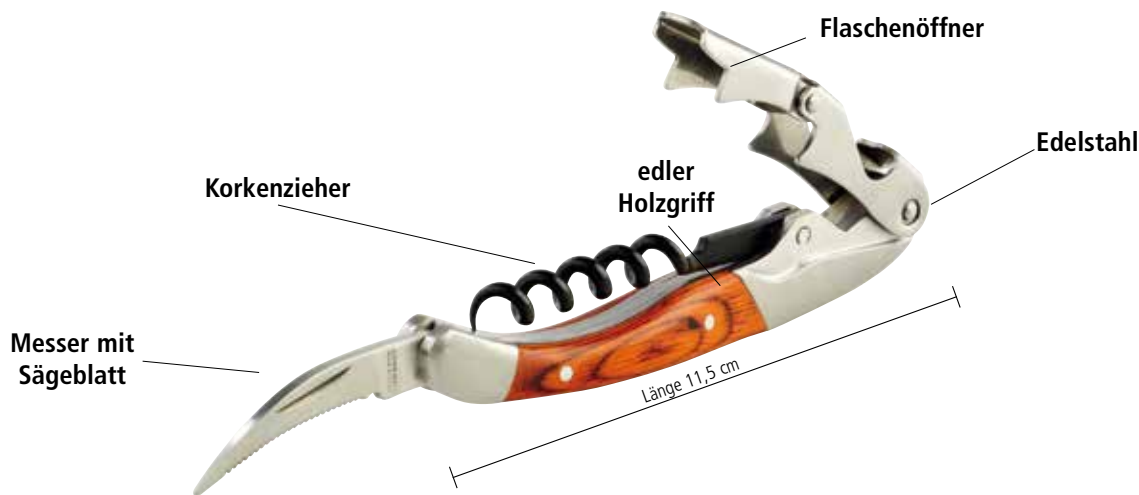

**Kellnermesser**  
waiter's corkscrew  
sacacorchos de camarero  
tire-bouchons

EDELSTAHL  
STAINLESS  
INOX



leichtgängige Teflon-Spirale, mehrstufige Klapphebelfunktion, am Kopf angebrachtes Messer  
easy moving teflon coil, 2-stage opening system, knife at the top end  
mecha de teflón, sistema de apertura en 2 golpes, con cuchilla en la parte superior  
mèche téflon, ouverture en 2 étapes, couteau dans la partie supérieure

	→ cm	€
93301 9	12	4,80



**Kellner-Flaschenöffner**  
waiter's barblade  
abridor camarero  
décapsuleur

EDELSTAHL  
STAINLESS  
INOX



matt poliert  
satin polished finish  
pulido acabado mate  
poli mat

	cm	€
93122 0	18 x 4	4,90



mit Gummierung

**Kellner-Flaschenöffner**  
waiter's barblade  
abridor camarero  
décapsuleur

EDELSTAHL  
STAINLESS  
INOX



	cm	€
93125 1	11 x 4	3,90



**Korkenzieher**  
**corkscrew**  
**sacacorchos**  
**tire-bouchons**



durch die ausgefeilte Technik und den großen Holzhebel lässt sich eine Weinflasche mühelos mit zwei schnellen Bewegungen öffnen, schwere Profi-Qualität, Grifflänge 13,5 cm  
a wine bottle can easily be opened with two quick actions due to the sophisticated technique and the large wooden lever, heavy professional quality, handle length 13,5 cm  
para profesionales de la gastronomía y del vino, una botella se abre fácilmente con sólo dos gestos, gracias a un eficaz mecanismo y a una palanca de 13,5 cm, alta calidad profesional  
une bouteille s'ouvre simplement en 2 gestes avec son mécanisme sophistiqué et pratique, avec un levier de 13,5 cm, pour les professionnels de la gastronomie et du vin

	→ cm	€
93299 9	53	48,00



**Kronkorken-Sammelbehälter**  
**bottle cap holder**  
**recogedor de chapas**  
**bac récupérateur de capsules**



matt poliert, für die Wandmontage unterhalb des Kronkorkenöffners  
satin polished finish, for wall fastening beyond the opener  
para fijar en la pared debajo del abridor, para recoger las chapas  
à fixer au mur sous le décapsuleur mural

	▣ cm	↑ cm	€
93172 5	13,5 x 8	24	15,00



**Kronkorkenöffner**  
**bottle cap opener**  
**abridor de chapas de pared**  
**décapsuleur mural**



für die Wandmontage, aus massivem Metall  
for wall fastening, massive metal  
para fijación en la pared, metal macizo  
massif, à fixer au mur

	▣ cm	↑ cm	€
93124 4	7 x 8	2,5	9,90



**Tablett**  
**tray**  
**bandeja**  
**plateau**



mit gebördeltem, polierten Rand  
rolled and mirror polished edge  
borde redondeado acabado efecto espejo  
bord rond, effet miroir

	▣ cm	↑ cm	€
01336 0	Ø 35	3	26,00



zum Dosieren  
und Aufbewahren

6 Farben

1 ltr.



abnehmbarer Boden  
dient als Deckel

**Dosier- & Vorratsflasche**  
**pouring container**  
**botella „store & pour“**  
**bouteille „store & pour“**



4-teilig: Behälter + Flaschenhals + Schraubdeckel + Ausgießer Ø 11 mm mit Luftzufuhr für gezieltes Ausgießen, zum Dosieren und Aufbewahren

4 pcs. set: for storage, mixing and serving drinks, nozzle Ø 11 mm

set de 4 piezas: para almacenar y servir mezclas y bebidas, agujero de Ø 11 mm

se compose de 4 pièces: idéal pour servir et pour conserver les boissons, embout Ø 11 mm

	□ cm	↑ cm	ltr.		€
93144 2	Ø 9	33	1	● gelb / yellow	4,60
93145 9	Ø 9	33	1	● rot / red	4,60
93146 6	Ø 9	33	1	● grün / green	4,60
93147 3	Ø 9	33	1	○ klar / clear	4,60
93148 0	Ø 9	33	1	● orange	4,60
93149 7	Ø 9	33	1	● braun / brown	4,60

6 Farben

2 ltr.



zum Dosieren  
und Aufbewahren

**Dosier- & Vorratsflasche**  
**pouring container**  
**botella „store & pour“**  
**bouteille „store & pour“**



4-teilig: Behälter + Flaschenhals + Schraubdeckel + Ausgießer mit Luftzufuhr für gezieltes Ausgießen, zum Dosieren und Aufbewahren

4 pcs. set: for storage, mixing and serving drinks

set de 4 piezas: para almacenar y servir mezclas y bebidas

se compose de 4 pièces: idéal pour servir et pour conserver les boissons

	□ cm	↑ cm	ltr.		€
94144 1	Ø 12,5	35	2,0	● gelb/yellow	6,20
94145 8	Ø 12,5	35	2,0	● rot/red	6,20
94146 5	Ø 12,5	35	2,0	● grün/green	6,20
94147 2	Ø 12,5	35	2,0	○ klar/clear	6,20
94148 9	Ø 12,5	35	2,0	● orange	6,20
94149 6	Ø 12,5	35	2,0	● braun / brown	6,20



1 ltr.

**Dosier- & Vorratsflasche**  
**pouring container**  
**botella „store & pour“**  
**bouteille „store & pour“**



4-teilig: Behälter + Flaschenhals + Schraubdeckel + Ausgießer Ø 11 mm mit Luftzufuhr für gezieltes Ausgießen, zum Dosieren und Aufbewahren

4 pcs. set: for storage, mixing and serving drinks, nozzle Ø 11 mm

set de 4 piezas: para guardar, para mezclar y servir bebidas, boquilla Ø 11 mm

se compose de 4 pièces: idéal pour servir et pour conserver les boissons, embout Ø 11 mm

	☐ cm	↑ cm	ltr.	pcs.	€
93143 5	Ø 9	33	1	4 ●	6,90



für 0,2 - 0,3 ltr.

**Bierglasträger**  
**beer rack**  
**porta vasos de cerveza**  
**porte verres à bière**



für Glasgrößen 0,2 - 0,3 Liter, für 10 Gläser, Ring Ø 6,5 cm

for glasses size 0,2 - 0,3 liter, for 10 glasses, ring Ø 6,5 cm

para vasos tamaño 0,2-0,3 l, para 10 vasos, Ø 9,5 cm

pour verres de 0,2 à 0,3 l, pour 10 verres, Ø 9,5 cm

	☐ cm	↑ cm	€
00632 4	40 x 16,5	29	17,00



**Flaschenträger**  
**bottle rack**  
**porta botellas**  
**porte-bouteilles**



für 6 Flaschen, Ring Ø 9,5 cm

for 6 bottles, ring Ø 9,5 cm

para 6 botellas, Ø 9,5 cm

pour 6 bouteilles, Ø 9,5 cm

	☐ cm	↑ cm	€
00630 0	32 x 21,5	32,5	11,20



**Gläserchiene**  
**glass rack**  
**rack de copas**  
**rack porte-verres**



aus 6 mm verchromten Draht, Wand- und Deckenmontage möglich, bietet Platz für 20 Gläser

6 mm chrome plated wire, can be mounted under a shelf or on the wall, for 20 glasses

alambre cromado de 6 mm, puede instalarse bajo una estantería o en la pared para 20 copas

fil chromé de 6 mm, à installer sous une étagère ou contre un mur, pour 20 verres à pied

	☐ cm	↑ cm	€
93400 9	45 x 32	6	29,00



**Rezeptionsglocke**  
**ring bell**  
**timbre**  
**sonnette**



	☐ cm	↑ cm	€
71400 7	Ø 8,5	6	4,00
71433 5	Ø 10	6,5	6,00

**NEW**



**2er Set Ausgießer „STEADY SPOUT“**



Konstanter Durchfluss ohne Spritzer beim An- oder Absetzen durch patentierte Technologie, Ausgießer verfügt über unterschiedlich große Lamellen, die auf Flaschen mit einem Innendurchmesser von 18 bis 21,5 mm eingesetzt werden können. Nach Reinigung mit Warmwasser springt der Korken in die Ausgangsform zurück (Memory-Effekt).

Due to the patented technology you will have a constant flow and no splashing when turning and tipping the bottle, spout has different sizes of slats, which can be used on bottles with an internal diameter of 18 to 21,5 mm. After cleaning with hot water, the cork will return in its original shape (memory effect).

Gracias a la tecnología patentada el flujo es constante sin salpicar al servir, el surtidor ofrece listones de diferentes tamaños, que pueden ser utilizados en botellas con un diámetro interno de 18 a 21,5 mm. Después de la limpieza con agua caliente el corcho salta a su forma original (efecto memoria).

Grâce à la technologie brevetée le débit est constant sans éclaboussures lors du démarrage ou de l'arrêt, le bec offre lattes de tailles différentes, qui peuvent être utilisés sur les bouteilles d'un diamètre intérieur de 18 à 21,5 mm. Après avoir nettoyé à l'eau chaude, le bouchon en liège saute à sa forme originale (effet mémoire).

	↑ cm	pcs.	€
93319 4	10,5	2	6,40



**Permanent-Ausgießer, 6er Set  
free flow pourers, 6 pcs. set  
vertedores continuos set 6 piezas  
set de 6 bouchons verseurs continus**



	↑ cm	pcs.	€
93110 7	11	6	12,50
<b>NEW</b> 93320 0	11	6	mit Verschluss / Kappe 15,00



**Permanent-Ausgießer, 6er Set  
free flow pourers, 6 pcs. set  
vertedores continuos set 6 piezas  
set de 6 bouchons verseurs continus**



	↑ cm	pcs.	€
93114 5	8	6	11,80



**Permanent-Ausgießer, 2er Set  
free flow pourers, 2 pcs. set  
vertedores continuos set 2 piezas  
set de 2 bouchons verseurs continus**



Portionierer 2 cl, schnelles und genaues Abmessen

2 cl, quick and exact measuring

2 cl. medición rápida exacta

2 cl mesure exacte et rapide

	↑ cm	pcs.	€
93115 2	10	2	13,00

**NEW**



93309



93308

**Spritzflasche inklusive Ausgießer**  
**squeeze bottle with nozzle**  
**botella exprimible con dosificador**  
**flacon pulvérisateur avec bec verseur**



ideal für Bitter-Liköre  
 perfect for bitter liqueur  
 perfecto para amargo licor  
 pour amaro liquore

	□ cm	↑ cm	ltr.	€
93308 8	6 x 5	20	0,2	12,00

**Einzelteile / spare parts / piezas sueltas / pièces détachées**

Ausgießer passend für Spritzflasche / nozzle suitable for squeeze bottle  
 dosificador apto para botella exprimible / bec verseur approprié pour flacon pulvérisateur

93309 5	Ø 2,5	5,5		2,60
---------	-------	-----	--	------



**Permanent-Ausgießer, 6er Set**  
**free flow pourers, 6 pcs. set**  
**vertedores continuos set 6 piezas**  
**set de 6 bouchons verseurs continus**



à 2 Stück: blau, rot, gelb  
 2 pcs of each colour: blue, red, yellow  
 2 piezas de cada color: azul, rojo, amarillo  
 2 par couleur: bleu, rouge, jaune

	□ cm	↑ cm	pcs.	€
93111 4	Ø 3	7,5	6	4,70



**Flaschenhalterung mit Portionierer 2 cl**  
**shelf bracket with spirit measure 2 cl**  
**soporte 1 botella con medidor licores 2 cl**  
**support bouteille avec doseur 2 cl**



Portionierkopf aus Kunststoff mit verchromten Gehäuse, garantiert exakte Dosierung, geeignet für 0,7 - 2 Liter Flaschen, mit Schraubklemme  
 plastic with chrome plated body, guaranteed exact apportioning, usable for 0,7 - 2 liter bottles easily fixed at the rack/shelf by screw clamp  
 aluminio anodizado adaptador para botella hecho de plástico con cuerpo cromado, incluye proporcionador exacto de 2 cl, apto para botellas 0,7 a 2 l., fácil fijación brida en el estante  
 plastique et alu anodisé pour le corps, inclut doseur avec mesure exacte 2 cl, pour bouteille de 0,7 l à 2 l, fixation sur étagère par brida à visser

	□ cm	€
93298 2	32 - 45	52,00



**Champagnerverschluss**  
**champagne saver**  
**tapón vertedor**  
**bouchon verseur**



Einschenken ohne Tropfen, patentierter "Pull Down Bottle Grip", passt auf fast alle Standard Champagner- o. Sektflaschen  
 non drip serving pourer, patented "Pull Down Bottle Grip", fits most champagne bottles  
 anti goteo, patentado, apto para la mayoría de botellas de cava o champagne  
 anti-goutte, modèle déposé, apte pour la plupart de bouteilles de champagne

	□ cm	↑ cm	€
93135 0	5 x 5	8	12,00



**Schnappspistole**  
**booze pistol**  
**pistola de licores**  
**bouchon doseur à gâchette**



auch für zuckerhaltige, dünnflüssige Liköre, passend für handelsübliche Schnapsflaschen, luftdichter Verschluss, präzise Portioniermechanik 2 cl, einfache Reinigung in lauwarmen Wasser  
 useable for all commercial spirit bottles, including for sweet liqueurs or liquid alcohol, airtight closing, precise dosification 2 cl, easy to clean with warm water

apto para todos los espirituosos habituales, incluso muy dulces o muy líquidos, cierre hermético, dosificación precisa 2 cl, fácil de limpiar con agua templada

apte pour tous les spiritueux habituels du commerce, y compris très sucrés ou très liquides, fermeture hermétique, dosage précis 2 cl, lavage facile sous l'eau chaude

	cm	cm	€
93108 4	13 x 8		31,40



**Weinex-Ausgießer, 2er Set**  
**wine nozzle, 2 pcs. set**  
**vertedor de vino set de 2 piezas**  
**set de 2 becs verseurs**



breiter Auslaufstrahl für zügiges Ausschöpfen und Lüften junger Weine, integrierter Deckel öffnet die Flasche automatisch und verschließt sie wieder beim Abstellen, inkl. 2 Adapterhülsen

acrylic plastic, wide stream for easy flow and vent the wine, integrated lid opens and closes bottle automatically, incl. 2 adapters

acrílico baja altura para guardarlo mejor en la nevera, boca ancha para un mejor vertido y aireado del vino, la tapa integrada se abre y cierra automáticamente, la botella incluye 2 adaptadores

acrylique, hauteur réduite pour l'espace dans le frigo, embouchure large pour bien verser et en même temps oxygéner les vins jeunes, la valve intégrée s'ouvre et se ferme automatiquement, inclut 2 adaptateurs

	cm	cm	cm	€
93109 1	Ø 3	10		12,60

**Champagner- / Sektkonservator**  
**champagne conservator**  
**tapón conservador**  
**bouchon de conservation**



2-teilig: Überdruckpumpe + luftdichter Bügelverschluss mit Entlüftungsventil, Champagner und Sekt lassen sich nach dem Öffnen für längere Zeit frisch halten

2 pcs. set: overpressure pump + airtight swing-top with air valve, opened champagne and sparkling wine can be kept fresh for a longer time

set de 2 piezas: bomba a presión + tapón swing hermético con válvula de aire acero inox y plástico, el cava y las bebidas espumosas pueden conservarse y mantenerse por más tiempo.

set de 2 pièces: bombe à pression + bouchon swing hermétique avec valve - inox et plastique - enfin un moyen de conserver plus longtemps le champagne et autres vins mousseux

	cm	cm	cm	€
93126 8	Ø 4,5	12	●	23,00

**Einzelteile / spare parts / piezas sueltas / pièces détachées**

Verschluss einzeln / stopper single / tapón individual / bouchon seul

93127 5				12,60
---------	--	--	--	-------





Inhalt: 2 Stück  
"WINE"

**Wein-Verschlüsse, 2er Set**  
**wine stopper, 2 pcs. set**  
**2 tapones para vino**  
**2 bouchons pour le vin**



matt poliert, innen Kunststoff, mit Schriftzug „WINE“  
satin polished finish, inside plastic, with inscription „WINE“  
acabado pulido mate, interior de plástico con inscripción „WINE“  
poli mat satiné, intérieur plastique, avec inscription "WINE"

	☐ cm	↑ cm	pcs.	€
93206 7	Ø 4,3	4,5	2	8,00



Inhalt: 2 Stück

**Champagner-Verschlüsse, 2er Set**  
**stopper, 2 pcs. set**  
**tapón para el cava, set de 2 piezas**  
**set de 2 bouchons à champagne**



matt poliert, innen Kunststoff, mit Schriftzug  
satin polished finish, inside plastic, with inscription  
acabado pulido mate interior de plástico  
poli mat satiné, intérieur plastique avec inscription

	☐ cm	↑ cm	€
93207 4	Ø 4,5	4,5	8,20



**Sekt-Verschlüsse, 2er Set**  
**stopper, 2 pcs. set**  
**set de 2 tapones**  
**set de 2 bouchons**



hochglanzpoliert, innen Gummi Arabicum  
mirror polished finish, inside rubber arabicum, with inscription  
pulido acabado efecto brillante, interior goma arábica con inscripción  
brillant, intérieur gomme arabique

	☐ cm	↑ cm	pcs.	€
93160 2	Ø 4	6	2	8,20



**Wein-Verschluss**  
**wine stopper**  
**tapón para vino**  
**bouchon à vin**



matt poliert  
satin polished finish  
acabado pulido mate  
poli mat satiné

	☐ cm	↑ cm	€
93202 9	Ø 4,3	6,3	9,00



**Schlüsselschnur, 2er Set**  
**key cord, 2 pcs. set**  
**llavero enrollable**  
**porte-clés avec cable à enroulement**



Schnur 65 cm lang, Befestigung mit Klammer am Gürtel, starke Rückzugfeder  
 65 cm long cord, to fix at waistbelt, strong pull-back spring  
 65 cm longitud del cable para fijar en una hebilla, cable enrollable automático con muelle  
 longueur 65 cm, à fixer à la ceinture, enroulage automatique

	☐ cm	↑ cm		€
93170 1	Ø 4	2		7,00



**Wein-Vakuumpumpe**  
**vacuum wine pump**  
**bomba de vacío para vino**  
**pompe à vide pour le vin**



inkl. 2 Stopfen, um offene Flaschen erneut zu versiegeln und den Wein zu konservieren  
 incl. 2 stoppers, to reseal open wine bottles and conserve the wine  
 incluye 2 tapones para cerrar perfectamente las botellas abiertas y conservar el vino  
 livrée avec 2 bouchons pour refermer les bouteilles tout en conservant le vin parfaitement

	☐ cm	↑ cm		€
93123 7	Ø 3,5	15		17,90

**Einzelteile / spare parts / piezas sueltas / pièces détachées**

Weinpumpe-Ersatzstopfen, 2er Set / wine pump stopper, 2 pcs. set  
 tapones al vacío para el vino / set de 2 bouchons à vide pour le vin

93162 6	Ø 3	4,5	2 pcs.	4,60
---------	-----	-----	--------	------



**Staubkappen, 2er Set**  
**dust & fly cap, 2 pcs. set**  
**tapón antipolvo**  
**bouchon anti-poussières et anti-insectes**



schützt vor Staub und Insekten  
 protects for dust and insects  
 para proteger de la suciedad e insectos  
 pour protéger de la poussière et des insectes

	☐ cm	↑ cm	pcs.		€
93161 9	Ø 4	8	2	●	4,20



**Reinigungsbürste für Ausgießer**  
**pourer cleaning brush**  
**cepillo de limpieza para picos vertedores**  
**brosse lave-bouchons doseurs**



Abbildung in Originalgröße

	→ cm		€
93102 2	16,5		2,50

designed by **CULTURE FORM**

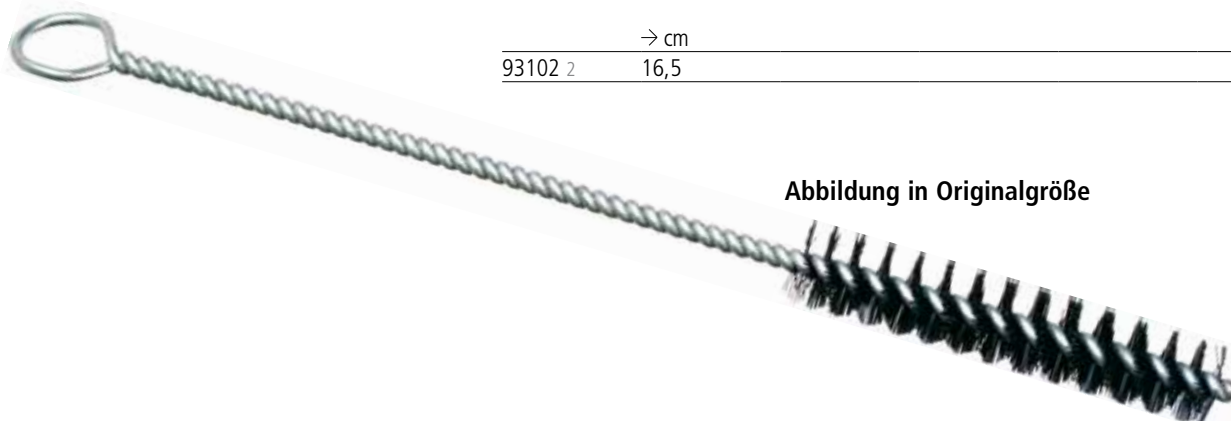

**Dressing-Station**

**Flaschen Display „SMALL“  
bottle display / serving stand  
expositor  
présentoir**



für 4 Flaschen, Edelstahl mattiert  
for 4 bottles, stainless steel satin polished finish  
para 4 botellas, satinado  
pour 4 bouteilles, inox mat satiné

	cm	cm	€
40400 7	42 x 15	19,5	29,00

designed by **CULTURE FORM**

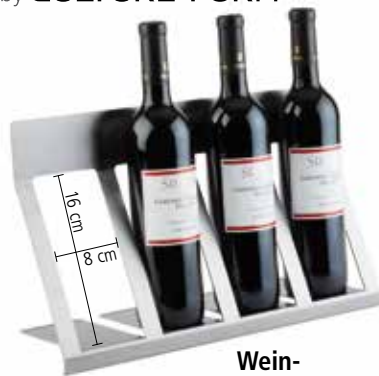

**Wein-Präsentation**

**Flaschen Display „LARGE“  
bottle display / serving stand  
expositor  
présentoir**



für 4 Flaschen, Edelstahl mattiert  
for 4 bottles, stainless steel satin polished finish  
para 4 botellas, satinado  
pour 4 bouteilles, inox mat satiné

	cm	cm	€
40401 4	46 x 15	19,5	34,00



**Weinflaschenhalter  
winebottle-stand  
soporte para botellas de vino  
porte-bouteille**



	cm	cm	€
30333 1	22 x 6	20,5	6,90



**Gläserhalter / Tellerclips, 25er Set  
glass plate clips, 25 pcs. set  
25 pinzas sujeta copas  
25 clips porte-verre**



zum Feststecken von Sekt- oder Weingläsern am Tellerrand, ideal für Empfänge, passend für alle gängigen Tellertypen und -größen, Größe innen Ø 3 cm  
to clip on a plate and hold a glass, ideal for parties, useable for all current plates, size inside Ø 3 cm

pinzas de plato para sujetar la copa, ideal para fiestas, válido para cualquier plato corriente, plástico blanco, medida interior Ø 3 cm

pince porte-verre à pied, à fixer sur le bord d'une assiette, idéale pour réceptions, s'adapte sur tous types d'assiettes, plastique blanc, Ø int. 3 cm

	cm	pcs.	€
00111 4	8	25	13,20



**NEW**



00582 - schwarz

**Windascher  
ashtray  
cenicero  
cendrier**

Metall verchromt, Glas gefrostet, mit Bajonettverschluss  
metal chrome plated, glass frosted, bayonet lock  
metal cromado, opaco mate, cierre de bayoneta  
métal chromé, mat, verrouillage par baïonnette



	□ cm	↑ cm		€
00582 2	Ø 9,5	8	●	7,90
00583 9	Ø 9,5	8	●	7,90
00584 6	Ø 9,5	8	●	7,90
00585 3	Ø 9,5	8	○	7,90



00583 - gelb



00584 - türkis



00585 - weiß



**Drehascher „KLASSIKER“  
ashtray  
cenicero  
cendrier giratoire**

Deckel mit Drehmechanismus  
with rotary button  
con botón giratorio  
tourne par pression sur le bouton



	□ cm	↑ cm	€
00054 4	Ø 13	10,5	7,90



**Drehascher „KLASSIKER“  
ashtray  
cenicero  
cendrier**

Deckel mit Drehmechanismus  
with rotary button  
con botón giratorio  
tourne par pression sur le bouton



	□ cm	↑ cm	€
00056 8	Ø 10,5	11	6,40



**Aschenbecher**  
ashtray  
cenicero  
cendrier



Deckel hochglanzpoliert, Behälter matt poliert, mit Windschutzdeckel  
lid mirror polished finish, container satin polished finish, with windcover  
con tapa antiviento pulida brillante y contenedor pulido efecto satinado  
couvercle anti-vent brillant, corps poli mat satiné

	☐ cm	↑ cm	€
00052 0	Ø 12	5,5	8,20



**Aschenbecher**  
ashtray  
cenicero  
cendrier



matt poliert, mit Windschutzdeckel  
satin polished finish, with windcover  
acabado pulido satinado apilable, tapa para el viento  
poli mat, empilable, couvercle anti-vent

	☐ cm	↑ cm	€
00090 2	Ø 10	4,5	7,60
00091 9	Ø 12	4,5	8,50



stapelbar



**Aschenbecher**  
ashtray  
cenicero  
cendrier



matt poliert, hochwertige schwere Ausführung  
satin polished finish, high quality, heavy gauge  
pulido satinado, alta calidad, apilable  
poli mat, empilable, belle qualité

	☐ cm	↑ cm	€
00048 3	Ø 8	3	7,40
00050 6	Ø 10	3	8,50

stapelbar

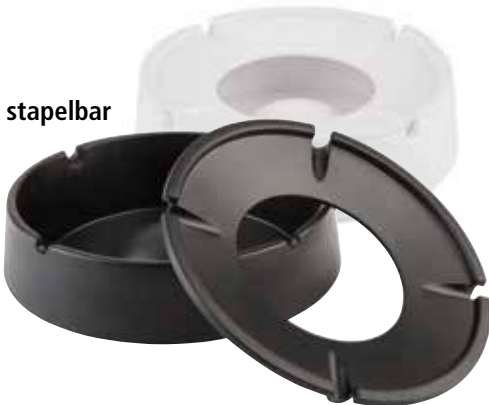

**Wind-Aschenbecher „XL“**  
ashtray  
cenicero  
cendrier



	☐ cm	↑ cm	●	€
84212 0	Ø 14,5	4,5	○	5,60
84213 7	Ø 14,5	4,5	●	5,60



83488

Wind-Aschenbecher „CASUAL“  
ashtray  
cenicero  
cendrier



	□ cm	↑ cm		€
83488 0	Ø 11,5	5	○	5,00
83489 7	Ø 11,5	5	●	5,00



83610

stapelbar



83613

Wind-Aschenbecher „CASUAL“  
ashtray  
cenicero  
cendrier



	□ cm	↑ cm		€
83610 5	Ø 10	4	○	4,20
83612 9	Ø 12	4,5	○	4,60
83611 2	Ø 10	4	●	4,20
83613 6	Ø 12	4,5	●	4,60



83616

stapelbar

Aschenbecher „CASUAL“  
ashtray  
cenicero  
cendrier



	□ cm	↑ cm		€
83614 3	Ø 9,5	4,5	○	2,50
83616 7	Ø 9,5	4,5	●	2,50



stapelbar

Aschenbecher „CASUAL“, 3er Set  
ashtray, 3 pcs. set  
set de cenicero 3 piezas  
set de 3 mini cendriers



	□ cm	↑ cm		pcs.	€
00576 1	Ø 8	3	●	3	2,20



matt poliert



stapelbar

Aschenbecher  
ashtray  
cenicero  
cendrier



	□ cm	↑ cm		€
00043 8	Ø 14	2,5		1,90
00044 5	Ø 16	2,5		2,30



**Standascher / Abfalleimer „SMOKERS POINT“**  
**floor standing ashtray**  
**cenicero de pie**  
**cendrier sur pied**



glanz poliert, mit herausnehmbaren Aschereinsatz  
 mirror polished finish, with ashtray insert and with litter bin  
 pulido acabado con cenicero y papelera  
 poli brillant inséré, extractible pour vidage facile

	cm	cm	litr.	€
00579 2	Ø 9 / 24 x 24	86	3	114,00



**3 ltr.**  
**Einsatz**

**Standascher „DIABOLO“**  
**standing ashtray**  
**cenicero de pie**  
**cendrier sur pied**



für den Innen- und Außenbereich, inkl. 1,5 kg Sand, eine Ascheschale für die Sandbefüllung und ein Metallsieb  
 for in,- outdoor use, included a bag of sand and a metal sieve  
 uso en interior o exterior, incluye una bolsa de arena y embudo de metal  
 usage en intérieur ou extérieur, livré avec un sac de sable et entonnoir métal

	cm	cm	€
00574 7	Ø 40	60	64,00



**vielseitig nutzbar!**



**zerlegbar und stapelbar!**



**Standascher / Abfalleimer**  
**litter bin / ashtray**  
**papelera con cenicero superior**  
**poubelle avec cendrier supérieur**

EDELSTAHL  
 STAINLESS  
 INOX

mit herausnehmbaren Aschereinsatz und herausnehmbaren verzinkten Innenbehälter / Eimer  
 with ashtray insert and litter bin  
 con cenicero y papelera metálica  
 cendrier et corbeille à détritius

	□ cm	↑ cm	€
00575 4	Ø 30	60	52,00

**HOT  
 PRICE**



**Tret-Beuthalter**  
**pedal bin**  
**soporte a pedal**  
**poubelle à pédale**

EDELSTAHL  
 STAINLESS  
 INOX

geeignet für Müllbeutel bis 120 ltr., 110 x 70 cm  
 suitable for bags up to 120 ltr., 110 x 70 cm  
 apto para bolsas hasta 120 l., medidas sin bolsa 110 x 70 cm  
 apte pour sacs de 120 l., dim. sans sac 110 x 70 cm

	□ cm	↑ cm	€
00580 8	59 x 43	96	114,00



**Gummilippe**  
 55 cm breit,  
 Abstand zwischen  
 Gummilippe und  
 Bodenblech 82 cm



**easy handling,**  
**step on bin**



**2 Lenkrollen mit Feststellern**  
**2 wheels with brakes**

**NEW**



**Kreide-Marker, Stärke 2mm, 2er Set**  
**chalk marker, 2 pcs.**  
**rotulador de tiza, 2 pz.**  
**marqueur a la craie liquide, 2 pc.**

Zum Gestalten und Beschriften von Tafeln, Glas und fast allen geschlossenen Oberflächen, deckende Flüssigkreide auf Wasserbasis, feucht abwischbar

For decorating and writing on boards, glass and almost all non-porous surfaces, opaque water-based liquid chalk, wet-wipeable

Rotuladores para pizarra de tiza líquida para decorar y escribir sobre pizarras, cristales y casi todas las superficies no porosas. Tiza líquida opaca al agua que se pueda borrar con un trapo

Pour décorations et inscriptions sur tableaux, verre et presque toutes les surfaces non poreuses, craie liquide opaque à base d'eau, effaçable avec un chiffon humide

	cm	cm		pcs.	€
71490 8	Ø 1	13	○ white	2	5,40
71491 5	Ø 1	13	● black	2	5,40

**NEW**



**Kartenhalter, 2er Set „KLAMMER“**  
**table stand, 2 pcs. set**  
**set de 2 piezas, soporte de mesa**  
**set de 2 pièces, support de table**

HOLZ  
WOOD

inkl. 30 Beschriftungskarten (15 x weiß, 15 x schwarz- ca. 10 x 8 cm)

incl. 30 cards (15 x white, 15 x black - 10 x 8 cm)

incluye 30 tarjetas (15 x blanco, 15 x negro - 10 x 8 cm)

includ 30 étiquettes (15 x blanc, 15 x noir - 10 x 8 cm)

	cm	cm		€
71487 8	4 x 2,5	10	● wood	12,00
71488 5	4 x 2,5	10	○ white	12,00
71489 2	4 x 2,5	10	● black	12,00



**Beschriftungskarten, 50 Stück**  
**card holder, 50 pcs. set**  
**set de porta cartelitos, 50 piezas**  
**set complet supports + 50 pièces**

passendes Zubehör für Artikel 71487, 71488, 71489

suitable accessories for 71487, 71488, 71489

accesorios a juego para 71487, 71488, 71489

accessoires assortis pour 71487, 71488, 71489

	cm		€
71498 4	10 x 8	○	4,00
71499 1	10 x 8	●	4,00

**NEW**



**Beschriftungskarten**  
**chalkboard labels**  
**etiquetas**  
**étiquettes**



12 Bögen mit je 6 Motiven, selbstklebend, mit wasserlöslichem Stift beschreibbar

12 sheets includes 6 self-adhesive and removable labels, use regular chalkboard markers and wipe clean with a damp cloth

12 hojas, cada una con 6 motivos autoadhesivos, se pueden marcar con un rotulador lavable con agua

12 feuilles chacune avec 6 motifs autoadhésifs, on peut écrire avec un stylo lavable à l'eau

	cm		€
00069 8	8,0 x 4,6	●	10,00



**10 Schilderhalter „FLEX CLIP“**  
**10 sign holders**  
**set de 10 clips**  
**set de 10 porte-étiquettes**



Durch die bewegliche Verbindung der Klemme und Schilderhalterung ein extrem flexibler Cliphalter!

multi angle ticket clip

inclinable con pinza

inclinable avec pince

→ cm

	cm		€
71472 4	9,5	○ elfenbein / ivory	12,60
71473 1	12,5	○ elfenbein / ivory	13,70
71474 8	9,5	●	12,00
71475 5	12,5	●	13,70

**Zubehör / spare parts / recambios / pièces de rechange**

passende Schilder, 10er Set / fitting signs, 10 pcs. set  
 set de 10 cartelitos / set de 10 étiquettes

	cm	pcs.	€
11879 9	7,7 x 5,2	10	4,90
12879 8	5,0 x 3,0	10	4,60

mit Kreide und  
 abwaschbarem  
 Stift beschriftbar



**Tafelhalter / Schild**  
**slate sign**  
**caballete de mesa, pizarra**  
**plaque signalétique avec support**



	cm	↑ cm	€
00060 5	12 x 4	7	7,00



**2 Tischaufsteller**  
**2 table stands**  
**2 caballetes de mesa**  
**2 chevalets de table**



	cm	↑ cm	pcs.	€
00017 9	5,5 x 5	3,5	2	3,80
00013 1	5,5 x 5	3,5	2	3,80
00572 3	5,5 x 5	3,5	2	3,80
00573 0	5,5 x 5	3,5	2	3,80

**Tischnummernschild**  
**table numbers**  
**números para mesa**  
**numéros de table**



matt poliert, Zahlen aus schwarzem Siebdruck, Materialstärke 0,8 mm, schwere Qualität, VE: 12 aufeinanderfolgende Zahlen, nicht einzeln lieferbar

satin polished finish, numbers black screenprint, material 0,8 mm thick, heavy gauge, unit: set of 12 numbers only

pulido satinado, números serigrافيados en negro, grosor del acero 0,8 mm serigrafía no apta para lavavajillas, set 12 números seguidos

mat satiné, numéros sérigraphés en noir (non-résistants au lave-vaisselle), épaisseur 0,8 mm, 12 numéros consécutifs

	cm		pcs.	€
71450 2	5,3 x 4,5	1-12	12	18,80
71451 9	5,3 x 4,5	13-24	12	18,80
71452 6	5,3 x 4,5	25-36	12	18,80
71453 3	5,3 x 4,5	37-48	12	18,80
71454 0	5,3 x 4,5	49-60	12	18,80
71455 7	5,3 x 4,5	61-72	12	18,80

HOLZ  
WOOD

**Kartenhalter, 2er Set**  
**table stand, 2 pcs. set**  
**set de 2 piezas, soporte de mesa**  
**set de 2 pièces, support de table**



inklusive 40 weißen Beschriftungskarten  
incl. 40 cards  
incluye 40 tarjetas  
includ 40 étiquettes

	cm	cm		€
00038 4	9 x 3,5	6,5	○	9,00
00039 1	9 x 3,5	6,5	● braun/brown	9,00

**10 Beschriftungsclips, inkl. 10 Schilder**  
**10 sign holders, with 10 signs**  
**10 soportes + 10 cartelitos**  
**10 supports + 10 étiquettes**



	cm	pcs.		€
71482 3	6 x 2,7	10	○	10,50
71483 0	6 x 2,7	10	●	10,50

**Einzelteile / spare parts / piezas sueltas / pièces détachées**

passende Schilder, 10er Set / fitting signs, 10 pcs. set  
set de 10 cartelitos / set de 10 étiquettes

	cm	pcs.		€
11879 9	7,7 x 5,2	10		4,90
12879 8	5,0 x 3,0	10		4,60

**Schilderhalter „FLEXIBEL“**  
**sign holder**  
**soporte para cartelito**  
**support pour menu de table**



**in 2 Längen  
erhältlich**

biegsamer Draht mit zwei Klemmen, extrem flexibel, die Klemmen lassen sich weit öffnen  
bedable metal coil adds visual interest, two metal clip open  
metal cromado flexible, 2 pinzas con gran apertura  
métal chromé, flexible, 2 pinces à grande ouverture

	→ cm		€
71470 0	12	ohne Schilder / without signs sin cartelitos / sans étiquette	3,50
71471 7	23	ohne Schilder / without signs sin cartelitos / sans étiquette	4,20
71480 9	12	inkl. 10 Schilder 11879 / incl. 10 signs 11879 con 10 cartelitos 11879 / avec 10 étiquettes 11879	8,40
71481 6	23	inkl. 10 Schilder 11879 / incl. 10 signs 11879 con 10 cartelitos 11879 / avec 10 étiquettes 11879	9,00

**Einzelteile / spare parts / piezas sueltas / pièces détachées**

passende Schilder, 10er Set / fitting signs, 10 pcs. set  
set de 10 cartelitos / set de 10 étiquettes

	cm	pcs.		€
11879 9	7,7 x 5,2	10		4,90
12879 8	5,0 x 3,0	10		4,60





**Kartenhalter „WAVE“, 4er Set**  
**table stands, 4 pcs. set**  
**soporte de mesa, 4 piezas**  
**set de 4 porte-étiquettes**



inkl. 20 weiße Beschriftungskarten (8,5 x 5,5 cm)  
 incl. 20 white lables (8,5 x 5,5 cm)  
 incluye 20 etiquetas blancas (8,5 x 5,5 cm)  
 20 étiquettes blanches incluses (8,5 x 5,5 cm)

	cm	↑ cm	pcs.	€
00034 6	9,5 x 2,5	2	4	17,60



**Kartenhalter „WÜRFEL“, 4er Set**  
**table stands, 4 pcs. set**  
**soporte de mesa, 4 piezas**  
**set de 4 porte-étiquettes**



inkl. 20 weiße Beschriftungskarten, mehrfach beschriftbar  
 incl. 20 white lables  
 incluye 20 etiquetas blancas  
 20 étiquettes blanches incluses

	cm	pcs.	€
00078 0	3 x 3 x 3	4	10,00



**Kartenhalter „ZYLINDER“, 4er Set**  
**table stands, 4 pcs. set**  
**soporte de mesa, 4 piezas**  
**set de 4 porte-étiquettes**



inkl. 20 weiße Beschriftungskarten, mehrfach beschriftbar  
 incl. 20 white lables  
 incluye 20 etiquetas blancas  
 20 étiquettes blanches incluses

	cm	pcs.	€
00079 7	3 x 3 x 3	4	10,00



**6 Stck. Halter**  
**12 Stck. Karten**

**Kartenhalter-Set**  
**card holder set**  
**set de porta cartelitos**  
**set complet supports + étiquettes**



18-teilig: 6 Kartenhalter 4 x 2,5 cm + 12 Kunststoff-Beschriftungskarten 10 x 5,7 cm  
 18 pcs. set: 6 card holder 4 x 2,5 cm + 12 plastic cards of inscription 10 x 5,7 cm  
 set de 18 piezas: 6 soportes cromados 4 x 2,5 cm + 12 carteles para inscripción, 10 x 5,7 cm  
 set de 18 pièces: 6 supports chromés 4 x 2,5 cm + 12 panneaux 10 x 5,7 cm

	cm	€
00022 3	4 x 2,5	12,00



**Beschriftungskarten, 10er Set**  
**card holder, 10 pcs. set**  
**set de porta cartelitos, 10 piezas**  
**set complet supports + 10 pièces**



	cm	strength	€
00037 7	7,5 x 5	0,4 mm ●	4,90

designed by **KIRCHHOFF & EUWENS**



für DIN A4  
und DIN A5  
Karten



**Tischkartenhalter**  
table stands  
soportes de mesa  
supports de table



	cm	↑ cm	€
00071 1	14 x 5,5	14	14,40

designed by **KIRCHHOFF & EUWENS**



**Tischkartenhalter „PROFI“**  
table stands  
soporte-carta para la mesa  
support pour menu de table



	cm	↑ cm	€
40425 0	9,5 x 7,5	13,5	7,40



**Speisekartenhüllen, 3er Set**  
menu cover, 3 pcs. set  
funda para cartas de menu, set 3 piezas  
protège-menu, le pack de 3



einseitig offen, glasklarer Kunststoff, Lieferung ohne Tischkartenhalter  
open at one side, clear plastic, delivery without table stand  
apertura por un lado, plástico transparente, se entrega sin soporte de sobremesa  
ouverture sur un côté, plastique transparent, livraison sans support de table

	cm	€
00362 0	16,5 x 11,5	6,90
00363 7	20 x 12	8,00



**Tischkartenhalter**  
table stand  
soporte-carta para la mesa  
support pour menu de table



matt poliert  
satin polished finish  
pulido satinado  
poli mat satiné

	cm	↑ cm	€
00030 8	8 x 7	2	2,80
00036 0	6,1 x 4,5	4	1,90



**Kartenhalter, 2er Set**  
**menu holder, 2 pcs. set**  
**porta cartas de mesa, set 2 piezas**  
**set de 2 supports pour menu de table**

HOLZ  
WOOD

	□ cm	↑ cm	pcs.	€
00023 0	8,5 x 6	4,5 / 8,5	2	7,50



**Kartenhalter, 2er Set**  
**menu holder, 2 pcs. set**  
**porta cartas de mesa, set 2 piezas**  
**set de 2 porte-menus de table**

EDELSTAHL  
STAINLESS  
INOX

matt poliert  
satin polished finish  
pulido acabado en mate  
mate

	□ cm	↑ cm	pcs.	€
00021 6	8,5 x 4	4 / 8,5	2	8,80



3 Höhen

**Bankettkartenständer**  
**menu stand / table number**  
**porta-etiqueta o carta de sobremesa con pinza**  
**porte-étiquette de table avec pince, porte-menu, ou n° de table etc.**

EDELSTAHL  
STAINLESS  
INOX

hochglanzpoliert, schwere Qualität  
mirror polished finish, heavy gauge  
acero inoxidable de alta calidad  
inox, belle qualité

	□ cm	↑ cm	€
71460 1	Ø 7,5	18,5	8,00
71461 8	Ø 7,5	29	10,40
71462 5	Ø 7,5	46	11,50



**Kartenhalter, 4er Set**  
**table stands, 4 pcs. set**  
**set 4 piezas soportes de mesa**  
**set de 4 pinces „cubes“**

HOLZ  
WOOD

ACRYL  
ACRYLIC

inkl. 20 weiße Beschriftungskarten  
incl. 20 white labels  
incluye 20 etiquetas blancas  
20 étiquettes blanches incluses

	□ cm	↑ cm	pcs.	€
00074 2	3 x 3	12	4	8,80
00700 0	2,5 x 2,5	12	4	7,30



**Kartenhalter, 2er Set**  
**table stand, 2 pcs. set**  
**set de 2 piezas, soporte de mesa**  
**set de 2 pièces, support de table**

ACRYL  
ACRYLIC

inkl. 40 Beschriftungskarten, durch Magnete einfach zusammenklappbar  
 incl. 40 cards, easily foldable with magnets  
 incluye 40 tarjetas, fácil de plegar, con imanes  
 inclut 40 étiquettes, fácil à plier, avec aimants

	cm	pcs.	€
00076 6	9 x 3 x 5,5	2	16,00



**Tischkartenhalter, 4er Set**  
**table stands, 4 pcs. set**  
**set de 4 pinzas porta-etiquetas inox**  
**pack de 4 porte-étiquettes à pince, inox**

EDELSTAHL  
STAINLESS  
INOX

hochglanzpoliert, schwerer Fuß, inkl. 20 weiße Beschriftungskarten  
 mirror polished finish, heavy food, incl. 20 white labels  
 acabado brillante, incluye 20 etiquetas en blanco  
 poli brillant, inclut 20 étiquettes blanches

	cm	cm	pcs.	€
00070 4	Ø 4	10	4	20,00



**Buffet-Schilder, 3er Set**  
**buffet signs, 3 pcs. set**  
**set de 3 piezas indicadores bufé**  
**set de 3 petits chevalets de buffet**

EDELSTAHL  
STAINLESS  
INOX

können mit einem wasserfesten Filzschreiber beschrieben werden  
 can be marked with water-based felt markers  
 pueden marcarse con rotuladores de agua  
 écriture facile avec un feutre lavable à l'eau

	cm	cm	pcs.	€
03610 9	12 x 6	6	3	15,00
03611 6	16 x 8,5	8,5	3	22,60

**NEW**



**Kreide-Marker, Stärke 2mm, 2er Set**  
**chalk marker, 2 pcs.**  
**rotulador de tiza, 2 pz.**  
**marqueur a la craie liquide, 2 pc.**

Zum Gestalten und Beschriften von Tafeln, Glas und fast allen geschlossenen Oberflächen,  
 deckende Flüssigkreide auf Wasserbasis, feucht abwischbar

For decorating and writing on boards, glass and almost all non-porous surfaces, opaque water-based liquid chalk, wet-wipeable

Rotuladores para pizarra de tiza líquida para decorar y escribir sobre pizarras, cristales y casi todas las superficies no porosas. Tizi líquida opaca al agua que se pueda borrar con un trapo

Pour décorations et inscriptions sur tableaux, verre et presque toutes les surfaces non poreuses, craie liquide opaque à base d'eau, effaçable avec un chiffon humide

	cm	cm	pcs.	€	
71490 8	Ø 1	13	white	2	5,40
71491 5	Ø 1	13	black	2	5,40



**Aufsteller „ACHTUNG RUTSCHGEFAHR“  
stand  
letrero  
panneau**



	cm	cm	€
71421 2	30 x 63	63	6,60

klappbar / folding



**Türsymbol  
sign plate  
pictogramas  
pictogrammes**



matt poliert, Materialstärke 1 mm, schwarzer Siebdruck, Rückseite selbstklebend  
satin polished finish, back side auto-adhesive

acabado satinado, grosor 1 mm, serigrafía negra, reverso adhesivo  
mat satiné, épaisseur 1 mm, sérigraphie couleur noire, dos adhésif



	cm		€
71401 4	Ø 7,5	Damen / ladies / damas / dames	1,80
71402 1	Ø 7,5	Herren / gents / caballeros / messieurs	1,80
71403 8	Ø 7,5	Damen und Herren / ladies und gents damas y caballeros / dames et messieurs	1,80
71404 5	Ø 7,5	Rollstuhl / disabled / discapacitados / handicapés	1,80
71405 2	Ø 7,5	WC	1,80
71406 9	Ø 7,5	Rauchen / smoking / fumadores / fumeurs	1,80
71407 6	Ø 7,5	Nicht rauchen / no smoking no fumadores / non-fumeurs	1,80
71408 3	Ø 7,5	Bitte hinsetzen / please sit por favor siéntese / asseyez-vous SVP	1,80
71409 0	Ø 7,5	Garderobe / coats / guardarropa / vestiaire	1,80
71410 6	Ø 7,5	Handy verboten / no mobiles apague el móvil / portables éteints	1,80
71411 3	Ø 7,5	„ZIEHEN“	1,80
71412 0	Ø 7,5	„DRÜCKEN“	1,80
71413 7	Ø 7,5	„PULL“	1,80
71414 4	Ø 7,5	„PUSH“	1,80
71415 1	Ø 7,5	„KEIN ZUTRITT“	1,80
71416 8	Ø 7,5	„NO ENTRY“	1,80
71419 9	Ø 16	Nicht rauchen / no smoking no fumadores / non-fumeurs	6,40



71419

EAN = 40 04 133 XXXXX X



**Vase  
flower vase  
florero  
vase soliflor**



hochglanzpoliert, schwerer Fuß, möbelschonende Unterseite  
mirror polished finish, heavy quality  
pulido brillante, alta calidad  
brillant, bonne qualité

	☐ cm	↑ cm	📦 kg	€
04018 2	Ø 6	19	0,23	22,00



**Vase  
flower vase  
florero  
vase soliflor**



Edelstahl-Look, Zinkdruckguss, vernickelt, lackiert, anlaufgeschützt, schwere Ausführung  
stainless steel look, heavy zink alloy, nickel plated, laquered  
aspecto acero, acabado satinado, alta calidad  
aspect inox, fini mat satiné, bonne qualité

	☐ cm	↑ cm	📦 kg	€
04017 5	Ø 6,5	18	0,36	14,50



**Vase  
flower vase  
florero  
vase soliflor**



Edelstahl-Look, Zinkdruckguss, vernickelt, lackiert, anlaufgeschützt, schwere Ausführung  
stainless steel look, heavy zink alloy, nickel plated, laquered  
aspecto acero, acabado satinado, alta calidad  
aspect inox, fini mat satiné, bonne qualité

	☐ cm	↑ cm	📦 kg	€
04015 1	Ø 4	16,5	0,17	12,60
04016 8	Ø 4,5	20	0,20	14,00

designed by **KIRCHHOFF & EUWENS**



**2-teilig**

**Vase  
flower vase  
florero  
soliflor**



inkl. Halterung, Blume fixiert sich durch die Halterung mittig in der Vase  
incl. holder, the holder fixes a flower in the middle of the vase  
incluido fijación que mantiene la flor en el centro del jarrón  
y compris fixation pour centrer la fleur

	☐ cm	↑ cm	📦 kg	€
04019 9	Ø 5	13	0,29	8,80



**Kerzenleuchter, 2er Set**  
**candle holder, 2 pcs. set**  
**candelabros, set de 2 piezas**  
**set de 2 chandeliers**

METALL  
VERSILBERT

ohne Kerzen, möbelschonende Unterseite  
 without candles, with non-scratching undersurface  
 sin velas, con base antiralladuras  
 livré sans bougies, avec base revêtue antirayures

	□ cm	↑ cm	pcs.	€
04008 3	Ø 6	7	2	9,90



**Kerzenleuchter „CLASSIC“, 2er Set**  
**candle holder, 2 pcs. set**  
**candelabros, set de 2 piezas**  
**set de 2 chandeliers**

METALL  
VERSILBERT

ohne Kerzen, möbelschonende Unterseite  
 without candles, with non-scratching undersurface  
 sin velas, con base antiralladuras  
 livré sans bougies, avec base revêtue antirayures

	□ cm	↑ cm	pcs.	€
04035 9	Ø 10	20,5	2	22,00



**Kerzenleuchter „CLASSIC“**  
**candle holder**  
**candelabro**  
**chandelier**

METALL  
VERSILBERT

3-flammig, ohne Kerzen, möbelschonende Unterseite  
 3-lid, without candles, with non-scratching undersurface  
 3 ramas, se sirve sin velas, con base antiralladuras  
 3 branches, livré sans bougies, avec base revêtue antirayures

	□ cm	↑ cm	€
04036 6	22 x 10	22,5	22,00



**Kerzenleuchter „CLASSIC“**  
**candle holder**  
**candelabros**  
**chandelier**

METALL  
VERSILBERT

5-flammig, ohne Kerzen, möbelschonende Unterseite  
 5-lids, without candles, with non-scratching undersurface  
 para 5 velas, se sirve sin velas, con base antiralladuras  
 5 branches, livré sans les bougies, avec base revêtue antirayures

	□ cm	↑ cm	€
04037 3	22 x 22	24	27,50



**Kerzenleuchter**  
candle holder  
candelabro  
chandelier



04001

hochwertige Gastro Ausführung, ohne Kerzen, möbelschonende Unterseite  
heavy quality, without candles, with non-scratching undersurface  
alta calidad (se entrega sin velas), con base antirralladuras  
haute qualité (livraison sans bougies), avec base revêtue antirayures

	☐ cm	↑ cm		€
04001 4	27,5 x 27,5	25	5-flammig / 5 lid / 5 ramas / 5 branches	42,00
04002 1	27,5 x 11	25	3-flammig / 3 lid / 3 ramas / 3 branches	31,50
04003 8	Ø 11	22	1-flammig / 1 lid / 1 rama / 1 branche	20,00
04004 5	Ø 11	10	1-flammig / 1 lid / 1 rama / 1 branche	13,00



04002



04003



04004



**Kerzenleuchter „XL“**  
candle holder  
candelabro  
grand chandelier



04005

extra hoch und schwer, ohne Kerzen, möbelschonende Unterseite  
extra high and heavy, without candles, with non-scratching undersurface  
pesado y de alta calidad, se entrega sin velas, con base antirralladuras  
lourd et de haute qualité, livraison sans bougies, avec base revêtue antirayures

	☐ cm	↑ cm		€
04005 2	35 x 13	39	3-flammig / 3 lid / 3 ramas / 3 branches	51,00
04006 9	35 x 35	39	5-flammig / 5 lid / 5 ramas / 5 branches	64,00



04006

Höhe 39 cm





### Kerzenleuchter candle holder candelabro chandelier



extra schwerer Fuß, Kupfer-look, möbelschonende Unterseite  
heavy foot, copper look, with table gentler bottom, with non-scratching undersurface  
pie pesado, cobre en color, con mesa de fondo suave, con base antirralladuras  
ped lourd, couleur cuivre, avec table de fond doux, avec base revêtue antirayures

	☐ cm	↑ cm		€
04024 3	Ø 10	11	● copper	14,00
04025 0	Ø 10	16	● copper	16,00
04026 7	Ø 10	22	● copper	18,00



### Kerzenleuchter candle holder candelabro chandelier



extra schwerer Fuß, verchromt, möbelschonende Unterseite  
heavy foot, chrome plated, with non-scratching undersurface  
pie pesado, asa cromado, con base antirralladuras  
ped lourd, chromé, avec base revêtue antirayures

	☐ cm	↑ cm		€
04020 5	Ø 10	11	● chrome	12,00
04021 2	Ø 10	16	● chrome	14,00
04022 9	Ø 10	22	● chrome	16,00

### Kerzenleuchter „XXL“ candle holder candelabro chandelier



5-flammig, Zinkdruckguss, vernickelt, schwere Ausführung, einfache Montage, ohne Kerzen  
5 branches, zinc alloy nickel-plated, heavy model, easy to assemble  
5 ramas, fundición de aleación de zinc niquelada, alta calidad y fácil montaje  
5 branches, fonte d'alliage de zinc nickelée, haute qualité, facile à monter

	☐ cm	↑ cm	€
04000 7	46 x 46	56	104,00
04012 0	46 x 46	78	176,00
04013 7	46 x 46	98	229,00

3 Höhen:  
56 cm  
78 cm  
98 cm

EAN = 40 04 133 XXXX X



**Windlicht „BALL“**  
**wind light**  
**porta vela**  
**lampe à bougie**

GLAS  
GLASS

EDELSTAHL  
STAINLESS  
INOX

Edelstahl poliert, Glas satiniert, schwere standsichere Ausführung, möbelschonende Unterseite  
 mirror polished finish, heavy quality, with non-scratching undersurface  
 acabado efecto espejo, alta calidad, base pesada, con base antirralladuras  
 poli brillant, belle qualité, pied pesant, avec base revêtue antirayures

	☐ cm	↑ cm	€
03033 6	Ø 12	11,5	17,00



**Windlicht / Tischleuchte**  
**wind light**  
**porta velas**  
**porte-bougie de table, anti-vent**

GLAS  
GLASS

METALL  
VERCHROMT

möbelschonende Unterseite  
 with non-scratching undersurface  
 con base antirralladuras  
 avec base revêtue antirayures

	☐ cm	↑ cm	€
03013 8	Ø 11	22	20,00
03014 5	Ø 11	32	23,00

**Einzelteile / spare parts / piezas sueltas / pièces détachées**

Ersatzglas / spare glass / vidrio de recambio solo / verre de rechange transparent, seul

03015 2			7,20
---------	--	--	------

**Edelstahlfuß wird nicht heiß!**  
**Keine Verbrennungsgefahr!**



**Windlichter, 2er Set**  
**wind lights, 2 pcs. set**  
**set de 2 piezas porta velas**  
**set de 2 porte-bougies anti-vent**

GLAS  
GLASS

EDELSTAHL  
STAINLESS  
INOX

hochglanzpoliert, Gläser klar, möbelschonende Unterseite  
 mirror polished finish, glasses clear, with non-scratching undersurface  
 acabado pulido brillante, vidrio transparente, con base antirralladuras  
 brillant, verre transparent, avec base revêtue antirayures

	☐ cm	↑ cm	pcs.	€
03026 8	Ø 5	8	2	12,00

**Edelstahlfuß wird nicht heiß!**  
**Keine Verbrennungsgefahr!**

**Einzelteile / spare parts / piezas sueltas / pièces détachées**

Ersatzglas / spare glass / vidrio de recambio solo / verre de rechange transparent, seul

03027 5				1,40
---------	--	--	--	------



03016  
2er Set / 2 pcs. set

**Windlichter, 2er Set**  
**wind lights, 2 pcs. set**  
**set de 2 portavelas antiviento**  
**set de 2 porte-bougies anti-vent**



2er Set, matt poliert, Gläser satiniert, Edelstahlfuß wird nicht heiß, keine Verbrennungsgefahr, möbelschonende Unterseite

2 pcs. set, satin polished finish, glasses satin, with non-scratching undersurface

set de dos piezas, acabado pulido mate satinado, cristales satinados, con base antirralladuras

set de 2, inox mat satiné et verre mat, avec base revêtue antirayures

	☐ cm	↑ cm	pcs.	€
03016 9	Ø 7,5	12,5	2	22,00

**Einzelteile / spare parts / piezas sueltas / pièces détachées**

Ersatzglas / spare glass / cristal de recambio / verre de rechange

03028 2	für / for / para / pour 03016			1,40
---------	-------------------------------	--	--	------



**Edelstahlfuß wird nicht heiß!**  
**Keine Verbrennungsgefahr!**

**Windlichter, 2er Set**  
**wind lights, 2 pcs. set**  
**set de 2 portavelas antiviento**  
**set de 2 porte-bougies anti-vent**



matt poliert, Gläser satiniert, möbelschonende Unterseite

satin polished finish, glasses satin, with non-scratching undersurface

pulido acabado efecto satinado, cristales satinados, con base antirralladuras

inox mat satiné et verre mat, avec base revêtue antirayures

	☐ cm	↑ cm	pcs.	€
03020 6	Ø 5	15	2	15,40

**Einzelteile / spare parts / piezas sueltas / pièces détachées**

Ersatzglas / spare glass / cristal de recambio / verre de rechange

03025 1				1,40
---------	--	--	--	------



**Edelstahlfuß wird nicht heiß!**  
**Keine Verbrennungsgefahr!**

**Windlichter, 2er Set**  
**wind lights, 2 pcs. set**  
**portavelas antiviento, set de 2 piezas**  
**set de 2 porte-bougies anti-vent**



matt poliert, Gläser satiniert, möbelschonende Unterseite

satin polished finish, glasses satin, with non-scratching undersurface

pulido acabado satinado, vidrio satinado, con base antirralladuras

poli mat satiné, verre mat satiné, avec base revêtue antirayures

	☐ cm	↑ cm	pcs.	€
03012 1	Ø 8	22	2	18,50

**NEW**



03038  
2er Set / 2 pcs. set



03039  
einzel / single



03038  
2er Set / 2 pcs. set



03039  
einzel / single

**Windlichter „ELEMENT“  
wind lights  
antiviento portavelas  
porte-bougie anti-vent**



Beton, Gläser klar, inklusive Teelichter, mit möbelschonender Unterseite  
concrete, glasses clear, including tea lights  
hormigón, vidrio transparente, velas incluido  
bèton, verre transparent, bougies inclus

	☐ cm	↑ cm		€
03038 1	Ø 6	8	2er Set / 2 pcs. set	12,00
03039 8	Ø 7,5	13	einzel / single	9,00

**Einzelteile / spare parts / piezas sueltas / pièces détachées**

Ersatzglas / spare glass / vidrio de recambio solo / verre de rechange transparent, seul

	☐ cm	↑ cm		€
03098 5	Ø 6	5	passend zu 03038 / suitable for 03038 apto para 03038 / pour tous 03038	2,80
03099 2	Ø 7,5	9	passend zu 03039 / suitable for 03039 apto para 03039 / pour tous 03039	3,50

**Abbildungen in  
Originalgröße**



# PROFI LINE



Profi-Material auf der Basis von Polypropylen, das optisch und haptisch einem Naturprodukt nahezu gleich ist. Matte Oberfläche, handgefertigt.

Wickerware made of synthetic fiber. Matt surface looks like real nature rattan, handmade.

Trensado a mano en fibra sintética de polipropileno, su acabado mate le da el aspecto de un producto natural.

Tressé main en fibre synthétique polypropylène, sa finition mate lui donne un aspect totalement naturel.





50210  
Ø 37 cm

**Korb, rund „PROFI LINE“**  
basket, round  
cesta redonda  
corbeille ronde



	□ cm	↑ cm	€
50210 9	Ø 37	9	15,40
50215 4	Ø 42	12	21,00



50215  
Ø 42 cm



**Korb, rund „PROFI LINE“**  
basket, round  
cesta redonda  
corbeille ronde



	□ cm	↑ cm	€
50205 5	Ø 31 / 37	12 / 6	19,80



50100

**Korbschütte, rund „PROFI LINE“**  
basket, round  
cesta redonda  
corbeille ronde



mit Griffen  
with handles  
con asas  
avec anses

	□ cm	↑ cm	€
50100 3	Ø 36,5	12,0	26,50
50105 8	Ø 42,0	18,5	28,50
50110 2	Ø 46,0	18,5	36,40



50110

50300



**Systemkorb, gestäbt „PROFI LINE“**  
 basket  
 cesta  
 corbeille



	□ cm	↑ cm	€
50300 7	30 x 40	27 / 16	59,00
50305 2	45 x 40	27 / 16	64,00
50310 6	60 x 40	27 / 16	69,00

50305



50310



**Trenner „PROFI LINE“**  
 divider  
 divisor  
 paroi de séparation



	→ cm	↑ cm	€
50315 1	38	26 / 15	10,00



**Systemkorb „PROFI LINE“**  
 basket  
 cesta  
 corbeille



	□ cm	↑ cm	€
50400 4	40 x 50	25 / 14	49,90



**Brötchenschütte „PROFI LINE“**  
 roll / bun basket  
 cesta para bollos  
 corbeille à petits pains



	□ cm	↑ cm	€
50510 0	60 x 40	60	122,00







50500



50501

**Stangenbrotkorb „PROFI LINE“**  
 baguette basket  
 cesta de baguette  
 corbeille à baguettes



	□ cm	↑ cm		€
50500 1	Ø 28 / 30	38	●	41,00
50501 8	Ø 28 / 30	38	●	41,00

**Bäcker-Maß-Größen**



50910  
60 x 20 cm



50915  
60 x 40 cm

**Korb Bäcker-Maß „PROFI LINE“**  
 basket baker size  
 cesta tamaño panaderia  
 corbeille à pâtisserie dimensions „boul-pâte“



	□ cm	↑ cm		€
50900 9	40 x 20	5		16,50
50905 4	40 x 30	5		19,00
50910 8	60 x 20	5		20,60
50915 3	60 x 40	5		30,00



**Auslage Tablett flach, Bäcker-Maß**  
 "PROFI LINE"  
 display tray flat, baker size  
 bandeja de presentación, tamaño panaderia  
 plateau de présentation, dimensions „boul-pâte“



	□ cm	↑ cm		€
40296 6	40 x 30	1		13,50
40297 3	60 x 40	1		24,00



**NEW**

hellbeige / light beige  
beis claro / beige clair



beige / beige  
beis / beige



braun / brown  
marrón / marron



schwarz / black  
negro / noir



50800



50801



50803



50802



50818

**Korb, oval „PROFI LINE“**  
basket, oval  
cesta oval  
corbeille ovale



	□ cm	↑ cm		€
50800 2	25 x 19	6,5		7,80
50801 9	25 x 19	6,5		7,80
<b>NEW</b> 50803 3	25 x 19	6,5		7,80
50802 6	25 x 19	6,5		7,80
50815 6	32 x 23	7,0		10,00
50816 3	32 x 23	7,0		10,00
<b>NEW</b> 50818 7	32 x 23	7,0		10,00
50817 0	32 x 23	7,0		10,00



50600



50607



50611

**Korb, rund „PROFI LINE“**  
basket, round  
cesta redonda  
corbeille ronde



	□ cm	↑ cm		€
50600 8	Ø 16	8		6,60
50601 5	Ø 16	8		6,60
<b>NEW</b> 50603 9	Ø 16	8		6,60
50602 2	Ø 16	8		6,60
50605 3	Ø 20	8		8,70
50606 0	Ø 20	8		8,70
<b>NEW</b> 50608 4	Ø 20	8		8,70
50607 7	Ø 20	8		8,70
50610 7	Ø 29	7		10,90
50611 4	Ø 29	7		10,90
<b>NEW</b> 50613 8	Ø 29	7		10,90
50612 1	Ø 29	7		10,90

**Baguette Korb, oval „PROFI LINE“**  
 baguette basket, oval  
 cesta de baguette, oval  
 corbeille à baguettes, ovale



	□ cm	↑ cm		€
50805 7	28 x 16	8	●	8,70
50806 4	28 x 16	8	●	8,70
<b>NEW</b> 50808 8	28 x 16	8	●	8,70
50807 1	28 x 16	8	●	8,70
50820 0	40 x 16	8	●	11,60
50821 7	40 x 16	8	●	11,60
<b>NEW</b> 50823 1	40 x 16	8	●	11,60
50822 4	40 x 16	8	●	11,60



**Korb, rechteckig „PROFI LINE“**  
 basket, rectangular  
 cesta rectangular  
 corbeille rectangulaire



	□ cm	↑ cm		€
50700 5	26,5 x 19,0	7	●	9,20
50701 2	26,5 x 19,0	7	●	9,20
<b>NEW</b> 50703 6	26,5 x 19,0	7	●	9,20
50702 9	26,5 x 19,0	7	●	9,20
50705 0	31,0 x 21,0	9	●	10,40
50706 7	31,0 x 21,0	9	●	10,40
<b>NEW</b> 50708 1	31,0 x 21,0	9	●	10,40
50707 4	31,0 x 21,0	9	●	10,40



**NEW**

hellbeige / light beige  
beis claro / beige clair



beige / beige  
beis / beige



braun / brown  
marrón / marron



schwarz / black  
negro / noir



**NEW**



**GN-Maß  
GN-size**

**GN 1/1 Korb „PROFI LINE“**  
**GN 1/1 basket**  
**cesta 1/1 GN**  
**corbeille 1/1 GN**



stabile Ausführung, mit Edelstahldraht im Rand zur Stabilisierung  
very solid, with stainless steel wire frame to stabilize the basket  
muy resistente, con refuerzo de alambre inox  
très résistante, avec son fil de renfort inox

	□ cm	↑ cm		€
50720 3	53 x 32,5	10		24,00
50721 0	53 x 32,5	10		24,00
50723 4	53 x 32,5	10		24,00
50722 7	53 x 32,5	10		24,00



50710

**Korb, rechteckig „PROFI LINE“**  
**basket, rectangular**  
**cesta rectangular**  
**corbeille rectangulaire**



	□ cm	↑ cm		€
50710 4	40 x 30	10		19,80
50711 1	40 x 30	10		19,80
<b>NEW</b> 50713 5	40 x 30	10		19,80
50712 8	40 x 30	10		19,80



50711



50713



50712

**NEW**



50624

**Korb, oval „PROFI LINE“**  
basket, oval  
cesta, oval  
corbeille, ovale



	cm	↑ cm		€
50624 4	19 x 12	6	●	4,20
50625 1	19 x 12	6	●	4,20
50627 5	19 x 12	6	●	4,20
50626 8	19 x 12	6	●	4,20

**NEW**

50635



50629

**Korb, rechteckig „PROFI LINE“**  
basket, rectangular  
cesta rectangular  
corbeille rectangulaire



	cm	↑ cm		€
50632 9	17 x 11	9	●	4,00
50633 6	17 x 11	9	●	4,00
50635 0	17 x 11	9	●	4,00
50634 3	17 x 11	9	●	4,00
50628 2	19 x 13	6	●	4,20
50629 9	19 x 13	6	●	4,20
50631 2	19 x 13	6	●	4,20
50630 5	19 x 13	6	●	4,20

**NEW**



50620



50621



50622



50623

**Korb, rund „PROFI LINE“**  
basket, round  
cesta, redonda  
corbeille, ronde



	cm	↑ cm		€
50620 6	Ø 13	10	●	4,20
50621 3	Ø 13	10	●	4,20
50623 7	Ø 13	10	●	4,20
50622 0	Ø 13	10	●	4,20

# GN LINE

GASTRONORM-SYSTEM

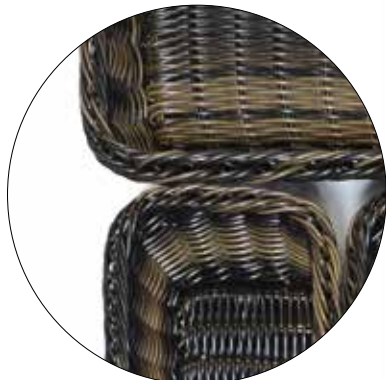

2 Höhen - 6,5 und 10 cm  
2 heights - 6,5 and 10 cm



40293  
GN1/1 - 10 cm



40225  
GN1/4 - 6,5 cm  
40292  
GN1/2 - 10 cm

Korb „GN LINE“  
basket GN  
cesta GN  
corbeille GN



stabile Ausführung mit Edelstahldraht im Rand zur Stabilisierung  
very solid with stainless steel wire frame to stabilize the basket  
muy resistente con refuerzo de alambre inox  
très résistante avec son fil de renfort inox

	cm	↑ cm	GN		€
40291 1	53,0 x 32,5	6,5	1/1	●	18,50
40290 4	32,5 x 26,5	6,5	1/2	●	11,50
40223 2	32,5 x 17,5	6,5	1/3	●	9,20
40225 6	26,5 x 16,2	6,5	1/4	●	7,00
40227 0	17,6 x 16,2	6,5	1/6	●	4,70
40229 4	32,5 x 35,4	6,5	2/3	●	13,80
40293 5	53,0 x 32,5	10,0	1/1	●	23,00
40292 8	32,5 x 26,5	10,0	1/2	●	13,80
40243 0	32,5 x 17,5	10,0	1/3	●	11,00
40245 4	26,5 x 16,2	10,0	1/4	●	8,20
40247 8	17,6 x 16,2	10,0	1/6	●	7,00
40249 2	32,5 x 35,4	10,0	2/3	●	17,20



GN1/1

Besteckbehälter GN1/1  
dispenser GN1/1  
dispensador de cubiertos GN1/1  
bac à couverts GN1/1



in Handarbeit geflochten, 4 Mulden, Kunststoff-Geflecht, Drahtgestell, braun-schwarz  
wickerwork, 4 compartments, with reinforced chromed wire structure, brown-black  
cesta trensada a mano, 4 compartimentos, de plástico, con bastidor cromado reforzado, marrón oscuro  
corbeille tressée à main, 4 compartiments, en plastique, cadre acier chromé renforcé, couleur marron foncé

	cm	↑ cm	GN		€
11966 6	53 x 32,5	9	1/1	●	33,00

# GN LINE

GASTRONORM-SYSTEM

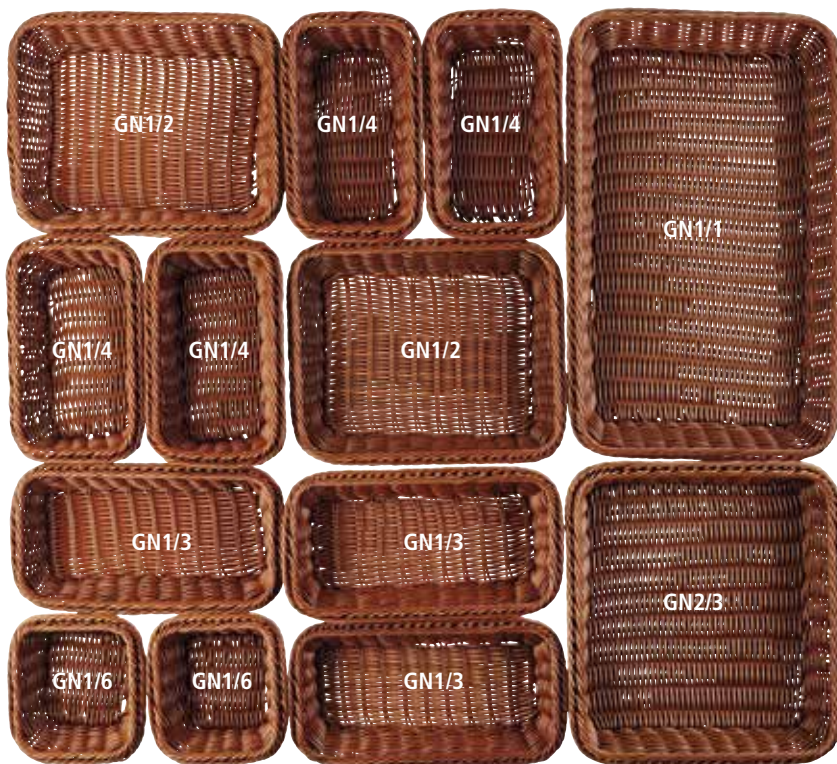
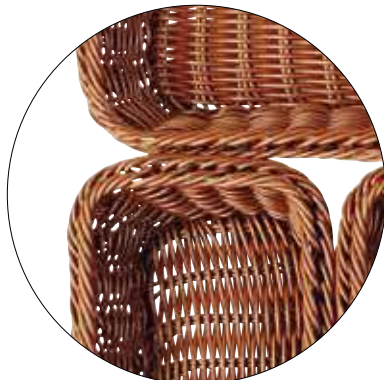

40228  
GN1/6

2 Höhen - 6,5 und 10 cm  
2 heights - 6,5 and 10 cm



40222  
GN1/2



40220  
GN1/1



40264  
GN1/4

40272  
GN1/2



40272  
GN1/2

Korb „GN LINE“  
basket GN  
cesta GN  
corbeille GN



stabile Ausführung mit Edelstahldraht im Rand zur Stabilisierung  
very solid with stainless steel wire frame to stabilize the basket  
muy resistente con refuerzo de alambre inox  
très résistante avec son fil de renfort inox

	cm	cm	GN		€
40220 1	53 x 32,5	6,5	1/1	●	17,20
40222 5	32,5 x 26,5	6,5	1/2	●	10,00
40224 9	32,5 x 17,6	6,5	1/3	●	8,40
40226 3	26,5 x 16,2	6,5	1/4	●	6,50
40228 7	17,6 x 16,2	6,5	1/6	●	4,40
40230 0	32,5 x 35,4	6,5	2/3	●	13,20
40240 9	53 x 32,5	10	1/1	●	21,90
40242 3	32,5 x 26,5	10	1/2	●	13,40
40244 7	32,5 x 17,6	10	1/3	●	10,00
40246 1	26,5 x 16,2	10	1/4	●	7,20
40248 5	17,6 x 16,2	10	1/6	●	5,90
40250 8	32,5 x 35,4	10	2/3	●	16,00
40260 7	53 x 32,5	6,5	1/1	●	17,20
40262 1	32,5 x 26,5	6,5	1/2	●	10,40
40263 8	32,5 x 17,6	6,5	1/3	●	8,40
40264 5	26,5 x 16,2	6,5	1/4	●	6,50
40266 9	17,6 x 16,2	6,5	1/6	●	4,40
40268 3	32,5 x 35,4	6,5	2/3	●	13,20
40270 6	53 x 32,5	10	1/1	●	21,90
40272 0	32,5 x 26,5	10	1/2	●	13,40
40274 4	32,5 x 17,6	10	1/3	●	10,00
40276 8	26,5 x 16,2	10	1/4	●	7,20
40278 2	17,6 x 16,2	10	1/6	●	5,90
40280 5	32,5 x 35,4	10	2/3	●	16,00



rund

**Tisch- und Buffetkorb, rund „ECONOMIC“**  
**buffet basket, round**  
**cesta de bufé redonda**  
**corbeille de buffet ronde**



	☐ cm	↑ cm		€
40132 7	Ø 19,0	9,5	●	3,60
40135 8	Ø 25,5	8,5	●	4,90
40144 0	Ø 39,0	10,0	●	13,80
40191 4	Ø 19,0	9,5	●	3,60
40192 1	Ø 25,5	8,5	●	4,90



oval

**Tisch- und Buffetkorb, oval „ECONOMIC“**  
**buffet basket, oval**  
**cesta de bufé oval**  
**corbeille de buffet ovale**



	☐ cm	↑ cm		€
40137 2	23,0 x 17,0	8,0	●	4,00
40139 6	28,5 x 17,0	8,5	●	5,20
40146 4	37,0 x 27,5	9,0	●	9,90
40193 8	23,0 x 17,0	8,0	●	4,00
40194 5	28,5 x 17,0	8,5	●	5,20



rechteckig

**Tisch- und Buffetkorb, eckig „ECONOMIC“**  
**buffet basket rectangular**  
**cesta de bufé rectangular**  
**corbeille de buffet rectangulaire**



	☐ cm	↑ cm		€
40140 2	23,0 x 17,0	8	●	4,00
40159 4	31,5 x 22,0	8,5	●	6,00
40195 2	23,0 x 17,0	8	●	4,00
40196 9	31,5 x 22,0	8,5	●	6,00



**Buffet-Korb GN "ECONOMIC"**  
**GN basket**  
**cesta GN**  
**corbeille GN**



	☐ cm	↑ cm	GN	€
40152 5	32,5 x 26,5	8	1/2	8,90
40148 8	53,0 x 32,5	8	1/1	24,00



**Buffet- und Auslagekorb "ECONOMIC"**  
**buffet basket**  
**cesta de bufé**  
**corbeille de buffet**



stabile Ausführung mit Edelstahldraht im Rand zur Stabilisierung  
 very solid with stainless steel wire frame to stabilize the basket  
 muy resistente con refuerzo de alambre inox  
 très résistante avec son fil de renfort inox

	☐ cm	↑ cm	€
40161 7	50,0 x 25,0	6	14,00
40160 0	50,0 x 20,0	6	12,80



Ergänzung:  
11027  
Kuppelhaube



40129  
Buffet-Korb

**Buffet-Korb "ECONOMIC"**  
buffet basket  
cesta de bufé  
corbeille de buffet



stabile Ausführung mit Edelstahldraht im Rand zur Stabilisierung  
very solid with stainless steel wire frame to stabilize the basket  
muy resistente con refuerzo de alambre inox  
très résistante avec son fil de renfort inox

	□ cm	↑ cm	GN	€
40129 7	53 x 32,5	15,5	1/1	26,00

**Einzelteile / spare parts / piezas sueltas / pièces détachées**

GN Kuppelhaube / GN cover / GN cúpula / GN cloche bombée

11027 4	54 x 33	20		49,00
---------	---------	----	--	-------



**Buffet-Korb „ECONOMIC“**  
buffet basket  
cesta de bufé  
corbeille de buffet



stabile Ausführung mit Edelstahldraht im Rand zur Stabilisierung  
very solid with stainless steel wire frame to stabilize the basket  
muy resistente con refuerzo de alambre inox  
très résistante avec son fil de renfort inox

	□ cm	↑ cm	€
40153 2	45 x 42	17 / 24	25,00



40149

**Buffet-Korb, rund „ECONOMIC“**  
buffet basket, round  
cesta de bufé redonda  
corbeille de buffet ronde



stabile Ausführung mit Edelstahldraht im Rand zur Stabilisierung  
very solid with stainless steel wire frame to stabilize the basket  
muy resistente con refuerzo de alambre inox  
très résistante avec son fil de renfort inox

	□ cm	↑ cm	€
40149 5	∅ 40	12,5	18,40

**Einzelteile / spare parts / piezas sueltas / pièces détachées**

Rolltop-Haube / rolltop cover / campana abatible / cloche basculante

18388 9	∅ 38	20	mit verchromtem Kugelgriff with chrome plated handle con pomo cromado avec bouton chromé	19,40
18387 2	∅ 38	20	mit vergoldetem Kugelgriff gold plated handle pomo dorado bouton doré	19,40



18388



**Buffet-Korb "ECONOMIC"**  
**buffet basket**  
**cesta de bufé**  
**corbeille buffet**



in Handarbeit geflochten, stabile Ausführung, Edelstahl Fixierungsrahmen, zur Rutschsicherung, ohne Haube

wickerwork, stainless steel fix the cover, without cover

cesta trensada a mano, con marco cromado patentado para fijar y encajar la campana (se entrega sin la campana)

corbeille tressée main, cadre fil acier inoxydable pour fixer la cloche (livré sans la cloche)



40148

	□ cm	↑ cm	GN	€
40150 1	56,5 x 36	10		30,00

Buffet-Korb mit Fixierahmen / basket with frame to fix  
 cesta con marco de fijación / corbeille avec cadre de fixation

40148 8	53,0 x 32,5	8	1/1	24,00
---------	-------------	---	-----	-------

Buffet-Korb ohne Fixierahmen / basket without frame to fix  
 cesta borde reforzada (sin fijación campana) / corbeille bord renforcé (sans cadre de fixation cloche)

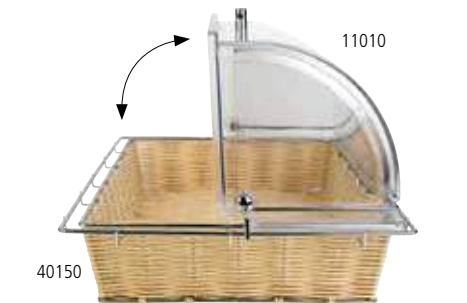

11010

**Rolltop-Haube GN1/1**  
**rolltop cover**  
**campana rolltop**  
**cloche rolltop**



patentiert, passend für GN-Behälter, -Tablets, etc., leichtgängig auf- und zuklappbar 90°, temperaturbeständig -30°C bis ca. 120°C

patented, suitable for GN trays, solid quality, 90° opening, heat-resistant -30°C to 120°C

patentada, para bandejas GN, apertura 90°, temperatura -30°C a +120°C

brevetée, pour plateaux GN, ouverture 90°, température -30°C à +120°C

40150



11010

	□ cm	↑ cm	GN	€
11008 3	53,0 x 32,5	19	1/1	59,90

vergoldeter Griff / gold plated handle  
 pomo dorado / bouton doré

11010 6	53,0 x 32,5	19	1/1	59,90
---------	-------------	----	-----	-------

verchromter Griff / chrome plated handle  
 pomo cromado / bouton chromé

designed by **CULTURE FORM**



11021  
GN1/2



11026  
GN1/1



11027



11028

**GN Kuppelhaube**  
**GN cover**  
**GN cúpula**  
**GN cloche bombée**



glasklarer Kunststoff, Griff verchromt

clear, chrome knob

transparente, asa cromada

transparente, anse chromée

	□ cm	↑ cm		€
11021 2	33 x 28	17	geschlossen / totally closed cerrada / tolement fermée	22,00

11022 9	33 x 28	17	mit Front-Ausschnitt / one long side cut out gran apertura frontal / grande ouverture frontale	24,00
---------	---------	----	---	-------

11026 7	54 x 33	20	geschlossen / totally closed cerrada / tolement fermée	47,00
---------	---------	----	---	-------

11027 4	54 x 33	20	mit Front-Ausschnitt / one long side cut out gran apertura frontal / grande ouverture frontale	49,00
---------	---------	----	---	-------

11028 1	54 x 33	20	mit seitlichem Ausschnitt / one small side cut out pequeña apertura lateral / petite ouverture latérale	49,00
---------	---------	----	--	-------



33221

**Buffet-Gestell für Körbe**  
**buffet stand for baskets**  
**expositor para cestas**  
**support métal pour corbeilles**



2-stufig, für 2 rechteckige Körbe, platzsparend zusammenklappbar, Lieferung ohne Körbe  
 2-tier, for 2 rectangular baskets, can be folded, place saving, delivery without baskets  
 2 alturas, para 2 cestas rectangulares, totalmente plegable para ahorrar espacio, se entrega sin cestas  
 2 hauteurs, pour 2 corbeilles rectangulaires, pliable pour son rangement, livré sans corbeilles



40222



40262



	□ cm	↑ cm	€
33221 8	46 x 24	18 - 21	39,00

**Einzelteile / spare parts / piezas sueltas / pièces détachées**

Tisch- und Buffet-Korb rechteckig „BASIC“ / buffet basket / cesta de bufé / corbeille de buffet

30286 0	30,0 x 22,0	7	●	3,60
30288 4	41,0 x 29,0	7	●	7,00
40154 9	30,0 x 24,5	8	●	9,00
40159 4	31,5 x 22,0	8,5	●	6,00
40161 7	50,0 x 25,0	6	●	14,00
40222 5	32,5 x 26,5	6,5	●	10,00
40242 3	32,5 x 26,5	10	●	13,40
40262 1	32,5 x 26,5	6,5	●	10,40
40272 0	32,5 x 26,5	10	●	13,40



2 Größen:  
 GN1/2  
 GN1/1

**Buffet-Gestell „DOPPELDECKER“**  
**buffet frame**  
**estructura para bufé**  
**support buffet**



für GN, 2-teilig, einfach zusammensetzbar, Etagen-Abstand ca. 26 cm, platzsparend, stabile Ausführung  
 for GN, 2 pcs. frame, easy to assemble, distance between the tiers approx 26 cm, space-saving, robust  
 para bandejas GN, 2 piezas, fácil de montar, distancia entre pisos aprox. 26 cm, robusto  
 pour corbeilles ou plats GN, 2 étages, distance entre niveaux approx. 26 cm, robuste

	□ cm	↑ cm	GN	€
11553 8	29 x 27	35	1/2	44,00
11555 2	50 x 34	37,5	1/1	59,00



40152

GN1/2



40154

GN1/1

11100



40148

GN1/1

11027



40198

**Baguette-Korb "ECONOMIC"**  
**baguette basket**  
**cesta para baguette**  
**corbeille pour baguettes**



stabile Ausführung mit Edelstahldraht im Rand zur Stabilisierung  
 very solid with stainless steel wire frame to stabilize the basket  
 muy resistente con refuerzo de alambre inox  
 très résistante avec son fil de renfort inox

	☐ cm	↑ cm		€
40198 3	Ø 35	25 / 42	●	40,00
40199 0	Ø 35	25 / 42	●	40,00



**Brot- und Obstkorb "ECONOMIC"**  
**basket for bread or fruits**  
**cesta para pan o fruta**  
**corbeille à pain ou à fruits**



	☐ cm	↑ cm		€
40125 9	Ø 23	7		4,50



**Brot- und Obstkorb "ECONOMIC"**  
**basket for bread or fruits**  
**cesta para pan o fruta**  
**corbeille à pain ou à fruits**



	☐ cm	↑ cm		€
40127 3	27 x 20	10		4,50



40179

**Besteck-Korb „ECONOMIC“**  
**cutlery dispenser**  
**dispensador de cubiertos**  
**corbeille à couverts**



4 Fächer, 3 kleine Fächer, 1 großes Fach  
 4 troughs  
 4 huecos  
 4 classements



40182

	☐ cm	↑ cm		€
40179 2	26 x 18	15	●	11,50
40182 2	26 x 18	15	●	11,50



**Besteck-Korb "ECONOMIC"**  
cutlery dispenser  
dispensador de cubiertos  
corbeille à couverts



in Handarbeit geflochten  
wickerwork  
trensado a mano  
tressage à main

	□ cm	↑ cm		€
40130 3	Ø 12	15,0	●	3,00
40007 8	Ø 12	15,0	●	3,00

40007

40130



**Besteck-Korb "ECONOMIC"**  
cutlery dispenser  
dispensador de cubiertos  
corbeille à couverts



in Handarbeit geflochten  
wickerwork  
trensado a mano  
tressage à main

	□ cm	↑ cm		€
40131 0	27 x 10	4,5	●	3,00
40009 2	27 x 10	4,5	●	3,00

40131

40009



**Besteck-Korb „ECONOMIC“**  
cutlery dispenser  
dispensador de cubiertos  
corbeille à couverts



	□ cm	↑ cm		€
40286 7	Ø 12	15		4,60
40287 4	12 x 12	15		6,00

**NEW**



**Besteckköcher**  
cutlery basket  
cesta para cubiertos  
corbeille à couverts



	□ cm	↑ cm		€
84535 0	12 x 12	16	○	4,90
84536 7	12 x 12	16	●	4,90



EAN = 40 04 133 XXXXX X

397

**BROT- UND OBSTKORB „BASIC“**  
**BASKET FOR BREAD OR FRUITS**  
**CESTA PARA PAN O FRUTA**  
**CORBEILLE À PAIN OU À FRUITS**

in Handarbeit geflochten, einfache und leichte Ausführung  
wickerwork, simple and light version  
ligera, trensada a mano  
tressé à main, version légère

**HOT PRICE**



oval

**Brot- und Obstkorb oval „BASIC“**  
**basket for bread or fruits**  
**cesta para pan o fruta**  
**corbeille à pain ou à fruits**



	□ cm	↑ cm	€
30279 2	18 x 12	7	2,50
30280 8	23 x 15	6	2,60

**HOT PRICE**



oval

**Brot- und Obstkorb oval „BASIC“**  
**basket for bread or fruits**  
**cesta para pan o fruta**  
**corbeille à pain ou à fruits**



	□ cm	↑ cm	€
30282 2	21 x 10	6	2,40
30284 6	36 x 15	7	3,80

**HOT PRICE**



rund

**Brot- und Obstkorb rund „BASIC“**  
**basket for bread or fruits**  
**cesta para pan o fruta**  
**corbeille à pain ou à fruits**



	□ cm	↑ cm	€
30281 5	Ø 20	7	2,60
30285 3	Ø 25	7	3,80

**HOT PRICE**



rechteckig

**Tisch- und Buffet-Korb rechteckig „BASIC“**  
**buffet basket**  
**cesta de bufé**  
**corbeille de buffet**



	□ cm	↑ cm	€
30283 9	22,0 x 15,0	6	2,90
30286 0	30,0 x 22,0	7	3,60
30288 4	41,0 x 29,0	7	7,00

**HOT PRICE**



quadratisch

**Brot- und Obstkorb quadratisch „BASIC“**  
**basket for bread or fruits**  
**cesta para pan o fruta**  
**corbeille à pain ou à fruits**



	□ cm	↑ cm	€
30287 7	24 x 24	6	3,80

# WICKER LOOK

sehr formstabil, Kunststoff gespritzt



40234  
Ø 20 cm



**HOT PRICE**



40215  
oval, 23 x 17 cm



40213  
Ø 20 cm



40210  
beige



40211  
braun

40237  
oval, 23 x 17 cm



40214  
Ø 20 cm



40216  
oval, 23 x 17 cm



40212  
schwarz

**Brot- und Obstkorb „WICKER-LOOK“**  
basket for bread or fruits  
cesta para pan o fruta  
corbeille à pain ou à fruits



	□ cm	↑ cm		€
40234 8	Ø 20	6,5	● grün / green	2,50
40235 5	Ø 20	6,5	● rot / red	2,50
40213 3	Ø 20	6,5	● beige / beige	2,50
40214 0	Ø 20	6,5	● schwarz / black	2,50
40236 2	23 x 17	6,5	● grün / green	2,70
40237 9	23 x 17	6,5	● rot / red	2,70
40215 7	23 x 17	6,5	● beige / beige	2,80
40216 4	23 x 17	6,5	● schwarz / black	2,80
40210 2	39,5 x 29,5	10	● beige / beige	6,90
40211 9	39,5 x 29,5	10	● braun / brown	6,90
40212 6	39,5 x 29,5	10	● schwarz / black	6,90

**NEW**

für ca. 20 Eier



**Eier-Korb „PROFI LINE“**  
egg basket  
cesta de huevos  
panier à oeufs



mit Edelstahldraht im Rand, für ca. 20 Eier, hält den Inhalt durch das Stoff-Futter lange warm  
willow, stable, for around 20 eggs, keeps eggs warm  
ratán, calidad fuerte, para unos 20 huevos, mantiene los huevos calientes  
rotin, résistant, belle qualité, pour environ 20 oeufs, pour maintenir les oeufs bien chauds

	□ cm	↑ cm		€
40299 7	Ø 26	17	●	16,00

für ca. 20 Eier



**Eier-Korb**  
egg basket  
cesta de huevos  
panier à oeufs



stabile Vollweide, hält den Inhalt durch das sehr dicht verarbeitete Stoff-Futter lange warm  
willow, stable, keeps eggs warm  
ratán, calidad fuerte, mantiene los huevos calientes  
rotin, résistant, belle qualité, pour maintenir les oeufs bien chauds

	□ cm	↑ cm		€
30299 0	Ø 26	17		13,00

**NEW**



30342

rund / round



30343

rund / round

**Brottasche**  
bread basket  
panera  
corbeille à pain en toile



Baumwolle, umgekrempelt kann die Höhe individuell gestaltet werden, maschinenwaschbar bis 30°C, rund oder oval  
cotton, adjustable height, mashine-washable 30°C, round or oval  
algodón, altura ajustable, lavable a máquina 30°C, redondo u oval  
coton, hauteur ajustable, lavable en machine maxi 30°C, rond ou ovale

	□ cm	↑ cm		€
30342 3	Ø 17	8	●	6,60
30343 0	Ø 17	8	●	6,60
30352 2	Ø 20	9	●	7,40
30353 9	Ø 20	9	●	7,40
30362 1	20 x 15	7	●	7,00
30363 8	20 x 15	7	●	7,00
30372 0	25 x 18	9	●	7,90
30373 7	25 x 18	9	●	7,90



30362

oval



30363

oval





mit Zugverschluss

**Brottasche mit Wärmekissen**  
**bread basket with stones pillow**  
**panera con cojín**  
**corbeille à pain entoile**



Baumwolle, Keramik-Kugeln  
 cotton, ceramic stones  
 algodón  
 coton

	□ cm	↑ cm		€
30380 5	Ø 20	23,5	● beige	19,90
30390 4	Ø 20	23,5	● beige, braun / beige, brown	19,90

**Das Wärmekissen einfach  
 in der Mikrowelle erhitzen  
 (90 Sekunden / 500 Watt)**

**maschinenwaschbar bis 30°C  
 (außer Wärmekissen)**

**Einzelteile / spare parts / piezas sueltas / pièces détachées**

Wärmekissen, einfach in der Mikrowelle zu erhitzen (90 Sekunden / 500 Watt)  
 stones pillow, easy to heat up in the microwave (90 seconds / 500 watt)  
 cojín de piedrecillas a calentar, se calienta rápido en el microondas (90 seg. / 500 W.)  
 coussin de petites pierres, à chauffer, chauffe rapide en micro-ondes (90 sec. / 500W.)

30385 0	Ø 19	1,5		5,60
---------	------	-----	--	------



30203



30204

**Brot- und Obstkorb inklusive Brottasche**  
**basket for bread or fruits**  
**cesta para pan o fruta**  
**corbeille à pain ou à fruits**



mit Baumwoll-Einleger, maschinenwaschbar bis 30°C  
 with cotton-inliner, mashine-washable 30°C  
 algodón, lavable a máquina 30°C  
 coton, lavable en machine maxi 30°C

	□ cm	↑ cm		€
30203 7	Ø 20	9	● chrome / grey	14,90
30204 4	Ø 23	9	● chrome / grey	16,00

**Brottasche**  
**bread basket**  
**panera**  
**corbeille à pain en toile**



Baumwolle, umgekrempelt kann die Höhe individuell gestaltet werden, maschinenwaschbar bis 30°C, rund oder oval

cotton, adjustable height, mashine-washable 30°C, round or oval  
 algodón, altura ajustable, lavable a máquina 30°C, redondo u oval  
 coton, hauteur ajustable, lavable en machine maxi 30°C, rond ou ovale



30340, 30350



30361, 30371

	□ cm	↑ cm		€
30340 9	Ø 17	8	● beige	6,50
30350 8	Ø 20	9	● beige	7,20
30360 7	20 x 15	7	● beige	6,90
30370 6	25 x 18	9	● beige	7,70
30341 6	Ø 17	8	● beige, schwarz / beige, black	6,50
30351 5	Ø 20	9	● beige, schwarz / beige, black	7,20
30361 4	20 x 15	7	● beige, schwarz / beige, black	6,90
30371 3	25 x 18	9	● beige, schwarz / beige, black	7,70



**Brot- und Obstkorb**  
**basket for bread or fruits**  
**cesta para pan o fruta**  
**corbeille à pain ou à fruits**



rund

hochglanzpoliert  
 mirror polished finish  
 acabado pulido brillante  
 brillant

	□ cm	↑ cm		€
30200 6	Ø 17,5	7	rund / round / redondo / ronde	12,00
30220 4	Ø 20,5	8,5	rund / round / redonda / ronde	15,00
30230 3	Ø 25,5	9,5	rund / round / redonda / ronde	16,40
30210 5	20 x 15	7	oval	12,00
30240 2	24 x 19	8,5	oval	15,00
30250 1	28 x 21	9,5	oval	16,40



oval



**Obstkorb**  
**basket for fruits**  
**cesta para fruta**  
**corbeille à fruits**



hochglanzpoliert  
 mirror polished finish  
 acabado brillante  
 brillant

	□ cm	↑ cm	€
30270 9	Ø 21,5	20,5	32,00



**Grissini-Halter**  
**breadstick holder**  
**porta grissini**  
**porte-bâtonnets de pain (grissini)**



hochglanzpoliert  
 mirror polished finish  
 acabado brillante  
 brillant

	□ cm	↑ cm	€
30272 3	Ø 9,5	13,5	13,00



30201  
stainless steel

**Brot- und Obstkorb mit Tragegriff**  
basket for bread or fruits  
cesta para pan o fruta  
corbeille à pain ou à fruits



	□ cm	↑ cm		€
30201 3	24 x 24	21	Edelstahl / stainless steel	18,00
30202 0	24 x 24	21	● Kupfer-look / copper-look	18,00

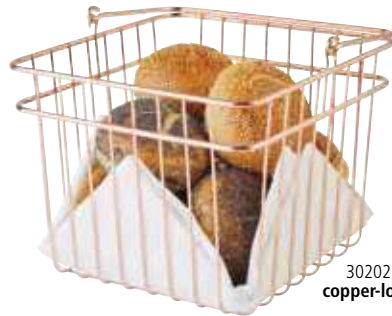

30202  
copper-look

**HOT PRICE**



rund

**Tischkorb**  
basket  
cesta  
corbeille



	□ cm	↑ cm		€
30310 2	Ø 18	7,5		5,70
30320 1	Ø 23	9		6,30

**HOT PRICE**



rund

30276

30277

**Brot- und Obstschale**  
bowl for bread or fruits  
bol para pan o frutas  
bol à pain ou à fruits



hochglanzpoliert, Hammerschlag Optik  
mirror polished finish, hammered look  
acabado pulido efecto espejo, aspecto repujado  
brillant, aspect martelé

	□ cm	↑ cm		€
30276 1	Ø 16	5		3,20
30277 8	Ø 20	5,5		5,40

**HOT PRICE**



oval

**Edelstahl-Schale**  
bowl  
bandeja ovalada inox  
corbeille ovale inox



ingerollter Rand  
rolled edge  
borde redondeado  
bord roulé

	□ cm	↑ cm		€
40110 5	26,5 x 18,5	4		7,40
40115 0	31 x 21	4,5		10,50

# TISCHSETS



60528 - grün/green

**Tischset Schmalband  
placemat smallband  
mantelín cinta estrecha  
set de table tressage étroit**



	cm		VE / Unit	€ / pc.
60525 1	45 x 33	weiß / white	6	2,90
60526 8	45 x 33	gold / gold	6	2,90
60527 5	45 x 33	silber / silver	6	2,90
60528 2	45 x 33	grün / green	6	2,90



60526 - gold/gold

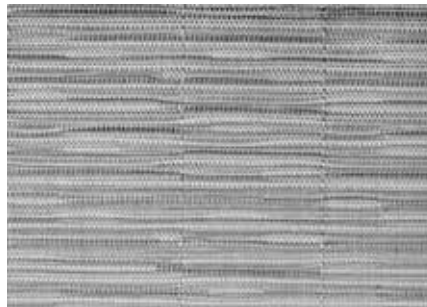

60525 - weiß/white



60527 - silber/silver



60538 - Bambus natur

**Tischset „BAMBUS“  
placemat  
mantelín  
set de table**



Original Natur-Bambus, handgemacht  
original nature bamboo, hand made  
bambú natural, hecho a mano  
bambou naturel, fabriqué à main

	cm		VE / Unit	€ / pc.
60538 1	45 x 33	natur / nature	6	4,40
60539 8	45 x 33	grün / green	6	4,40



60539 - Bambus grün



60004

**Tischset Schmalband  
placemat smallband  
mantelín cinta estrecha  
set de table tressage étroit**



	cm		VE / Unit	€ / pc.
60004 1	45 x 33	rot kariert / red checkered	6	2,90
60005 8	45 x 33	blau kariert / blue checkered	6	2,90
60006 5	45 x 33	schwarz kariert / black checkered	6	2,90



60004 - rot kariert / red checkered



60005 - blau kariert / blue checkered



60006 - schwarz kariert / black checkered



60535 - gold / gold

**Tischset „CROCO“  
placemat  
mantelín  
set de table**



rutschhemmende Unterseite  
slip resistant underside  
antideslizante por debajo  
dessous antiglisse

	cm		VE / Unit	€ / pc.
60535 0	45 x 30	gold / gold	6	5,00
60536 7	45 x 30	kupfer / copper	6	5,00
60537 4	45 x 30	braun / brown	6	5,00



60536 - kupfer / copper



60537 - braun / brown



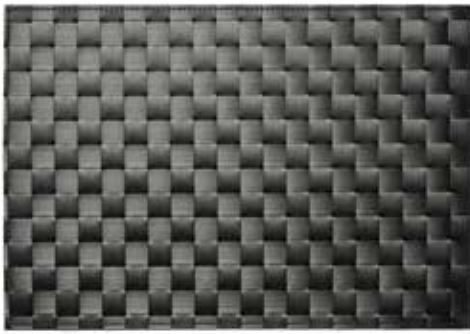

60008 - schwarz  
VE 6 / unit 6

**Tischset Breitband  
placemat wide band  
mantelín de mesa  
set de table**



	cm		VE / Unit	€ / pc.
60000 3	45 x 33	sahara / sahara	6	3,60
60001 0	45 x 33	beige / beige	6	3,60
60003 4	45 x 33	braun / brown	6	3,60
60007 2	45 x 33	blau / blue	6	3,60
60008 9	45 x 33	schwarz / black	6	3,60
60010 2	45 x 33	anthrazit / anthracite	6	3,60
60030 0	45 x 33	plum	6	3,60
60031 7	45 x 33	lime	6	3,60
60032 4	45 x 33	grasgrün / grass green	6	3,60



60000 - sahara

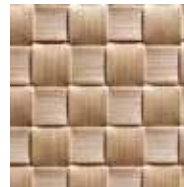

60001 - beige



60003 - braun



60007 - kobaltblau



60010 - anthrazit



60030 - plum



60031 - lime



60032 - grasgrün



60018 - candyrot  
VE 6 / unit 6

**Tischset Schmalband  
placemat smallband  
mantelín cinta estrecha  
set de table tressage étroit**



	cm		VE / Unit	€ / pc.
60002 7	45 x 33	hellblau / light blue	6	2,90
60009 6	45 x 33	rot / red	6	2,90
60011 9	45 x 33	orange / orange	6	2,90
60012 6	45 x 33	schwarz / black	6	2,90
60014 0	45 x 33	beige / beige	6	2,90
60015 7	45 x 33	silbergrau / silvergrey	6	2,90
60016 4	45 x 33	grün / green	6	2,90
60017 1	45 x 33	lila / purple	6	2,90
60018 8	45 x 33	candyrot / candyred	6	2,90
60019 5	45 x 33	beige, braun / beige, brown	6	2,90
60520 6	45 x 33	schwarz, weiß / black, white	6	2,90
60521 3	45 x 33	apfelgrün / apple green	6	2,90
60522 0	45 x 33	orange / orange	6	2,90
60523 7	45 x 33	purple, violett / purple, violet	6	2,90
60524 4	45 x 33	platin / platinum	6	2,90



60002 - hellblau

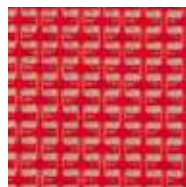

60009 - rot



60011 - orange



60012 - schwarz



60014 - beige



60015 - silbergrau

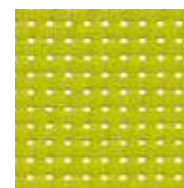

60016 - grün



60017 - lila



60019 - beige, braun

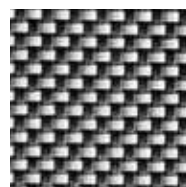

60520 - schwarz, weiß

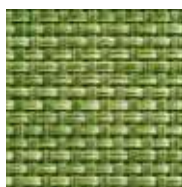

60521 - apfelgrün



60522 - orange

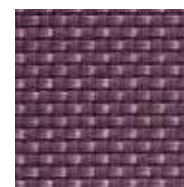

60523 - purple, violett

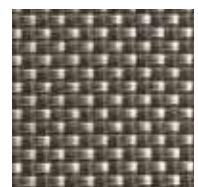

60524 - platin



60509 - Mosaik schwarz, grau  
VE 6 / unit 6

**Tischset Feinband**  
**placemat fine band**  
**mantelin**  
**set de table**



	cm		VE / Unit	€ / pc.
60509 1	45 x 33	Mosaik schwarz, grau / black, grey	6	2,90
60512 1	45 x 33	schwarz, grau / black, grey	6	2,90
60542 8	45 x 33	rot / red	6	2,90



60512 - schwarz, grau



60542 - rot



60510 - orange, rot gestreift  
VE 6 / unit 6

**Tischset Feinband**  
**placemat fine band**  
**mantelin cinta fina**  
**set de table, tressage fin**



	cm		VE / Unit	€ / pc.
60510 7	45 x 33	LINES orange, rot / LINES orange, red	6	2,90
60511 4	45 x 33	LINES orange, gelb / LINES orange, yellow	6	2,90
60530 5	45 x 33	STRIPES grau / STRIPES grey	6	2,90
60531 2	45 x 33	LINES schwarz / LINES black	6	2,90
60532 9	45 x 33	LINES pastell / LINES pastell	6	2,90
60533 6	45 x 33	LINES bordeaux / LINES bordeaux	6	2,90
60534 3	45 x 33	LINES rot / LINES red	6	2,90
60540 4	45 x 33	FRAMES grau / FRAMES grey	6	2,90
60541 1	45 x 33	FRAMES schwarz / FRAMES black	6	2,90



60511 - orange, gelb gestreift



60531 - schwarz gestreift

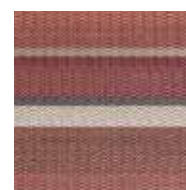

60532 - pastell gestreift



60533 - bordeaux gestreift



60534 - rot gestreift



60530 - grau gestreift



60540 - grau FRAMES

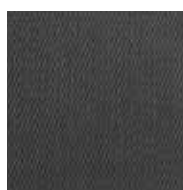

60541 - schwarz FRAMES

**NEW**

**Tischset Feinband  
placemat fine band  
mantelines  
sets de tables**



60033 - silber  
VE 6 / unit 6

	cm		VE / Unit	€ / pc.
60033 1	45 x 33	silber / silver	6	2,90
60034 8	45 x 33	braun / brown	6	2,90
60035 5	45 x 33	rot / red	6	2,90
60036 2	45 x 33	lila / purple	6	2,90
60037 9	45 x 33	gold / gold	6	2,90
60038 6	45 x 33	beige, braun / beige, brown	6	2,90
60039 3	45 x 33	rot, braun / red, brown	6	2,90
60040 9	45 x 33	blau / blue	6	2,90



60034 - braun



60035 - rot



60036 - lila



60037 - gold



60038 - beige, braun

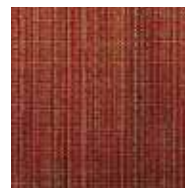

60039 - rot, braun



60040 - blau

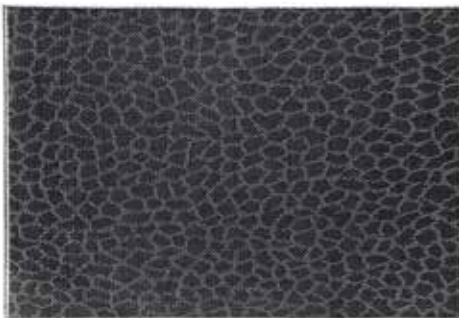

60501 - Mosaik, grau  
VE 6 / unit 6

**Tischset Feinband „TAO“  
placemat fine band  
mantelin cinta fina  
set de table, tressage fin**



	cm		VE / Unit	€ / pc.
60501 5	45 x 33	Mosaik, grau / mosaik, grey	6	3,80
60502 2	45 x 33	grau, beige / grey, beige	6	3,80
60503 9	45 x 33	beige / beige	6	3,80
60504 6	45 x 33	schwarz, gold / black, gold	6	3,80
60505 3	45 x 33	braun / brown	6	3,80



60502 - grau, beige

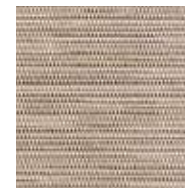

60503 - beige



60504 - schwarz, gold

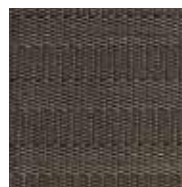

60505 - braun



**Tischset Feinband „GLÄSER“  
placemat fine band  
mantelin cinta fina  
sets de table, tressage fin**



	cm		VE / Unit	€ / pc.
60514 5	45 x 33	lemon-grün / lemon-green	6	2,90



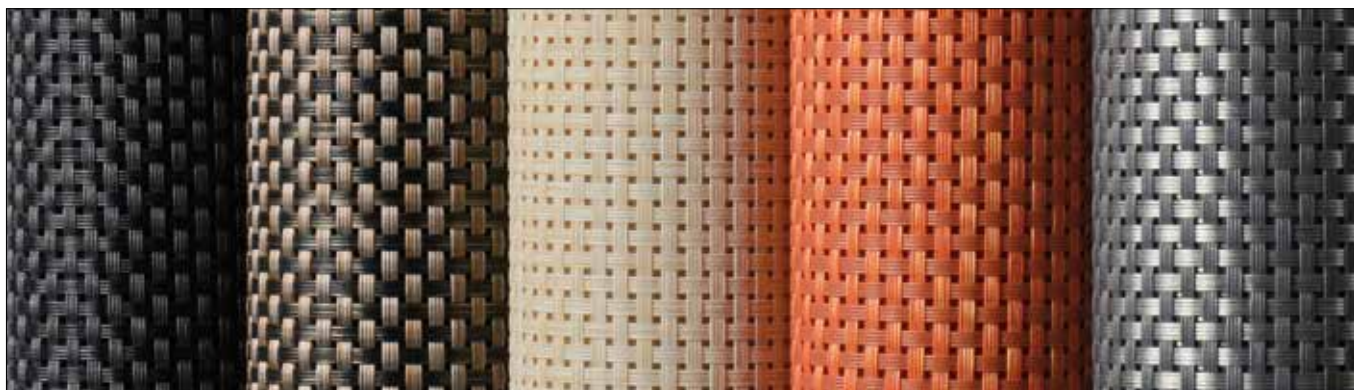

60022 - schwarz

60024 - beige, braun

60020 - beige

60021 - candyrot

60023 - silbergrau



VE 1 / unit 1

**Schmalband Tischläufer**  
**table runner fine fabric**  
**camino de mesa**  
**chemin de table**



pflegeleichtes Kunststoffgeflecht  
 easy to clean  
 fácil de limpiar  
 nettoyage aisé

	☐ cm		€
60020 1	45 x 150	beige / beige	11,90
60021 8	45 x 150	candyrot / candyred	11,90
60022 5	45 x 150	schwarz / black	11,90
60023 2	45 x 150	silbergrau / silver grey	11,90
60024 9	45 x 150	beige, braun / beige, brown	11,90



**Warenträger - Tischsets**  
**display for table sets**  
**expositor para mantelinas de mesa**  
**présentoir pour sets de table**



12 Einschubfächer, komplett auf Rollen, 2 Feststellrollen, Lieferung demontiert  
 12 shelves, on rolls, 2 rolls to fix, delivery unassembled  
 12 niveles, 4 ruedas, desmontado (montaje fácil)  
 12 niveaux, 4 roues, livré démonté

	☐ cm	↑ cm
00401 6	39,5 x 45	165

**je Fach: 25 Stück Breitband**  
**oder 40 Stück Schmalband, Feinband**

**each shelf: 25 pcs. wide band**  
**or 40 pcs. small band, fine band**



60551 - silber/grau

**Servietten- und Bestecktaschen, 6er Set**  
**cutlery bag, 6 pcs.**  
**bolsa cubiertos, 6 pz.**  
**pochette couverts, 6 pc.**



	cm		VE / Unit	€
60550 3	24 x 9	beige/beige	6	3,90
60551 0	24 x 9	silbergrau/silvergray	6	3,90
60552 7	24 x 9	beige braun/beige brown	6	3,90
60553 4	24 x 9	apfelgrün/aplegreen	6	3,90
60554 1	24 x 9	platin/platinum	6	3,90

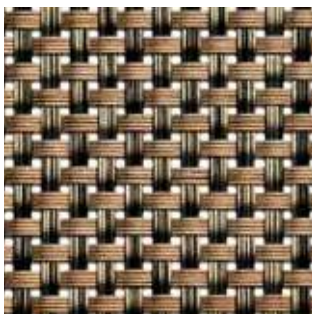

60552 - beige/braun



60550 - beige

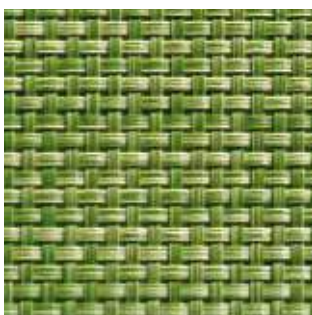

60553 - apfelgrün



60554 - platin



**Table Caddy**  
**table caddy**  
**caddy de mesa**  
**caddy de table**

HOLZ  
WOOD

Akazienholz  
 acacia wood  
 madera de acacia  
 bois d'acacia

	cm	↑ cm	€
40405 2	25 x 15	18	29,00

**NEW**



**Table Caddy**  
**table caddy**  
**caddy de mesa**  
**caddy de table**

HOLZ  
WOOD

Akazienholz  
 acacia wood  
 madera de acacia  
 bois d'acacia

	cm	↑ cm	Innen/inside cm	€
11625 2	23 x 10	10	21,5 x 8	9,60

NEW

**Table Caddy „VINTAGE“**  
table caddy  
caddy de mesa  
caddy de table



aus Pinienholz, herausnehmbare Aufteilung, 4-Fächer (7 x 7 cm)  
pinewood, separation removable, 4 compartments (7 x 7 cm)  
de madera de pino, separadores amovibles, 4 compartimentos (7 x 7 cm)  
en bois de pin, séparateurs amovibles, 4 compartiments (7 x 7 cm)

	□ cm	↑ cm		€
11635 1	17 x 17	10	○ white	19,90
11636 8	17 x 17	10	● turquoise	19,90
11637 5	17 x 17	10	● yellow	19,90



NEW

**Table Caddy „VINTAGE“**  
table caddy  
caddy de mesa  
caddy de table



aus Pinienholz, herausnehmbare Aufteilung, 6 Fächer (7,5 x 7,5 cm)  
pinewood, separation removable, 6 compartments (7,5 x 7,5 cm)  
de madera de pino, separadores amovibles, 6 compartimentos (7,5 x 7,5 cm)  
en bois de pin, séparateurs amovibles, 6 compartiments (7,5 x 7,5 cm)

	□ cm	↑ cm		€
11638 2	27 x 17	10	○ white	26,00
11639 9	27 x 17	10	● turquoise	26,00
11640 5	27 x 17	10	● yellow	26,00



designed by  EDUARD EUWENS  
PRODUCT DESIGN

**NEW**



**Pfeffer- & Salz-Menage „WOOD“**  
salt- & pepper-menage  
salero-pimentero  
ménage sel et poivre

HOLZ WOOD GLAS GLASS EDELSTAHL STAINLESS INOX 18/8

matt poliert, Glasbehälter mit Edelstahl-Deckel und Deckelverschluss  
satin polished finish, glass with stainless steel cover  
pulido acabado efecto satinado, cristal con tapa de acero inoxidable  
verre et inox mat satiné

	□ cm	↑ cm	€
40435 9	11,5 x 5,5	17	16,00

designed by  EDUARD EUWENS  
PRODUCT DESIGN

**NEW**



200 ml

**Essig- & Öl-Menage „WOOD“**  
oil- & vinegar-menage  
aceitera-vinagrera  
ménage huile et vinaigre

HOLZ WOOD GLAS GLASS PE POLYETHYL EDELSTAHL STAINLESS INOX 18/8

matt poliert, Glasbehälter mit Edelstahl-Deckel und Drehverschluss  
satin polished finish, glass with stainless steel cover  
pulido acabado efecto satinado, con tapa de acero inoxidable  
verre et inox mat satiné

	□ cm	↑ cm	€
40436 6	16 x 7,5	24,5	24,00

designed by  EDUARD EUWENS  
PRODUCT DESIGN

**NEW**



**Pfeffer-, Salz-, Essig- und Öl-Menage „WOOD“**  
salt- & pepper- & oil- & vinegar-menage  
salero-pimentero & aceitera-vinagrera  
ménage sel et poivre & huile et vinaigre

HOLZ WOOD GLAS GLASS PE POLYETHYL EDELSTAHL STAINLESS INOX 18/8

mattiert, möbelschonende Unterseite  
satin polished finish, glass with stainless steel cover  
pulido acabado efecto satinado, con tapa de acero inoxidable  
verre et inox mat satiné, avec couvercle inox

	□ cm	↑ cm	€
40437 3	15,5 x 12	24,5	32,00

**Einzelteile / spare parts / piezas sueltas / pièces détachées**

Ersatzglas mit Deckel / spare glass with cover  
vidrio con tapa / verre + couvercle

40438 0	Ø 4	9	6 Löcher - Ø 1,85 mm	3,40
---------	-----	---	----------------------	------

Ersatzglas mit Deckel / spare glass with cover  
vidrio con tapa / verre + couvercle

40439 7	Ø 4	9	18 Löcher - Ø 1,35 mm	3,40
---------	-----	---	-----------------------	------

Ersatzglas mit Deckel „Essig & Öl“  
spare glass with cover „vinegar & oil“  
cristal de recambio con tapa „aceite & vinagre“  
verre huile ou vinagre

	□ cm	↑ cm	ltr.	€
40442 7	Ø 6	18,5	0,2	4,50



**praktischer  
Außgießer**



40430

**Pfeffer- & Salz-Menage „FIVE STAR“**  
**salt- & pepper-menage**  
**salero-pimentero**  
**ménage sel et poivre**



matt poliert, Glasbehälter mit Edelstahl-Deckel und Drehverschluss  
 satin polished finish, glass with stainless steel cover  
 pulido acabado efecto satinado, cristal con tapa de acero inoxidable  
 verre et inox mat satiné

	□ cm	↑ cm	€
40430 4	10 x 5	14	17,50
40431 1	Ø 10	14	22,00



40431



40432

200 ml

**Essig- & Öl-Menage „FIVE STAR“**  
**oil- & vinegar-Menage**  
**aceitera-vinagrera**  
**ménage huile et vinaigre**



matt poliert, Glasbehälter mit Edelstahl-Deckel und tropffreiem Kunststoff-Ausgießer  
 satin polished finish, glass with stainless steel cover  
 pulido acabado efecto satinado, con tapa de acero inoxidable  
 verre et inox mat satiné, avec couvercle inox

	□ cm	↑ cm	Anzahl / Größe der Löcher	€
40432 8	14 x 6	24		26,00
40433 5	Ø 14	24		30,00

**Einzelteile / spare parts / piezas sueltas / pièces détachées**

Ersatzglas mit Deckel / spare glass with cover  
 vidrio con tapa / verre + couvercle

40438 0	Ø 4	9	6 Löcher - Ø 1,85 mm	3,40
---------	-----	---	----------------------	------

Ersatzglas mit Deckel / spare glass with cover  
 vidrio con tapa / verre + couvercle

40439 7	Ø 4	9	18 Löcher - Ø 1,35 mm	3,40
---------	-----	---	-----------------------	------

Ersatzglas mit Deckel „Essig & Öl“  
 spare glass with cover „vinegar & oil“  
 cristal de recambio con tapa „aceite & vinagre“  
 verre huile ou vinagre

	□ cm	↑ cm	ltr.	€
40442 7	Ø 6	18,5	0,2	4,50

Ersatzglas mit Deckel „Zahnstocher“ / spare glass with cover „toothpick“  
 porta-palillos vidrio con tapa / verre à cure-dents + couvercle

40313 0	Ø 4	9		3,40
---------	-----	---	--	------



40433



40310



40320

**Pfeffer- & Salz-Menage „CLASSIC“**  
**salt- & pepper-menage**  
**salero-pimentero**  
**ménage sel et poivre**



Glasbehälter mit Edelstahl-Deckel und Drehverschluss  
 glass with stainless steel cover  
 vidrio con tapa de acero inoxidable con rosca  
 en verre avec couvercle inox à visser

	▣ cm	↑ cm	€
40310 9	10,5 x 6,5	16	16,90
40320 8	Ø 10,5	16	21,00



40440

**Menage „CLASSIC“**  
**menage**  
**menage**  
**ménage**



Glasbehälter mit Edelstahl-Deckel und tropffreiem Kunststoff-Ausgießer  
 with stainless steel cover and non-drip nozzle-spout  
 vidrio con tapa inox y sistema antigoteo  
 verre avec couvercle inox et verseur antigoutte

	▣ cm	↑ cm	ltr.	€
40440 3	14,5 x 8,5	23	0,25	25,00
40450 2	17,5 x 10,5	23		28,50

**Einzelteile / spare parts / piezas sueltas / pièces détachées**

Ersatzglas mit Deckel / spare glass with cover  
 vidrio con tapa / verre + couvercle

40311 6	Ø 4	9	6 Löcher - Ø 1,85mm	3,40
---------	-----	---	---------------------	------

Ersatzglas mit Deckel / spare glass with cover  
 vidrio con tapa / verre + couvercle

40312 3	Ø 4	9	18 Löcher - Ø 1,35 mm	3,40
---------	-----	---	-----------------------	------

Ersatzglas mit Deckel „Essig & Öl“  
 spare glass with cover „vinegar & oil“  
 cristal de recambio con tapa „aceite & vinagre“  
 verre huile ou vinagre

	▣ cm	↑ cm	ltr.	€
40441 0	Ø 6	18,5	0,2	4,50

Ersatzglas mit Deckel „Zahnstocher“ / spare glass with cover „toothpick“  
 porta-palillos vidrio con tapa / verre à cure-dents + couvercle

40313 0	Ø 4	9		3,40
---------	-----	---	--	------



40450

designed by **KIRCHHOFF & EUWENS**



40420

40421

**Pfeffer- und Salz-Menage „PROFI“**  
**pepper & salt menage**  
**salero-pimentero**  
**ménage sel et poivre**



mit Edelstahl-Deckel  
 with stainless steel cover  
 con tapa de acero inoxidable  
 avec couvercle inox

	□ cm	↑ cm	€
40420 5	9 x 4	15	12,00
40421 2	12,5 x 4	17	17,00

designed by **KIRCHHOFF & EUWENS**



40422  
200 ml

40423

**Essig- und Öl-Menage „PROFI“**  
**vinegar & oil menage**  
**aceitera-vinagrera**  
**ménage huile et vinaigre**



mit Edelstahl-Deckel, Kunststoff-Ausgießer  
 with stainless steel cover, plastic pourer  
 con tapa de acero inoxidable, pico vertedor de plástico  
 couvercle inox, bec verseur plastique

	□ cm	↑ cm	Anzahl / Größe der Löcher	€
40422 9	13,5 x 5,5	22		22,00
40423 6	13 x 13	22		25,00

**Einzelteile / spare parts / piezas sueltas / pièces détachées**

Ersatzglas mit Deckel / spare glass with cover  
 vidrio con tapa / verre + couvercle

40311 6	Ø 4	9	6 Löcher - Ø 1,85mm	3,40
---------	-----	---	---------------------	------

Ersatzglas mit Deckel / spare glass with cover  
 vidrio con tapa / verre + couvercle

40312 3	Ø 4	9	18 Löcher - Ø 1,35 mm	3,40
---------	-----	---	-----------------------	------

Ersatzglas mit Deckel „Essig & Öl“  
 spare glass with cover „vinegar & oil“  
 cristal de recambio con tapa „aceite & vinagre“  
 verre huile ou vinaigre

	□ cm	↑ cm	ltr.	€
40441 0	Ø 6	18,5	0,2	4,50

Ersatzglas mit Deckel „Zahnstocher“ / spare glass with cover „toothpick“  
 porta-palillos vidrio con tapa / verre à cure-dents + couvercle

40313 0	Ø 4	9		3,40
---------	-----	---	--	------



**praktischer  
 Außgießer**

Kaffee - Körbe  
 coffee .basket



40470

**Menage „PRO“**  
**menage**  
**menage**  
**ménage**



matt poliert, Glasbehälter mit Edelstahl-Deckel und Drehverschluss  
 satin polished finish, glass with stainless steel cover  
 inox satinado, vidrio y tapas con rosca  
 inox poli mat satiné et verre, couvercle à visser

	▣ cm	↑ cm	€
40470 0	8,5 x 5,7	11,5	5,40
40472 4	9,2 x 8,5	11,5	6,80
40474 8	10 x 10	11,5	7,60



40472



40474



40476

**Menage „PRO“**  
**menage**  
**menage**  
**ménage**



matt poliert, Glasbehälter mit Edelstahl-Deckel und tropffreiem Kunststoff-Ausgießer  
 satin polished finish, glass with stainless steel cover and non-drip nozzle-spout  
 inox satinado, vidrio, sistema antigoteo  
 inox poli mat satiné et verre, insert plastique antigoutte

	▣ cm	↑ cm	€
40476 2	12 x 8	19	10,60
40478 6	12,5 x 11	19	15,00
40480 9	13 x 11	19	15,70



40478

**Einzelteile / spare parts / piezas sueltas / pièces détachées**

Pfeffer- oder Salz-Glasstreuer / pepper- or salt-glass with cover  
 salero o pimentero de cristal con tapa / salière ou poivrière seule en verre avec couvercle inox

40461 8	1,80
---------	------

Essig- oder Öl-Glasbehälter / oil- or vinegar-glass with cover  
 aceitera-vinagrera con tapa / bouteille huile ou vinaigre seule en verre et couv. inox

40462 5	3,10
---------	------



40480



**HOT  
PRICE**

**Senftöpfchen, 2er Set**  
**mustard glass, 2 pcs. set**  
**juego 2 piezas vasos mostaza**  
**jeu de 2 verres à moutarde**



inkl. Löffel und Edelstahl-Deckel  
 incl. spoons and covers  
 incluye cucharas y tapas  
 cuillères et couvercles inclus

	□ cm	↑ cm	pcs.	€
40415 1	Ø 5	6	2	5,00



**Menage „ECONOMIC“**  
**menage**  
**menage**  
**ménage**



Glasbehälter mit Edelstahl-Deckel und Drehverschluss  
 glass with stainless steel cover  
 cristal con tapa inox a rosca  
 en verre avec couvercle inox à visser

	□ cm	↑ cm	€
40455 7	8 x 4	13	4,20
40457 1	8 x 8	12	6,40



**Menage „ECONOMIC“**  
**menage**  
**menage**  
**ménage**



Glasbehälter mit Edelstahl-Deckel und tropffreiem Kunststoff-Ausgießer  
 glasses with stainless steel cover and non-drip nozzle-spout  
 cristales con tapa de acero inoxidable y sistema antigoteo  
 en verre avec couvercle inox et insert plastique antigoutte

	□ cm	↑ cm	€
40458 8	11,5 x 5,5	22	8,20
40460 1	11 x 10,5	22	12,40

**Einzelteile / spare parts / piezas sueltas / pièces détachées**

Pfeffer- oder Salz-Glasstreuer / pepper- or salt-glass with cover  
 salero o pimentero de cristal con tapa / salière ou poivrière seule en verre avec couvercle inox

40461 8	1,80
---------	------

Essig- oder Öl-Glasbehälter / oil- or vinegar-glass with cover  
 aceitera-vinagrera con tapa / bouteille huile ou vinaigre seule en verre et couv. inox

40462 5	3,10
---------	------

Glas für Zahnstocher

40463 2	1,10
---------	------

Glas für Senf

40464 9	1,60
---------	------



inkl.  
Löffel



**Parmesan-Menage „CLASSIC“**  
cheese dish  
quesera parmesano  
service à parmesan



hochglanzpoliert, inkl. Löffel  
mirror polished finish, with spoon  
pulido efecto espejo, con bol cristal y cuchara  
brillant, avec bol verre et cuillère

	□ cm	↑ cm	€
40330 7	Ø 10,5	7	15,90

**Einzelteile / spare parts / piezas sueltas / pièces détachées**

Ersatzbehälter / sparecontainer / bol de recambio / bol de rechange

40331 4			4,50
---------	--	--	------

designed by **KIRCHHOFF & EUWENS**

inkl.  
Löffel



**Parmesan-Menage „PROFI“**  
cheese dish  
quesera parmesano  
service à parmesan



	□ cm	↑ cm	€
40424 3	Ø 9	5,5	13,50

**Einzelteile / spare parts / piezas sueltas / pièces détachées**

Ersatzbehälter / sparecontainer / bol de recambio / bol de rechange

40331 4			4,50
---------	--	--	------

inkl.  
Löffel



**Parmesan-Menage „PRO“**  
cheese dish  
quesera parmesano  
service à parmesan



matt poliert, inkl. Löffel  
satin polished finish, with spoon  
pulido mate satinado, con bol cristal y cuchara  
mat satiné, avec bol verre et cuillère

	□ cm	↑ cm	€
40482 3	Ø 10,5	13	8,80

**Einzelteile / spare parts / piezas sueltas / pièces détachées**

Ersatzbehälter / sparecontainer / bol de recambio / bol de rechange

40331 4			4,50
---------	--	--	------



inkl.  
Löffel



**Parmesan-Menage „ECONOMIC“**  
cheese dish  
quesera parmesano  
service à parmesan



inkl. Kunststofflöffel  
with spoon  
con cuchara  
avec cuillère

	□ cm	↑ cm	€
40453 3	Ø 10,5	7	5,70

**Einzelteile / spare parts / piezas sueltas / pièces détachées**

Ersatzbehälter / sparecontainer / bol de recambio / bol de rechange

40454 0			2,10
---------	--	--	------

für 500 ml  
Flaschen



**Ständer**  
**servicing stand**  
**soporte 2 botellas**  
**support 2 bouteilles**



matt poliert, passend für handelsübliche 500 ml Flaschen, Lieferung ohne Flaschen  
satin polished finish, for standard bottles with 500 ml content, delivery without bottles  
inox satinado, para botellas estándar de 500 ml, se entrega sin botellas  
inox mat satiné, pour bouteilles standard de 500 ml, livré sans bouteilles

	□ cm	↑ cm	€
40444 1	14,5 x 8,5	35	21,90

für 250 ml  
Flaschen



**Ständer**  
**servicing stand**  
**soporte 2 botellas**  
**support 2 bouteilles**



hochglanzpoliert, passend für handelsübliche 250 ml Flaschen, Lieferung ohne Flaschen  
mirror polished finish, for standard bottles with 250 ml content, delivery without bottles  
inox satinado, para botellas estándar de 250 ml, se entrega sin botellas  
inox mat satiné, pour bouteilles standard de 250 ml, livré sans bouteilles

	□ cm	↑ cm	€
40443 4	13 x 7	30	18,90



**Gewürz-Ständer**  
**servicing stand/rack**  
**soporte salsas y condimentos**  
**porte condiments et sauces**



matt poliert, Lieferung ohne Deko  
satin polished finish  
acabado pulido efecto satinado  
poli mat satiné

	□ cm	↑ cm	€
40300 0	Ø 19	20	18,70

**HOT PRICE**



**Menage**  
**menage**  
**menage**  
**ménage**



drehbares Gestell, Glasbehälter mit Edelstahl-Deckel und Drehverschluss  
rotating frame, glass with stainless steel cover  
soporte giratorio con piezas de vidrio y tapas inox  
tournant, avec pièces en verre et couvercle inox

	□ cm	↑ cm	€
40485 4	Ø 16	20	17,10

**NEW**



200 ml

**Zuckerdosierer  
sugar dispenser  
azucarero  
sucrier**



mit Schraubverschluss, Dosier-Rohr Ø 15 mm  
cover and dosingtube Ø 15 mm  
con tapa y tubo dosificador Ø 15 mm  
couvercle avec tube doseur Ø 15 mm

	cm	cm	litr.	€
40508 0	Ø 6,5	14,5	0,20	9,90



40480  
250 ml



40480  
150 ml

**Zuckerdosierer  
sugar dispenser  
azucarero  
sucrier**



Schraubdeckel aus Edelstahl, mit Dosierrohr  
cover stainless steel with dosingtube  
tapa inoxidable y tubo dosificador  
couvercle inox et tube doseur

	cm	cm	litr.	€
40490 8	Ø 8,5	12	0,15	2,90
40494 6	Ø 8	15	0,25	2,90

**Einzelteile / spare parts / piezas sueltas / pièces détachées**

Ersatzbehälter / spare-container / contenedor de repuesto / récipient verre de rechange

40498 4	für / for / para / pour 40490	1,60
40499 1	für / for / para / pour 40494	1,60



00765  
300 ml



00766  
300 ml

**Allzweckgießer  
pouer  
bote vertedor universal  
pot verseur universel**



Schraubdeckel aus Edelstahl  
cover stainless steel  
tapa inoxidable  
couvercle inox

	cm	cm		€
00765 9	Ø 8,5	13,5	für Honig, Kaffeesahne, etc. for honey, cream, etc. para miel, crema, etc. pour le miel, le lait, la crème, etc.	6,60
00766 6	Ø 8,5	15	zum Portionieren von Zucker for sugar para azúcar pour le sucre	3,50

**Einzelteile / spare parts / piezas sueltas / pièces détachées**

Ersatzbehälter / spare-container / contenedor de repuesto / récipient verre de rechange

00768 0	1,80
---------	------

250 ml



**Allzweckgießer**  
**pourer**  
**dosificador**  
**doseur**



Schraubdeckel aus Edelstahl und Kunststoff, mit Dosierklappe  
 cover stainless steel and plastic, with dosing flap  
 acero inoxidable y tapa plástico, con cierre dosificador  
 couvercle en inox et plastique, avec couvercle doseur

	□ cm	↑ cm	ltr.	€
40488 5	Ø 8	12,5	0,25	5,60

320 ml



**Zuckerdosierer**  
**sugar dispenser**  
**azucarero**  
**sucrier**



Schraubdeckel aus Edelstahl, mit Dosier-Rohr  
 cover stainless steel, with dosing tube  
 tapa inoxidable y tubo dosificador  
 couvercle inoxydable et tube doseur

	□ cm	↑ cm	ltr.	€
40506 6	Ø 7,5	17,0	0,32	4,20

320 ml



**Zuckerdosierer**  
**sugar dispenser**  
**azucarero**  
**sucrier**



Schraubdeckel mit Klappe aus Edelstahl, mit Dosierklappe  
 cover stainless steel, with dosing flap  
 tapa acero inoxidable, con cierre dosificador  
 couvercle inox, avec couvercle doseur

	□ cm	↑ cm	ltr.	€
40487 8	Ø 7,5	13,5	0,32	3,60

250 ml



**Zuckerdosierer**  
**sugar dispenser**  
**azucarero**  
**sucrier**



Schraubdeckel aus Edelstahl, mit Dosierrohr  
 cover stainless steel, with dosing tube  
 tapa inoxidable y tubo, con cierre dosificador  
 couvercle inox et tube doseur

	□ cm	↑ cm	ltr.	€
40486 1	Ø 8	15	0,25	2,90

# GEWÜRZMÜHLEN PROFESSIONAL

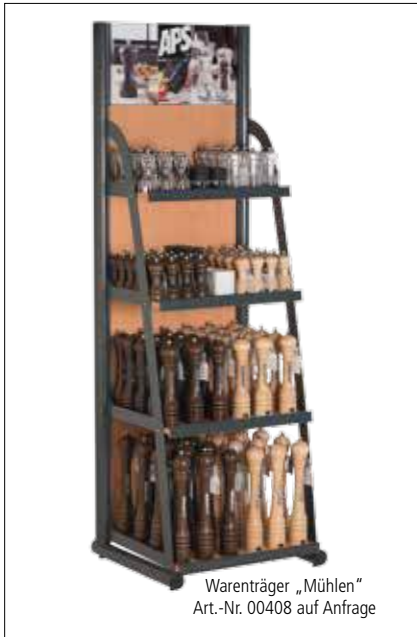

Warenträger „Mühlen“  
Art.-Nr. 00408 auf Anfrage



Salz-/ Pfeffermühlen gefertigt aus deutschem Buchenholz. Einfach gekennzeichnet durch S=Salz / P=Pfeffer an der Justierschraube. Die Pfeffermühlen haben ein Mahlwerk aus Carbon - scharfes und langlebiges Mahlwerk (Rockwellhärte 55) - Pfefferkörner werden erst „geschält“ anschließend „fein gemahlen“. Das Mahlwerk der Salzmühle eignet sich zum Mahlen von groben und trockenem Meersalz. Das Carbonstahl-Mahlwerk ist beständig gegen Korrosion.

**Alle Mühlen werden ungefüllt geliefert.**



**Mahlgrad einstellen:**  
feines Mahlen: Schraube im Uhrzeigersinn drehen  
grobes Mahlen: Schraube entgegen dem Uhrzeigersinn drehen

**Adjustment knob**  
Turn knob clockwise for finer grind, counter clockwise for coarser grind

**Bouton d'ajustement**  
tourner le bouton dans le sens antihoraire pour une mouture plus grosse

**Mühlenskopf:**  
um zu Mahlen, Mühlenskopf im Uhrzeigersinn drehen

**Pepper mill head**  
to grind, turn mill head clockwise

**Tête du moulin**  
pour moudre, tourner la tête du moulin dans le sens horaire

**Schaft:**  
- aus Edelstahl  
- korrosionsfest

**Shaft**  
- stainless steel shaft  
- corrosion resistant

**Tige**  
- en acier inoxydable  
- résistant à la corrosion

**Federmechanismus:**  
gewährleistet ein konstantes Mahlergebnis

**Spring loaded mechanism**  
ensures a consistent grind selection

**Mécanisme à ressort**  
assure une mouture homogène

## Verfügbare Ausführungen

- Deutsches Buchenholz in natur oder dunkel
- kristallklares Acryl

## Available finishes:

- German beechwood, in chocolate or natural finish
- crystal clear acrylic

## Disponible en

- bois massif de hêtre d'Allemagne, finis espresso ou naturel
- acier inoxydable
- acrylique „Crystal“

## Mahlwerk für Salz

hochwertiges, langlebiges Edelstahlmahlwerk

## Mahlwerk für Pfeffer

Carbonstahl, eines der schärfsten und langlebigsten Mahlwerke auf dem Markt

## Grinder for salt

High quality wear resistant stainless steel alloy

## Grinder for peppercorn

carbon steel, the sharpest and most durable grinder on the market

## Moulin à sel

alliage d'acier inoxydable résistant à l'usure et à la corrosion

## Moulin à poivre

acier au carbone offre un affûtage plus durable et résistant à la corrosion



**Pfeffermühle „PROFESSIONAL“**  
pepper mill  
molinillo de pimienta  
moulin à poivre



	□ cm	↑ cm			€
40530 1	Ø 5,5	15	●	Holz / wood	20,00
40532 5	Ø 7	30	●	Holz / wood	30,00
40534 9	Ø 7	40	●	Holz / wood	52,00
40520 2	Ø 5,5	15	●	Holz / wood	20,00
40522 6	Ø 7	30	●	Holz / wood	30,00
40524 0	Ø 7	40	●	Holz / wood	52,00
40540 0	Ø 5,5	15	○	Acryl / acrylic	21,00



**Salzmühle „PROFESSIONAL“**  
salt mill  
molinillo de sal  
moulin à sel

	□ cm	↑ cm			€
40531 8	Ø 5,5	15	●	Holz / wood	20,00
40521 9	Ø 5,5	15	●	Holz / wood	20,00
40541 7	Ø 5,5	15	○	Acryl / acrylic	21,00



40542

**Chilimühle**  
chili mill  
molinillo de chile  
moulin à piment



	□ cm	↑ cm		€
40542 4	Ø 4,5	18,5		13,00



40531  
Salzmühle

40530  
Pfeffermühle

**Tablett**  
tray  
bandeja  
plateau



mit 2 Absätzen Ø 6 cm / with 2 holes Ø 6 cm  
con 2 agujeros Ø 6 cm / avec 2 trous Ø 6 cm

	□ cm	↑ cm	€
84039 3	16,5 x 8,5	1,5	3,50



40541  
Salzmühle

40540  
Pfeffermühle

00971

**Naturschieferplatte / Untersetzer**  
natural slate tray  
bandeja de pizarra natural  
plateau ardoise naturelle



mit 2 Absätzen Ø 6 cm / with 2 holes Ø 6 cm / con 2 agujeros Ø 6 cm / avec 2 trous Ø 6 cm

	□ cm	✂ mm	€
00971 4	15 x 8	4 - 7	3,00

**NEW**



40546



40535

**Pfeffermühle „PROFESSIONAL VINTAGE“**  
**pepper mill**  
**molinillo de pimienta**  
**moulin à poivre**

HOLZ  
WOOD

Deutsches Buchenholz, vintage, Mahlwerk aus Carbonstahl, Mahlgrad stufenlos einstellbar  
 German beechwood, vintage, mill in carbon steel, the grinding degree can be adjusted infinitely  
 madera de haya alemana, carácter "vintage", molinillo de acero al carbono, el grado de molino se puede ajustar de modo continuo  
 bois de hêtre d'Allemagne, vintage, moulin en acier de carbone, la finesse de mouture se peut réglée de façon continue

	☐ cm	↑ cm			€
40535 6	Ø 5,5	15	○	vintage white	22,00
40537 0	Ø 6	23	○	vintage white	26,00
40546 2	Ø 5,5	15	●	vintage green	22,00
40548 6	Ø 6	23	●	vintage green	26,00



**NEW**



40547



40536

**Salzmühle „PROFESSIONAL VINTAGE“**  
**salt mill**  
**molinillo de sal**  
**moulin à sel**

HOLZ  
WOOD

Deutsches Buchenholz, vintage, Mahlwerk aus Edelstahl, Mahlgrad stufenlos einstellbar  
 German beechwood, vintage, mill in stainless steel, the grinding degree can be adjusted infinitely  
 madera de haya alemana, carácter "vintage", molinillo de acero inoxidable, el grado de molino se puede ajustar de modo continuo  
 bois de hêtre d'Allemagne, vintage, moulin en acier inoxydable, la finesse de mouture se peut réglée de façon continue

	☐ cm	↑ cm			€
40536 3	Ø 5,5	15	○	vintage white	22,00
40547 9	Ø 5,5	15	●	vintage green	22,00







**2 in 1 Salz- u. Pfeffermühle**  
**2 in 1 salt / pepper mill**  
**2 in 1 molinillo de sal / pimienta**  
**2 in 1 moulin à sel / poivre**

ACRYL  
ACRYLIC

EDELSTAHL  
STAINLESS  
INOX

Keramik-Mahlwerk  
 ceramic mechanism  
 molinillo de cerámica  
 broyeur en céramique

	□ cm	↑ cm	€
40545 5	Ø 7,5	18,5	19,00



Mahlgrad einstellbar /  
 grinder setting

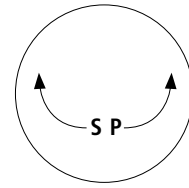

**2 in 1 Salz- u. Pfeffermühle**  
**2 in 1 salt / pepper mill**  
**2 in 1 molinillo de sal / pimienta**  
**2 in 1 moulin à sel / poivre**

ACRYL  
ACRYLIC

EDELSTAHL  
STAINLESS  
INOX

Keramik-Mahlwerk  
 ceramic mechanism  
 molinillo de cerámica  
 broyeur en céramique

	□ cm	↑ cm	€
40544 8	6 x 4,5	9,5	17,00



Mahlgrad einstellbar /  
 grinder setting

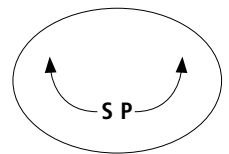

**2 in 1 Salz- u. Pfeffermühle**  
**2 in 1 salt / pepper mill**  
**2 in 1 molinillo de sal / pimienta**  
**2 in 1 moulin à sel / poivre**

ACRYL  
ACRYLIC

ABS  
KUNSTSTOFF

	□ cm	↑ cm	€
40543 1	6 x 5	8	15,50

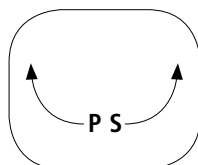

EAN = 40 04 133 XXXXX X



**Multistreuer**  
multi-functional shaker  
shaker  
shaker



	cm	cm	ltr.	€
00774 1	Ø 7	12	0,20	12,00



closed

Ø 2 mm

Ø 4 mm

Ø 6 mm



**Multistreuer**  
multi-functional shaker  
shaker  
shaker



	cm	cm	ltr.	€
00773 4	Ø 6	8	0,05	8,00



closed

Ø 2 mm

Ø 4 mm

Ø 6 mm



**Käse- oder Gewürzstreuer**  
spice shaker  
botes especieros  
saupoudreuse à épices



inkl. Staubdeckel / incl. cover  
agujeros Ø 5,5 mm + tapa plástico / trous Ø 5,5 mm + couvercle plastique

	cm	cm	ltr.	€
00775 8	Ø 5,5	7,5	0,15	5,40

Netzstreuer / mesh top shaker  
polvoreador, tapa con malla fina / pot à épices, couvercle toile fine

00776 5	Ø 5,5	7,5	0,15	5,40
---------	-------	-----	------	------

Streuer fein / small hole shaker  
polvoreador, tapa con agujeros pequeños / pot à épices, couvercle à petits trous

00777 2	Ø 5,5	7,5	0,15	4,90
---------	-------	-----	------	------

Streuer grob / large hole shaker  
polvoreador, tapa con agujeros grandes / pot à épices, couvercle à grands trous

00778 9	Ø 5,5	7,5	0,15	4,90
---------	-------	-----	------	------

NEW



**Netzstreuer**  
mesh top shaker  
polvoreador, tapa con malla fina  
pot à épices, couvercle toile fine



	☐ cm	↑ cm	ltr.	€
00781 9	Ø 6,5	12	0,20	11,00



NEW



**Multistreuer / Gewürzstreuer**  
multi-functional shaker  
juego dosificador  
jeu de salières



	☐ cm	↑ cm	ltr.	Loch / hole	€
00782 6	Ø 6,5	12	0,20	Ø 2 mm	10,00
00783 3	Ø 6,5	12	0,20	Ø 8 mm mit 8 Löchern / with 8 holes con 8 agujeros / avec 8 trous	10,00



00783

00782



00782  
Ø 2 mm



00783  
Ø 8 mm



00779  
Aluminium



00772  
Edelstahl

**Salzstreuer**  
salt cellar  
salero  
salière



Pommes-Frites Streuer mit Schraubkappe  
for french fries, cover to screw  
para patatas fritas, tapa de rosca  
pour les frites, couvercle à visser

	☐ cm	↑ cm		€
00779 6	Ø 8	17	Aluminium / aluminium aluminio / aluminium	8,90
00772 7	Ø 8	17	Edelstahl / stainless steel acero inoxidable / inox	11,40



00779



00772

**NEW**



2er Set / 2 pcs. set

**Salz- und Pfefferstreuer, 2er Set**  
**salt - and pepper shaker, 2 pcs. set**  
**juego de 2 piezas de sal y pimienta**  
**set de 2 sel et poivre**



Edelstahl-Deckel  
 stainless steel cover  
 tapa acero inoxidable  
 couvercle inox

	cm	cm	pcs.	€
40507 3	Ø 6	10	2	7,90



**Salz- und Pfefferstreuer, 2er Set**  
**salt - and pepper shaker, 2 pcs. set**  
**juego de 2 piezas de sal y pimienta**  
**set sel et poivre, 2 pz.**



Edelstahl-Deckel  
 stainless steel cover  
 tapa acero inoxidable  
 couvercle inox

	cm	cm	pcs.		€
40500 4	Ø 5	6,5	2	glatte Ausführung / smooth version versión recta / forme lisse	2,40
40501 1	Ø 5	6,5	2	geriffelte Ausführung / fluted version versión ondulada / forme ondulée	2,40



12er Set

**Allzweckstreuer, 12er Set**  
**shaker, 12 pcs set**  
**juego 12 piezas dosificador**  
**jeu de 12 salières/poivrières**



	cm	cm	pcs.		€
40504 2	4 x 4	10	12	13 Löcher / 13 holes / 13 agujeros / 13 trous	20,00
40505 9	4 x 4	10	12	3 Löcher / 3 holes / 3 agujeros / 3 trous	16,00



40504  
12er Set



40505  
12er Set



14 g Inhalt

**Ministreuer, 4er Set**  
**smaller shaker, 4 pcs. Set**  
**juego de 4 piezas bodegas pequeñas**  
**jeu de 4 mini-salières**



	cm	cm	pcs.	€
40503 5	Ø 3,5	4	4	4,00

in 3 Größen erhältlich



**Milch-/Universalkanne „ANTIHAFT“**  
**non stick jug**  
**jarra antiadherente**  
**pichet antiadhésif**



PTFE-antihaftbeschichtet, perfekt für die Herstellung von Milchschaum  
 PTFE coated, for baristas frothing hot milk  
 revestimiento PTFE, ideal para espume de leche  
 revêtement PTFE, idéal pour faire mouser le lait

	□ cm	↑ cm	ltr.	€
10334 4	Ø 8	10	0,35	13,40
10335 1	Ø 9	11,5	0,6	16,50
10336 8	Ø 10,5	13	0,8	21,80

in 5 Größen erhältlich



**Milch- / Universalkanne**  
**milk / water jug**  
**jarra leche / agua**  
**pichet à eau / lait**



außen hochglanzpoliert, innen matt poliert  
 outside mirror polished finish, inside satin polished finish  
 exterior brillante, interior satinado  
 extérieur brillant, intérieur mat satiné

	□ cm	↑ cm	ltr.	€
10328 3	Ø 8	10	0,35	6,20
10329 0	Ø 9	11,5	0,6	9,00
10330 6	Ø 10,5	13	0,8	12,60
10331 3	Ø 12	16,5	1,3	17,80
10332 0	Ø 13,5	18	2	24,00



**Mess- / Universalkanne**  
**graduated jug**  
**jarra medidora universal**  
**pichet mesureur universel**



matt poliert, mit Maßskalierung innen  
 satin polished finish, with stamped liter scale inner  
 acabado satinado, con graduación en el interior  
 mat, graduations à l'intérieur

	□ cm	↑ cm	ltr.	€
30054 5	Ø 12	13	1	18,00
30056 9	Ø 13	15	1,5	24,80
30055 2	Ø 14	17	2	31,00

in 2 Größen erhältlich



**Messbecher**  
**graduated jug**  
**jarra graduada**  
**pichet gradué**



außen hochglanzpoliert, innen matt poliert, mit Maßskalierung außen  
 outside mirror polished finish, inside satin polished finish, with stamped liter scale  
 exterior pulido brillante, interior satinado con escalado en litros  
 extérieur brillant, intérieur satiné, graduation en litres

	□ cm	↑ cm	ltr.	€
30044 6	Ø 8	11,5	0,5	8,60
30045 3	Ø 10	14	1	11,80



**Milch-Zucker Set**  
**sugar-creamer-set**  
**set para azúcar y leche**  
**plateau avec sucrier et crémier**



hochglanzpoliert, Sahnegießer, Zuckerdose, inkl. Löffel  
 mirror polished finish, milk jug, sugar bowl, incl. spoon  
 pulido brillante, con jarrita de leche, azucarero y cuchara  
 brillant, avec crémier, sucrier et cuillère

	☐ cm	↑ cm		€
00635 5	15 x 11	6,5		17,00



10316  
Zuckerspender

10317  
Milchkännchen

**Zuckerspender / Milchkännchen**  
**sugar pourer / milk jug**  
**dispensador de azúcar**  
**sucrier doseur**



matt poliert  
 satin polished finish  
 pulido efecto satinado  
 intérieur et extérieur poli mat

	☐ cm	↑ cm	ltr.	€
10316 0	Ø 5	15	0,17	8,60
10317 7	Ø 5	11,5	0,17	6,00



**Milchkännchen, 4er Set**  
**milk/cream jugs, 4 pcs. set**  
**pack de 4 jarritas para leche o crema**  
**pack de 4 crémiers**



hochglanzpoliert, für Kaffeesahne, mit Griff, Inhalt à 25 ml  
 mirror polished finish, for coffee-cream, with handle, capacity à 25 ml  
 pulido brillante, para crema de café, con asa, capacidad 25 ml  
 brillant, avec anse, 25 ml

	☐ cm	↑ cm	pcs.	€
10321 4	Ø 3,6	3,5	4	12,90



10318  
in 3 Größen  
erhältlich

**Milchkännchen / Sahnegießer**  
**milk / cream jug**  
**jarra de leche/ crema**  
**pichet à eau ou lait**



hochglanzpoliert / mirror polished finish / pulido brillante / brillant

	☐ cm	↑ cm	ltr.	€
10318 4	Ø 4	4	0,05	2,00
10319 1	Ø 4,8	5	0,09	2,40
10320 7	Ø 6	6	0,15	3,00



**Zucker-Kugel**  
sugar pot  
azucarero  
sucrier



hochglanzpoliert, mit Rolldeckel, Lieferung ohne Deko  
mirror polished finish, rolltop cover  
pulido acabado brillante, tapa abatible, se entrega sin decoración  
brillant, couvercle abattant, livré sans décoration

	□ cm	↑ cm	€
00033 9	Ø 13,5	15	10,90

für ca. 15 Zuckertüten



**Zuckertüten-Box**  
sugar pocket holder  
azucarero para bolsitas  
porte-sachetsw de sucre



matt poliert, für ca. 15 Zuckertüten, Lieferung ohne Deko  
satin polished finish, for ca. 15 sugar packets  
acabado pulido efecto satinado, capacidad 15 sobrecillos, se entrega sin decoración  
poli mat, pour 15 sachets, livré sans décoration

	□ cm	↑ cm	€
11579 8	9 x 7,5	5	7,50



**Portionsspender**  
dispenser  
dispensador para servicio bebidas calientes  
présentoir pour station café



matt poliert, Spender für Milchportionen, Zuckertüten und Rührer, möbelschonende Unterseite, Lieferung ohne Deko

dispenser for condensed milk, sugar packs and stirrers, non-scratching undersurface  
dispensador para leche condensada, sobres de azúcar, agitadores, base antiralladuras, se entrega sin decoración

idéal pour monodoses de crème ou lait, sucre en sachets longs, agitateurs, base revêtue anti-rayures, livré sans décoration

	□ cm	↑ cm	€
00073 5	Ø 11	17,5	22,00



**Milchportionsspender**  
milk dispenser  
dispensador de monodoses de leche  
présentoir pour monodoses de lait ou crème



matt poliert, für ca. 40 Milchportionen, Lieferung ohne Deko

satin polished finish, for approx. 40 points

pulido efecto satinado, para aproximadamente 40 dosis, se entrega sin decoración

poli mat, pour environ 40 monodoses, livré sans décoration

	□ cm	↑ cm	€
00059 9	18 x 10	24	19,90

in 5 Größen erhältlich



**Kaffeekanne**  
**coffee pot**  
**cafetera**  
**pichet à café**



hochglanzpoliert, mit Klappdeckel  
 mirror polished finish, with hinged cover  
 acabado brillante, tapa con bisagra  
 poli brillant, couvercle à charnière

	cm	cm	litr.	€
10323 8	Ø 8	11,5	0,35	8,00
10322 1	Ø 9	14	0,6	10,50
10325 2	Ø 10,5	15,5	0,9	15,00
10326 9	Ø 12	18,5	1,5	21,00
10327 6	Ø 13,5	20	2	26,50

designed by **CULTURE FORM**



30126 + 30127  
 mattiert



30136 + 30137  
 hochglanzpoliert

**Serviertablett „KAFFEEHAUS“**  
**tray**  
**bandeja**  
**plateau**



	cm		€
30126 9	25,5 x 19,5	mattiert / satin polished finish acabado efecto satinado / fini mat effet satin	6,30
30127 6	30 x 23	mattiert / satin polished finish acabado efecto satinado / fini mat effet satin	8,50
30136 8	25,5 x 19,5	hochglanzpoliert / mirror polished finish acabado espejo pulido / poli brillant miroir	6,30
30137 5	30 x 23	hochglanzpoliert / mirror polished finish acabado espejo pulido / poli brillant miroir	8,50

**Serviertablett „KAFFEEHAUS“**  
**tray**  
**bandeja**  
**plateau**



matt poliert, oval, Rand eingerollt  
 satin polished finish, oval, rolled edge  
 pulido acabado efecto satinado, oval, borde redondeado  
 effet satin, ovale, bord rond



**matt poliert / satin polished**

	cm		€
30111 5	19 x 15	für Zucker und Sahne / for sugar and cream para azúcar y crema / pour le sucre et la crème	4,30
30112 2	26,5 x 19	für eine Tasse / for one cup para una taza / pour une tasse	6,50
30113 9	29 x 22	für zwei Tassen / for two cups para dos tazas / pour deux tasses	6,90
30123 8	23 x 17,5	Eisdielen-Größe / icecream pralor size tamaño especial para heladerías / taille spéciale pour glaciers	6,10

hochglanzpoliert, oval, Rand eingerollt  
 mirror polished finish, oval, rolled edge  
 pulido efecto espejo, ovalado, borde redondeado  
 effet brillant, ovale, bord rond



**hochglanzpoliert / mirror polished**

30115 3	19 x 15	für Zucker und Sahne / for sugar and cream para azúcar y crema / pour le sucre et la crème	4,30
30116 0	26,5 x 19	für eine Tasse / for one cup para una taza / pour une tasse	6,50
30117 7	29 x 22	für zwei Tassen / for two cups para dos tazas / pour deux tasses	6,90
30124 5	23 x 17,5	Eisdielen-Größe / icecream pralor size tamaño especial para heladerías / taille spéciale pour glaciers	6,10





60551 - silber/grau

**Servietten- und Bestecktaschen, 6er Set**  
**cutlery bag, 6 pcs.**  
**bolsa cubiertos, 6 pz.**  
**pochette couverts, 6 pc.**



	cm		VE / Unit	€
60550 3	24 x 9	beige/beige	6	3,90
60551 0	24 x 9	silbergrau/silbergrey	6	3,90
60552 7	24 x 9	beige braun/beige brown	6	3,90
60553 4	24 x 9	apfelgrün/applegreen	6	3,90
60554 1	24 x 9	platin/platinum	6	3,90



60552 - beige/braun



60550 - beige

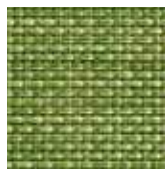

60553 - apfelgrün

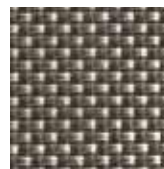

60554 - platin



**Serviettenringe, 6er Set**  
**napkin rings, 6 pcs. set**  
**servilleteros, set de 6**  
**anneaux à serviettes, set de 6**



	cm	↑ cm	pcs.	€
04445 6	6,5 x 4,5	1	6	22,40



**Serviettenringe, 4er Set**  
**napkin rings, 4 pcs. set**  
**servilleteros, set de 4**  
**anneaux porte-serviette, set de 4**



hochglanzpoliert  
 mirror polished finish  
 acero inoxidable  
 inox

	cm	↑ cm	pcs.	€
04446 3	Ø 4,5	2,5	4	6,40



**Messerbänkchen, 6er Set**  
**knife rest, 6 pcs. set**  
**reposa cuchillos, set de 6**  
**repose-couteaux, set de 6**



	cm	↑ cm	pcs.	€
04447 0	8 x 3	1,5	6	21,90



EAN = 40 04 133 XXXXX X

**NEW**

Deckel bleibt  
offen stehen



**inklusive Löffel**  
**inclusive spoon**

**Teebox / Multibox**  
**tea caddy**  
**caja para té**  
**boîte à thés et infusions**



3 Fächer, aufklappbarer Deckel, mit Löffel  
3 chambers, incl. spoon  
3 compartimentos, incl. cuchara  
3 compartiments, incl. cuillère

	cm	cm	€
11566 8	26 x 10	11	14,00

Deckel bleibt  
offen stehen



**Teebox / Multibox**  
**tea caddy**  
**caja para té**  
**boîte à thés et infusions**



3 Fächer für kuvertierte Teebeutel, 1 Fach für Zucker, Kekse, etc., Deckel aufklappbar  
4 chambers  
4 compartimentos  
4 compartiments

	cm	cm	€
11563 7	22 x 17	9	17,00

Deckel bleibt  
offen stehen



11575



11574

**Teebox**  
**tea-box**  
**caja para té**  
**boîte à thés et infusions**



Holzbox mit Sichtfenster, mit Aufschrift „Tee“, 4 Kammern können mit je 30 kuvertierten Teebeuteln bestückt werden, Deckel bleibt offen stehen

wooden box with clear transparent window, with inscription „Tee“, 4 chambers for approx. 30 tea bags

caja de madera clara con ventana transparente, con inscripción „Tee“, 4 compartimentos, para aproximadamente 30 bolsas de té

en bois clair avec fenêtre, marquée „TEE“, 4 compartiments, pour environ 30 sachets

	cm	cm		€
11575 0	33,5 x 20	9	●	17,00
11574 3	33,5 x 20	9	●	17,00
11576 7	33,5 x 20	9	●	ohne Aufschrift / without inscription sin inscripción / sans inscription

Deckel bleibt  
offen stehen



11775



11776

**Teebox**  
**tea-box**  
**caja para té**  
**boîte à thés et infusions**



Holzbox mit Sichtfenster, mit Aufschrift „Tee“, 12 Kammern können mit je 12 kuvertierten Teebeuteln bestückt werden, Deckel bleibt offen stehen

wooden box with clear transparent window, with inscription "Tee", 12 chambers for approx. 144 tea bags

caja de madera clara con ventana transparente, con inscripción „Tee“, 12 compartimentos, para aproximadamente 144 bolsas de té

en bois clair avec fenêtre, marquée „TEE“, 12 compartiments, pour environ 144 sachets

	cm	cm		€
11775 4	31 x 28	9	●	23,00
11776 1	31 x 28	9	●	23,00

designed by EsserDesign



**Schale, 3-geteilt  
bowl, 3-section  
bol, 3 secciones  
bol 3 compartiments**



	□ cm	↑ cm	€
83536 8	17,5 x 7,5	4,5	5,00



**Teebeutel-Halter  
tea bag caddy  
porta bolsitas de té  
présentoir pour sachets de thé**



mit bis zu 15 Teebeuteln bestückbar  
up to max. 15 tea bags  
hasta 15 bolsitas de té  
maxi 15 sachets

	□ cm	↑ cm	€
11577 4	8,5 x 8,5	5	9,90



**Teebeutel-Ablagen, 2er Set  
tea bag rest, 2 pcs. set  
platos para bolsita de té, set de 2  
soucoupes pose-sachet, set de 2**



hochglanzpoliert  
mirror polished finish  
acabado pulido brillante  
brillant

	□ cm	↑ cm	pcs.	€
11578 1	12,5 x 7	1	2	8,70



**Teebrühsieb  
snap mesh tea ball  
infusor de té, pinza con malla  
boule à thé avec pince**



matt poliert, mit feinem Sieb, aufklappbar  
satin polished finish, with fine mesh, hinged  
acabado pulido efecto satinado, con malla fina, con bisagra  
inox mat, maille fine, avec charnière

	□ cm	→ cm	€
74750 0	Ø 4,5	15,5	2,10



**Zitronenschnitzelpresse  
lemon slice squeezer  
pinza exprimelimon  
pince presse-citron**



hochglanzpoliert, zum Auspressen von Zitronenscheiben  
mirror polished finish, to press lemon slices  
pulido brillante, para rodajas de limón  
brillant, pour citrons en rondelle

	□ cm	€
71430 4	8 x 7	1,20



**Serviettenhalter  
napkin holder  
servilletero  
porte-serviettes**



hochglanzpoliert, für Servietten mit 1/8 Falz, FüÙe mit rutsch- und kratzfester Gummierung  
mirror polished finish, for napkins with 1/8 fold, rubber feet  
acabado brillante, para servilletas con plegado 1/8  
brillant, pour serviettes avec pliage 1/8

	▣ cm	↑ cm	€
11720 4	10 x 11,5	18,5	11,60



**Serviettenhalter  
napkin holder  
servilletero  
porte-serviettes**



möbelschonende Unterseite, für ca. 30 Servietten, matt poliert  
non-scratching undersurface, for approx. 30 napkins, satin polished finish  
pie revestido antiralladuras, para aprox. 30 servilletas, acabado mate  
pied revêtu pour ne pas rayer le mobilier, pour environ 30 serviettes, poli mat satiné

	▣ cm	↑ cm	€
11780 8	15 x 4,5	12,5	6,20



**Serviettenhalter  
napkin holder  
servilletero  
porte-serviettes**



möbelschonende Unterseite, für ca. 20 Servietten, matt poliert  
non-scratching undersurface, for approx. 20 napkins, satin polished finish  
pie revestido antiralladuras, para aprox. 20 servilletas, acabado mate  
pied revêtu pour ne pas rayer le mobilier, pour environ 20 serviettes, poli mat satiné

	▣ cm	↑ cm	€
11778 5	17 x 3	7	6,40



**Serviettenhalter  
napkin holder  
servilletero  
porte-serviettes**



möbelschonende Unterseite, für ca. 20 Servietten, hochglanzpoliert  
non-scratching undersurface, for approx. 20 napkins, mirror polished finish  
pie revestido antiralladuras, para aprox. 20 servilletas, acabado pulido brillante  
pied revêtu pour ne pas rayer le mobilier, pour environ 20 serviettes, brillant

	▣ cm	↑ cm	€
11777 8	17 x 3	7	6,40



**Serviettenhalter „PROFI“  
napkin holder, incl. weight  
servilletero  
porte-serviettes**

für 150 Servietten 1/4 Falz, inkl. Beschwerer, mit Antirutschfüßchen, absolut standfest  
for 150 napkins 1/4 fold, anti-slip feet, very stable  
para 150 servilletas de 1/4 plegado  
pour 150 serviettes pliage 1/4

	cm	cm	cm	€
11766 2	18,5 x 18,5	18		35,00



11763



11765

**Serviettenhalter „WIRE“  
napkin holder  
servilletero  
porte-serviettes**



für Servietten 1/4 Falz, inkl. Beschwerer  
incl. pressure bar, with colour inlay  
incluye barra de contrapeso  
barre de contrepoids incluse, acier chromé

	cm	cm		€
11763 1	19 x 19	6,5	für 50 Servietten for 50 napkins para 50 servilletas pour 50 serviettes	5,50
11765 5	19 x 19	19	für 150 Servietten for 150 napkins para 150 servilletas pour 150 serviettes	9,00



**Serviettenhalter „BAR“  
napkin folder  
servilletero  
porte-serviettes**



für ca. 50 Cocktailservietten, inkl. Beschwerer  
for approx. 50 cocktail napkins, incl. weight  
para aprox. 50 servilletas de aperitivo, incluye barra de contrapeso  
pour environ 50 serviettes mini, barre de contrepoids incluse

	cm	cm		€
11762 4	14 x 14	6,5		5,50



**Serviettenhalter  
napkin holder  
servilletero  
porte-serviettes**



matt poliert  
satin polished finish  
acabado satinado  
mat satiné

	cm	cm		€
11730 3	17 x 17	5		16,80

designed by **CULTURE FORM**



**Tisch Set „VARIO I“**  
**table set**  
**set de mesa**  
**set de table**



4-teilig: 1 Ständer + 1 Behälter (innen Ø 7 cm) für Tischreste + 2 Behälter (innen Ø 9 cm) für Besteck, Servietten etc., vielseitig einsetzbar

4 pcs. set: 1 stand + 1 table garbage bin (inner Ø 7 cm) + 2 bins (inner Ø 9 cm) for cutlery, napkins etc., versatile applicable

4 piezas: 1 soporte + 1 papelera Ø 7 cm de sobremesa + 2 recipientes Ø 9 cm para cubiertos, servilletas etc.

4 éléments: 1 support + 1 poubelle de table Ø 7 cm + 2 récipients Ø 9 cm pour couverts, serviettes, etc.

	□ cm	↑ cm	€
11925 3	22 x 22	26	64,00

**Einzelteile / spare parts / piezas sueltas / pièces détachées**

Einzel-Behälter / only container / sólo contenedor / récipient seul

83998 4	Ø 13 / 7	14	11,50
---------	----------	----	-------

Einzel-Behälter / only container / sólo contenedor / récipient seul

83999 1	Ø 13 / 9	14	11,50
---------	----------	----	-------

designed by **CULTURE FORM**



**Tisch Set „VARIO II“**  
**table set**  
**set de mesa**  
**set de table**



4-teilig: 1 Ständer + 3 Behälter (innen Ø 9 cm) für Besteck, Servietten etc., vielseitig einsetzbar

4 pcs. set: 1 stand + 3 bins (inner Ø 9 cm) for cutlery, napkins etc., versatile applicable

4 piezas: 1 soporte + 3 recipientes Ø 9 cm para cubiertos, servilletas etc.

4 pièces: 1 support, 3 récipients Ø 9 cm, pour couverts, serviettes, ...

	□ cm	↑ cm	€
11927 7	22 x 22	26	64,00

**Einzelteile / spare parts / piezas sueltas / pièces détachées**

Einzel-Behälter / only container / sólo contenedor / récipient seul

83998 4	Ø 13 / 7	14	11,50
---------	----------	----	-------

Einzel-Behälter / only container / sólo contenedor / récipient seul

83999 1	Ø 13 / 9	14	11,50
---------	----------	----	-------



83998



83999

designed by **CULTURE FORM**



**Tischreste- / Besteckbehälter „TOP CHROM“**  
**table waste bin / cutlery bin**  
**papelera de sobremesa / recipiente para cubiertos**  
**poubelle de table / récipients pour couverts**



mit verchromten Rand  
 with chrome plated ring  
 con anillo cromado  
 avec bord chromé

	□ cm	↑ cm	ltr.		€
00025 4	Ø 13	15	1	○	6,00
00026 1	Ø 13	15	1	●	6,00

designed by **CULTURE FORM**



**Tischreste- / Besteckbehälter „BASE CHROM“**  
**table waste bin / cutlery bin**  
**papelera de sobremesa / recipiente para cubiertos**  
**poubelle de table / récipients pour couverts**



mit verchromten Boden  
 with chrome bottom  
 con base cromada  
 avec base chromée

	□ cm	↑ cm	ltr.		€
00019 3	Ø 13	15	1,3	○	6,00
00020 9	Ø 13	15	1,3	●	6,00

**Tischrestebehälter**  
**table garbage bin**  
**papelera de sobremesa**  
**poubelle de table**



matt poliert, abnehmbarer Schwingdeckel, mit Bajonettverschluss „fester Deckelsitz“  
 satin polished finish, swing cover, cover removable  
 acabado satinado, tapa basculante desmontable  
 poli mat satiné, couvercle basculant démontable

	□ cm	↑ cm	ltr.		€
00029 2	Ø 12	17	1,2		16,00
00027 8	Ø 10	13	0,7		12,00

**Tischreste- / Besteckbehälter**  
**table garbage bin / cutlery bin**  
**papelera de sobremesa / recipiente para cubiertos**  
**poubelle de table / récipients pour couverts**



matt poliert, mit abnehmbarem Lochdeckel  
 satin polished finish, with removeable cover  
 acabado pulido satinado, con tapa desmontable  
 poli mat satiné, avec couvercle démontable ouvert au centre

	□ cm	↑ cm	ltr.		€
00028 5	Ø 10	12	0,7		12,00

**NEW**

**Table Caddy „COUNTRY STYLE“**  
**table barrel**  
**caddy de mesa**  
**caddy de table**



cooler Country-Style, nicht für den direkten Kontakt mit Lebensmittel verwendbar  
 make for cool condiment and cutlery holders or even for food presentation, the mini barrels should not come into contact with food, they should be lined with our greaseproof paper  
 estilo campo, no aptos para el contacto directo con alimentos, sólo usando papel alimenticio  
 de style champêtre, pas de contact direct avec aliments, seulement en utilisant papier alimentaire



11931

	☐ cm	↑ cm	€
11931 4	Ø 11,5	14,0	22,00
11930 7	Ø 17,5	8,5	22,00



11930

**NEW**

**Tischrestebehälter**  
**table garbage bin**  
**papelera de sobremesa**  
**poubelle de table**



matt poliert, abnehmbarer Schwingdeckel, mit Bajonettverschluss „fester Deckelsitz“  
 satin polished finish, swing cover, cover removable  
 acabado satinado, tapa basculante desmontable  
 poli mat satiné, couvercle basculant démontable



	☐ cm	↑ cm	ltr.	€
00053 7	Ø 14	20	2,0	19,00





designed by **KIRCHHOFF & EUWENS**



**Tischrestebehälter „SUNDAY“**  
**table waste bin**  
**papelera de sobremesa**  
**poubelle de table**



matt poliert, inkl. Deckel, fester Deckelsitz  
 satin polished finish, incl. cover, cover removeable  
 acero inoxidable mate, con tapa  
 inox mat, avec couvercle

	cm	cm	litr.	€
00024 7	Ø 10	18	1,1	23,00



**Tischrestebehälter**  
**table garbage bin**  
**papelera de sobremesa**  
**poubelle de table**



Behälter aus weiß lackiertem Metall, Edelstahl-Lochdeckel  
 metall white, stainless cover with hole  
 tapa, acero inoxidable, con apertura  
 couvercle inox, avec ouverture centrale, récipient en acier laqué blanc

	cm	cm	litr.	€
00292 0	Ø 12	15	1,2	13,20



**Tischrestebehälter**  
**table garbage bin**  
**papelera de sobremesa**  
**poubelle de table**



Behälter aus weiß lackiertem Metall, abnehmbarer Schwingdeckel  
 cover stainless steel bin metal, white, swing cover  
 tapa de acero inoxidable, recipiente chapa lacada blanca  
 couvercle inox basculant, récipient en acier laqué blanc

	cm	cm	litr.	€
00291 3	Ø 12	17	1,2	13,20

designed by **KIRCHHOFF & EUWENS**



**Tischrestebehälter „INTERNATIONAL“**  
**table waste bin**  
**papelera de sobremesa**  
**poubelle de table**



Deckel-Ring mit Dichtung, internationale Beschriftung  
 cover with sealing ring  
 tapa con junta, texto multi-idomas  
 couvercle avec joint, texte multilingue

	cm	cm	litr.	€
83847 5	10	17,5	1	9,00

designed by **CULTURE FORM**



**Tischreste- / Besteckbehälter / Universalbox**  
**table waste bin / cutlery bin / box**  
**papelera de sobremesa / recipiente para cubiertos**  
**poubelle de table / récipients pour couverts**



mit verchromten Rand  
 with chrome plated ring  
 con anillo cromado  
 avec bord chromé

	cm	cm		€
00015 5	13,5 x 13,5	11	●	16,00
00215 9	13,5 x 13,5	11	○	16,00



**Tischreste- / Besteckbehälter / Universalbox**  
**table waste bin / cutlery bin / box**  
**papelera de sobremesa / recipiente para cubiertos**  
**poubelle de table / récipients pour couverts**



mit verchromten Rand, inkl. herausnehmbarem Einteiler (4 Fächer)  
 with chrome plated ring, incl. divider (4 chambers)  
 con anillo cromado  
 avec bord chromé

	cm	cm		€
00016 2	14 x 14	16	●	18,40
00216 6	14 x 14	16	○	18,40

mit Antirutsch-Füßchen  
 non-slip feet  
 con pies antideslizantes  
 avec pieds antidérapants



**stapelbar**  
**stackable**  
**apilables**  
**empilable**

designed by **EsserDesign**



**Behälter**  
**stand**  
**recipiente organizador**  
**récipient de table**



	cm	cm	€
83537 5	10 x 4	6,5	3,00



**Schale, 2-geteilt**  
**bowl, 2-section**  
**bol, 2 secciones**  
**bol 2 compartiments**



	cm	cm	€
83538 2	17,5 x 7,5	4,5	5,00



**Schale, 3-geteilt**  
**bowl, 3-section**  
**bol, 3 secciones**  
**bol 3 compartiments**



	cm	cm	€
83536 8	17,5 x 7,5	4,5	5,00



**HOT  
PRICE**
**Tischrestebehälter**  
**table garbage bin**  
**papelera de sobremesa**  
**poubelle de table**

	☐ cm	↑ cm	ltr.	€
00311 8	Ø 14	15	1,2	3,60
02038 2	Ø 11	14	0,9	3,00

02038

00311

**HOT  
PRICE**

mit Beschriftung

**Tischrestebehälter**  
**table garbage bin**  
**papelera de sobremesa**  
**poubelle de table**

Kunststoff weiß / Granit, abnehmbarer Schwingdeckel  
 white plastic, swing cover, cover removable  
 plástico blanco/granito, tapa basculante desmontable  
 plastique blanc/gris chiné, couvercle basculant démontable

	☐ cm	↑ cm	ltr.	€
00031 5	Ø 12	18	1,4	5,40

**Tischkrümel-Entferner**  
**crumber**  
**recogemigas**  
**ramasse-miettes**

matt poliert, Hohlgriff  
 satin polished finish, hollow handles  
 acabado mate, fácil de usar, mango hueco  
 mat satiné, manche creux, simple à utiliser

	☐ cm	→ cm	€
00058 2	6,5 x 2,5	22	14,00

**Tischkrümel-Entferner**  
**crumber**  
**recogemigas**  
**ramasse-miettes**

matt poliert, geschliffene Edelstahlkante lässt kein Körnchen zurück  
 satin polished finish, no grain remains thanks to the flat grinded stainless steel edge  
 acabado pulido mate, las migas se recogen fácilmente del mantel sin dejar restos gracias a su borde afilado  
 mat satiné, ramasse facilement les miettes sur la nappe sans rien laisser grâce au rebord affilé

	☐ cm	↑ cm	€
00581 5	19 x 4,5	1	7,20

**NEW**



10921 - 0,3 ltr.



10922 - 0,6 ltr.



10923 - 1,0 ltr.



10924 - 1,5 ltr.

**Isolierkanne "ADVANCED"  
vacuum jug  
jarra termo  
bouteille isotherme**



doppelwandig, spülmaschinenfest, Einhandautomatik, aufgeklappt passt die Kanne unter die gängigen Kaffeemaschinen, Höhe mit geöffneter Klappe = 18 cm, für heiße und kalte Getränke  
double-walled, dishwasher-safe, easy pouring system, with flipped-back lid, the air pot fits under a wide range of coffee makers, height with flipped-back lid = 18 cm for hot and cold beverages

doble pared, resistente al lavavajillas, se maneja con 1 mano, con la tapa abierta la jarra se puede usar con casi todas las cafeteras corrientes, altura de la jarra con la tapa abierta = 18 cm, para bebidas frías y calientes

double paroi, résistante au lave-vaisselle, usage à 1 main, avec la couvercle ouverte la bouteille se peut user avec toutes les machines à café courantes, hauteur de la bouteille avec couvercle ouverte = 18 cm, pour boissons chaudes ou froides

	□ cm	↑ cm	ltr.	Anzahl Tassen	€
10921 6	Ø 10,5	13	0,3	2,5	33,00
10922 3	Ø 10,5	18	0,6	5	39,00
10923 0	Ø 13,0	19,5	1,0	8	42,50
10924 7	Ø 13,0	23,5	1,5	12	47,00

**Deckel bleibt stehen**



**tropffreies Ausgießen durch Tastendruck**

**NEW**



10910 - 1,0 ltr.



10911 - 1,5 ltr.



10912 - 2,0 ltr.

**tropffreies Ausgießen durch Tastendruck**



**Isolierkanne "CLASSIC"**  
vacuum jug  
jarra termo  
bouteille isotherme



doppelwandig, Einhandautomatik, Drehverschluss, für heiße und kalte Getränke  
double-walled, easy push-button pouring system, screw cap, for hot and cold drinks  
doble pared, se maneja con 1 mano, con tapa a rosca, para bebidas frías y calientes  
double paroi, usage à 1 main, couvercle à visser, pour boissons chaudes ou froides

	□ cm	↑ cm	ltr.	Anzahl Tassen	€
10910 0	Ø 14	19	1,0	8	16,20
10911 7	Ø 14	22	1,5	12	20,00
10912 4	Ø 14	25	2,0	16	23,00

**NEW**



10913 - 1,0 ltr.



10914 - 1,0 ltr.

**Isolierkanne "ECONOMY"**  
vacuum jug  
jarra termo  
bouteille isotherme



robuste Umhüllung mit Polypropylen-Kunststoff, Stabilglaseinsatz, Drehverschluss mit Drucktasten-Bedienung für heiße und kalte Getränke  
double-walled with glass liner, screw cap with easy push-button pouring system, for hot and cold beverages  
exterior de plástico polipropileno, interior aislante de vidrio, con tapa a rosca con cierre dosificador para bebidas frías y calientes  
extérieur en plastique polypropylène, intérieur avec plaque de verre, couvercle à visser, pour boissons chaudes ou froides

	□ cm	↑ cm	ltr.	Anzahl Tassen	€
10913 1	Ø 16	20	1,0	8	13,60
10914 8	Ø 16	20	1,0	8	13,60

**tropffreies Ausgießen durch Tastendruck**



**NEW**

Inhaltsbeschriftung



Füllstandsanzeige  
fill level indicator



hochwertiger Pumphebel  
quality pump lever



herausnehmbare Pumpeinheit  
removable pumping unit

**Pump-Isolierkanne "PREMIUM"**  
air pot  
jarra termo  
bouteille isotherme



doppelwandig, Tragegriff, drehbarer Fuß, Pumpmechanismus und Füllstandsanzeige sind leicht zu reinigen mit 4 unterschiedlichen Inhaltsbeschriftungen für den Pumphebel (coffee, tea, hot water, decaf), aufgeklappt passt die Kanne unter die gängigen Kaffeeautomaten, für heiße und kalte Getränke

double-walled, carrying handle, pivotable feet, pump mechanism and fill level indicator is easily removable for cleaning, includes 4 different beverage signs (coffee, tea, hot water, decaf), with flipped-back lid, the air pot fits under a wide range of coffee makers, for hot and cold beverages

doble pared, con asa al lateral, pié girable, el mecanismo a presión y el indicador óptico del nivel son fácil de limpiar, con 4 etiquetas diferentes para la palanca (coffee, tea, hot water, decaf), con la tapa abierta la jarra se puede usar con casi todas las cafeteras corrientes, para bebidas frías y calientes

double paroi, avec poignée, pied pivotant, le mécanisme a pression et l'indicateur de niveau sont facile à retirer pour le nettoyage, avec 4 étiquettes différents pour la pompe (coffee, tea, hot water, decaf), avec la couvercle ouverte la bouteille se peut user avec toutes les machines à café courantes, pour boissons chaudes ou froides

	cm	cm	ltr.	Anzahl Tassen	€
10916 2	Ø 15	37,0	3,0	24	60,00

**Einzelteile / spare parts / piezas sueltas / pièces détachées**

Tropfenfänger für Pump-Isolierkanne / drip tray for air pot / recoge gotas para jarra termo / ramasse-gouttes pour bouteilles isotherme

	cm	cm		€
10917 9	24,0 x 18,5	4	●	9,40



10917  
Tropfenfänger für  
Pump-Isolierkanne

**NEW**



Dreh-Pumpknopf  
rotatable  
Push-Button



einfacher Pumpmechanismus  
easy pump mechanism

**Pump-Isolierkanne "BUDGET"**  
air pot  
jarra termo  
bouteille isotherme



doppelwandig, Tragegriff, drehbarer Fuß, Dreh-Pumpknopf zur leichten Bedienung (close/open), Pumpmechanismus ist leicht zu entnehmen und zu reinigen, aufgeklappt passt die Kanne unter die gängigen Kaffeeautomaten, für heiße und kalte Getränke

double-walled, carrying handle, pivotable feet, rotatable Push-Button for easy use (close/open), pump mechanism is easily removable for cleaning, with flipped-back lid, the air pot fits under a wide range of coffee makers, for hot and cold beverages

doble pared, con asa al lateral, pié girable, tapa girable y a presión para uso fácil (close/open), el mecanismo a presión es fácil de retirar para limpiar, con la tapa abierta la jarra se puede usar con casi todas las cafeteras corrientes, para bebidas frías y calientes

double paroi, avec poignée, pied pivotant, couvercle à visser et a pression pour facile usage (close/open), le mécanisme a pression est facile à retirer pour le nettoyage, avec la couvercle ouverte la bouteille se peut user avec toutes les machines à café courantes, pour boissons chaudes ou froides

	cm	cm	ltr.	Anzahl Tassen	€
10915 5	Ø 13,5	32,5	2,2	17	29,00



Original Turk-Qualität



**schmiedeeiserne Servierpfanne**  
**wrought-iron pan**  
**sartén forjada**  
**poêle à friré forgée**



mit zwei Griffen, hervorragende Brateigenschaft, Griffe und Stiele angeschweißt  
with two welded handles, best bake properties, professional quality  
con dos asas, excelentes propiedades de cocción, calidad profesional  
2 anses, qualité professionnelle, excellente diffusion de chaleur, idéale pour la cuisson

	☐ cm	↑ cm	📦 kg	€
73700 6	Ø 14 - 20	3	0,87	16,80
73701 3	Ø 17 - 24	3	1,15	19,30
73702 0	Ø 21 - 28	3,5	1,49	27,30
73703 7	Ø 24 - 32	3,5	1,85	41,90

Original Turk-Qualität



**schmiedeeiserne Servierpfanne**  
**wrought-iron pan**  
**sartén forjada**  
**poêle à friré forgée**



mit geschmiedetem, angeschweißtem Hakenstiel, hervorragende Brateigenschaft  
welded handle with hook, best bake properties, professional quality  
mango soldado, con gancho al final, excelentes propiedades culinarias, calidad profesional  
manche soudé à accrocher, qualité professionnelle, excellente diffusion de chaleur, idéale pour la cuisson sur tous feux, pour le four ou pour la table

	☐ cm	↑ cm	📦 kg	€
73710 5	Ø 11 - 16	2	0,56	11,60
73711 2	Ø 14 - 20	3	0,85	15,10
73712 9	Ø 17 - 24	3	1,17	17,90
73713 6	Ø 21 - 28	3	1,53	25,20
73714 3	Ø 24 - 32	3	1,99	37,80
73719 8	Ø 21 - 28	4,5	1,72	extra hoher Rand 39,70

Original Turk-Qualität



**schmiedeeiserne Servierpfanne**  
**wrought-iron pan**  
**sartén forjada**  
**poêle à friré forgée**



mit geschmiedetem angeschweißtem gebogenem Hakenstiel, hervorragende Brateigenschaft  
welded bended handle with hook, best bake properties, professional quality  
con mango vuelto soldado, excelentes propiedades, calidad profesional  
manche soudé replié, qualité professionnelle, excellente diffusion de chaleur

	☐ cm	↑ cm	📦 kg	€
73725 9	Ø 14 - 20	3	0,87	15,70
73726 6	Ø 17 - 24	3	1,18	19,70
73727 3	Ø 21 - 28	3	1,54	27,30



**Korkuntersetzer**  
**cork mat**  
**salvamanteles**  
**dessous-de-plat liège**



ideal für Servier- und Eisenpfannen  
ideal for iron pan  
ideal para servir en sartenes de chapa  
idéal pour présenter les poêles forgées sur table

	☐ cm	↑ cm	€
73750 1	Ø 24	2	11,00



Original Turk-Qualität



**Eisenpfanne**  
**iron pan**  
**sartén de chapa**  
**poêle à frire lyonnaise**



schwere Ausführung, mit angeschweißtem flachem Hakenstiel mit Öse, extra hoher Rand, für den professionellen Einsatz

heavy version, with flat welded handle with eye, extra high seam, professional quality

pesada, con mango plano, borde alto, para uso profesional

qualité lourde, manche plat, bord haut, pour usage professionnel



	□ cm	↑ cm	⬆ kg	€
73739 6	Ø 14,5 - 20	4	1,04	14,10
73740 2	Ø 17 - 24	4	1,45	17,60
73741 9	Ø 20,5 - 28	4,5	1,87	24,20
73742 6	Ø 23 - 32	5	2,41	29,10
73743 3	Ø 27 - 36	6	3,11	37,80
73744 0	Ø 31 - 40	6	3,73	45,20

Original Turk-Qualität



**Pizzaform**  
**pizza dish**  
**molde de pizza**  
**moule à pizza**



Blaublech, nicht beschichtet, lange Lebensdauer, zum professionellen Pizzabacken

metal sheet, without coating, long endurance, baking pizza professional

chapa azul, sin revestimiento, muy resistente, para uso profesional, larga duración

métal, sans revêtement, très résistant, pour usage professionnel, très durable



hitzebeständig bis 600°C

	□ cm	↑ cm	€
73500 2	Ø 14 - 12,3	2,5	2,20
73501 9	Ø 16 - 14,2	2,5	2,40
73502 6	Ø 18 - 16,2	2,5	2,60
73503 3	Ø 20 - 18,2	2,5	2,80
73504 0	Ø 22 - 20,2	2,5	3,10
73505 7	Ø 24 - 22,3	2,5	3,40
73506 4	Ø 26 - 24,3	2,5	3,60
73507 1	Ø 28 - 26,3	2,5	4,00
73508 8	Ø 30 - 28,3	2,5	4,60
73509 5	Ø 32 - 30,3	2,5	5,00
73510 1	Ø 36 - 34,3	2,5	5,90
73511 8	Ø 40 - 38,3	2,5	8,30
73512 5	Ø 45 - 42,3	2,5	10,50
73513 2	Ø 50 - 48,4	2,5	12,70

**Pizzaform**  
**pizza dish**  
**molde de pizza**  
**moule à pizza**



Blaublech, rechteckig, Rand umgelegt, hitzebeständig bis 260°C

blue steel baking sheet, rectangular

chapa azul rectangular, borde plgado

métal, rectangulaire, bord plié



hitzebeständig bis 260°C

	□ cm	↑ cm	€
88255 3	50 x 35	2,5	14,50
88256 0	60 x 40	2,5	19,80



**Back- / Frittierlöffel  
skimmer / spider  
espumadera para fritos  
écumoire à friture**

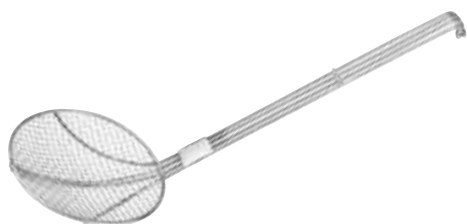

elektropoliert, sehr stabile Ausführung  
electro polished, heavy gauge  
electro pulido, alta calidad  
poli électrolythique, qualité extra

	☐ cm	→ cm	€
74400 4	Ø 10	32,5	7,50
74401 1	Ø 12	43,5	14,00
74402 8	Ø 16	42,5	17,00
74403 5	Ø 18	42,5	19,00
74404 2	Ø 20	51	21,00



**Gazespitzsieb  
conical strainer with wire gauze  
colador chino de malla  
chinois renforcé avec maille fine**



hochglanzpoliert, mit rundem Hohlgriff, ca. 9 Löcher pro 1 cm<sup>2</sup>  
mirror polished finish, 9 holes per 1 cm<sup>2</sup>  
pulido acabado brillante, mango hueco, 9 agujeros por 1 cm<sup>2</sup>  
brillant, manche creux, 9 trous pour 1 cm<sup>2</sup>

	☐ cm	→ cm	€
88718 3	Ø 20	25	35,30
88717 6	Ø 24	25	42,60



**Spitzsieb  
conical strainer  
colador cónico  
chinois**



mit Lochung Ø 1,5 mm, auch in der Kegelspitze, mit Flachstiel, mit Stützstiel zum Einhängen in den Topfrand  
with Ø 1,5 mm holes (including the tip), with flat handle, with supporting hook  
con agujeros finos de Ø 1,5 mm (incluída la punta), con mango plano y gancho  
perforations fines 1,5 y compris à la pointe, manche plat et crochet

	☐ cm	↑ cm	→ cm	€
00770 3	Ø 19,5 / 18	14	16	18,90
00771 0	Ø 23,5 / 22	18	16	22,40



**Likör- und Fondanttrichter  
confectionery funnel  
embudo dosificador  
entonnoir à piston**



ergonomischer Griff aus Kunststoff, mit 3 Düsen 2, 4 und 6 mm, inkl. Ständer und Auffangschale  
ergonomic plastic handle, with 3 different nozzles 2, 4 and 6 mm, incl. wire rack and dripping dash  
mango ergonómico de plástico con 3 boquillas, 2, 4 y 6 mm, incluido pie de alambre y bandeja recoge gotas  
manche plastique ergonomique, 3 douilles de 2, 4 et 6 mm, inclut pied avec ramasse-gouttes

	☐ cm	↑ cm	ltr.	€
77338 7	Ø 20	34	1,5	88,00

**Passiersieb  
strainer  
colador  
passoire**



feines Siebgewebe mit ca. 6 Löchern pro 1 cm<sup>2</sup>  
fine mesh with 6 holes per 1 cm<sup>2</sup>  
malla fina con 6 agujeros por 1 cm<sup>2</sup>  
toile fine avec 6 trous pour 1 cm<sup>2</sup>



	□ cm	↑ cm	→ cm	€
88617 9	Ø 26	12	28	44,00
88618 6	Ø 30	12	28	54,00

**Passiersieb  
strainer  
colador  
passoire**



feines Siebgewebe mit ca. 6 Löchern pro 1 cm<sup>2</sup>  
fine mesh with 6 holes per 1 cm<sup>2</sup>  
malla fina con 6 agujeros por 1 cm<sup>2</sup>  
toile fine avec 6 trous pour 1 cm<sup>2</sup>



	□ cm	→ cm	ltr.	€
74698 5	Ø 10	14,5	0,15	5,00
74699 2	Ø 12	14,5	0,25	5,60
74700 5	Ø 14	16	0,4	7,40
74701 2	Ø 16	16	0,7	9,50
74702 9	Ø 18	16	1	12,80
74703 6	Ø 20	16	1,5	14,00
74704 3	Ø 22	17	2,0	15,00
74705 0	Ø 24	17	2,5	16,00
74706 7	Ø 26	17	3,0	19,00

**Passiersieb  
strainer  
colador  
passoire**



**Doppelnetz  
double mesh**



mit Doppelnetz, Netz außen: ca. 2 Löcher pro 1 cm, Netz innen: ca. 5 Löcher pro 1 cm, Netz außen: ca. 2 Löcher pro 1 cm, Netz innen: ca. 5 Löcher pro 1 cm  
with double mesh, outer mesh about 2 holes per cm, inner mesh about 5 holes per cm  
con malla doble, malla exterior aprox. 2 agujeros /cm, interior aprox. 5 agujeros /cm  
avec double étamine, extérieure env. 2 trous/cm, intérieure environ 5 trous/cm

	□ cm	→ cm	€
74721 0	20	18	13,00
74722 7	23	27,5	20,00

**Pommes-Frites-Seiher  
fry dripping tray  
escurridor de fritos  
égouttoir à friture**



herausnehmbarer Locheinsatz, mit Handgriff  
removable drainer, with handle  
fondo de colador desmontable, con asa  
fond démontable, avec poignée

	□ cm	↑ cm	€
00785 7	Ø 39	19	28,00



**Passiermühle  
moulin / sieve  
molino de grosellas  
presse-groseilles**



Rolle Buchen-Holz versiegelt, ca. 10 Löcher pro 1 cm<sup>2</sup>  
wood-piece beech, 10 holes per 1 cm<sup>2</sup>  
bola ovalada de haya, 10 agujeros por 1 cm<sup>2</sup>  
boule ovale en hêtre, 10 trous pour 1 cm<sup>2</sup>

	☐ cm	↑ cm	→ cm	€
88607 0	Ø 20	10	19	20,00

**in 3 Größen  
lieferbar**



**Wasserbadsschüssel  
bain marie bailing bowl  
cazo para baño maría  
récipient bain-marie**



hochglanzpoliert, mit Drahtgriff Ø 5 mm  
mirror polished finish, with wire handle Ø 5 mm  
inox pulido brillante, mango varilla Ø 5 mm  
inox brillant, manche fil épaisseur Ø 5 mm

	☐ cm	↑ cm	→ cm	ltr.	€
74731 9	Ø 18	9	15	1,5	12,00
für Töpfe Ø 20 - 26 cm / for pots Ø 20 - 26 cm para cacerolas Ø 20 - 26 cm / pour casseroles Ø 20 - 26 cm					
74732 6	Ø 20	10	15	2.0	15,00
für Töpfe Ø 24 - 28 cm / for pots Ø 24 - 28 cm para cacerolas Ø 24 - 28 cm / pour casseroles Ø 24 - 28 cm					
74733 3	Ø 24	12	15	3,5	20,00
für Töpfe Ø 26 - 28 cm / for pots Ø 26 - 28 cm para cacerolas Ø 26 - 28 cm / pour casseroles Ø 26 - 28 cm					

**NEW**



**Stielkasserolle / Serviertopf  
sauté pan / mini sauce pan  
cazo recto bajo  
plat à sauter**



	☐ cm	↑ cm	ltr.	€	
40642 1	Ø 5	3	0,07	Griff: 6 cm / handle: 6 cm asa: 6 cm / poignée: 6 cm	4,40
40643 8	Ø 7	4,5	0,14	Griff: 9 cm / handle: 9 cm asa: 9 cm / poignée: 9 cm	5,00
40644 5	Ø 9	6	0,36	Griff: 9 cm / handle: 9 cm asa: 9 cm / poignée: 9 cm	7,90





**Messbecher**  
**measuring cup**  
**jarra graduada**  
**pichet gradué**



mit geschlossenem Griff, mit geprägter Maßskalierung außen, Liter- und Milli-Liter-Einteilung  
 with handle, with stamped printed liter and ml scale  
 con asa, graduación ml.  
 avec anse, graduation en ml.

	□ cm	↑ cm	ltr.	€
30046 0	Ø 9,5	14	0,5	2,90
30047 7	Ø 12	17	1	3,90
30048 4	Ø 15,5	21	2	6,90
30049 1	Ø 17,5	23,5	3	8,90
30057 6	Ø 20,5	27,5	5	10,50

**in 2**  
**Größen**  
**lieferbar**



**Messbecher**  
**graduated jug**  
**jarra graduada**  
**pichet gradué**



außen hochglanzpoliert, innen matt poliert, mit Maßskalierung außen  
 outside mirror polished finish, inside satin polished finish, with stamped liter scale  
 exterior pulido brillante, interior satinado con escalado en litros  
 extérieur brillant, intérieur satiné, graduation en litres

	□ cm	↑ cm	ltr.	€
30044 6	Ø 8	11,5	0,5	8,60
30045 3	Ø 10	14	1	11,80



**Mess- / Universalkanne**  
**graduated jug**  
**jarra medidora universal**  
**pichet mesureur universel**



matt poliert, mit Maßskalierung innen  
 satin polished finish, with stamped liter scale inner  
 acabado satinado, con graduación en el interior  
 mat, graduations à l'intérieur

	□ cm	↑ cm	ltr.	€
30054 5	Ø 12	13	1	18,00
30056 9	Ø 13	15	1,5	24,80
30055 2	Ø 14	17	2	31,00



**Dressingtopf, doppelwandig**  
**bowl, double wall**  
**salsera alta, doble pared**  
**pot à sauce, double paroi**



beste Isoliereigenschaften  
 best insulating properties  
 muy aislante  
 très isolant

	□ cm	↑ cm	ltr.	€
30043 9	Ø 15	18	1,8	41,00

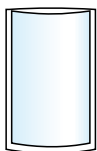

doppelwandig  
 double wall



**Schaumspesering**  
**mousse ring**  
**aro redondo para semifríos**  
**cercle à mousse rond**



matt poliert, fugenlos  
 satin polished finish, seamless  
 acabado satinado sin soldadura  
 mat satiné, sans soudure

	□ cm	↑ cm	€
00098 8	Ø 6	4,5	2,90
00099 5	Ø 7	4,5	3,20
00092 6	Ø 8	4,5	3,40
00093 3	Ø 10	4,5	4,70
00094 0	Ø 12	4,5	6,20
00095 7	Ø 14	5	7,80



**Schaumspesiform**  
**mousse mould**  
**aro cuadrado para semifríos**  
**cercle à mousse carré**



matt poliert, fugenlos  
 satin polished finish, seamless  
 acabado satinado sin soldadura  
 mat satiné, sans soudure

	□ cm	↑ cm	€
00096 4	6 x 6	4,5	6,20
00097 1	8 x 8	4,5	7,90



**Schaumspeseringe, 5er Set**  
**mousse ring, 5 pcs. set**  
**juego aros para emplatar o para semifríos**  
**jeu de cercles à mousse inox, ronds**



5-teilig: 4 Formen + 1 Verdichter, matt poliert, fugenlos  
 5 pcs. set: 4 shapes and 1 pusher, satin polished finish, seamless  
 juego de 5 piezas: 4 aros redondos y 1 pulsador, para dar forma, satinado sin soldadura  
 jeu de 5 pièces: 4 cercles et 1 poussoir. Idéal pour dressage sur assiette ou mousse, mat satiné, sans soudure

	□ cm	↑ cm	€
00110 7	Ø 6	4,5	16,00
00113 8	Ø 8	4,5	17,00
00114 5	Ø 10	4,5	24,20



**Schaumspesiform Herz**  
**mousse mould heart**  
**molde „corazón“ para semifríos**  
**cercle à mousse „coeur“**



matt poliert, fugenlos  
 satin polished finish, seamless  
 acabado satinado sin soldadura  
 mat satiné, sans soudure

	□ cm	↑ cm	€
00116 9	8 x 9	4,5	6,50



**Pastetenform mit Deckel**  
**pastry mould with lid**  
**molde para paté con tapa**  
**moule à terrine avec couvercle**



für Pasteten und Terrinen  
 for pasties and terrines  
 para patés y tarrinas  
 pour pâtés et terrines



**Pastetenform**  
**terrine mould**  
**molde tarrina ángulos rectos**  
**moule à terrine évasé**

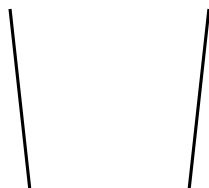

	□ cm	→ cm	ltr.	€
88122 8	7 x 8	30	1,6	32,80

**Pastetenform**  
**terrine mould**  
**molde tarrina redonda**  
**moule à terrine arrondi**

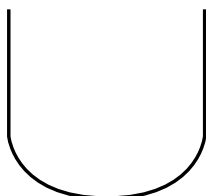

	□ cm	→ cm	ltr.	€
88123 5	5,5 x 5	27,5	0,5	32,80

**Pastetenform**  
**terrine mould**  
**molde tarrina triangular**  
**moule à terrine triangulaire**

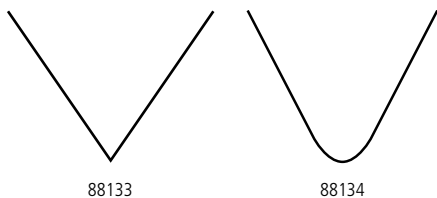

	□ cm	→ cm	ltr.	€
88133 4	8 x 7,5	26	0,7	29,20
88134 1	8 x 7,5	26	0,7	27,90



**200 ml**  
**ideale Größe für**  
**Panna cotta**

**Dariolformen, 2er Set**  
**dariol moulds, 2 pcs. set**  
**juego 2 flaneras**  
**jeu de 2 moules à flan**



hochglanzpoliert  
 mirror polished finish  
 acabado brillante  
 brillant



**in 4 Größen**  
**erhältlich**

	□ cm	↑ cm	ltr.	€
00105 3	Ø 5,6	4,7	0,075	4,20
00106 0	Ø 6,3	4,5	0,1	5,00
00107 7	Ø 7,0	3,5	0,1	5,80
00108 4	Ø 8,5	5,0	0,2	6,40

**NEW**



**Quetschflasche „MINI“, 4er Set  
squeeze bottle, 4 pcs.  
bote dosificador flexible, 4 pz.  
bouteille verseuse souple, 4 pc.**



mit Schraubdeckel und Verschlusskappe, ideal zum Servieren von Dressing und Saucen  
with tight-screw and cap, ideal for serving dressing and sauces  
tapa de rosca, con tapón, ideal para servir aliño y salsas  
bouchon à vis de étanche, avec bouchon, idéal pour servir de vinaigrette et sauces

	□ cm	↑ cm	ltr.	pcs.	€
93225 8	Ø 3,0	8,5	0,03	4	4,00
93226 5	Ø 3,5	9,5	0,05	4	4,40



**200 ml**  
**Quetschflasche  
squeeze bottle  
bote dosificador flexible  
bouteille verseuse souple**



ideale Größe, um Speiseteller mit Saucen zu verzieren, mit Verschlusskappe  
ideal size to garnish plates with sauces, with cap  
tamaño ideal para decorar los platos con salsas o culis, con tapón  
taille idéale pour la décoration sur assiette avec sauces ou coulis, avec bouchon

	□ cm	↑ cm	ltr.	€
93154 1	Ø 5	18	0,2	1,30
93163 3	Ø 5,5	19	0,35	2,10



	□ cm	↑ cm	ltr.		€
93240 1	Ø 7	21	0,35	●	1,80
93241 8	Ø 7	21	0,35	●	1,80
93242 5	Ø 7	21	0,35	○	1,80
93243 2	Ø 8	24,5	0,7	●	2,30
93244 9	Ø 8	24,5	0,7	●	2,30
93245 6	Ø 8	24,5	0,7	○	2,30



**Quetschflasche  
squeeze bottle  
bote dosificador flexible  
bouteille verseuse souple**



mit Verschlusskappe  
with cap  
con tapón  
avec bouchon

	□ cm	↑ cm	ltr.		€
93155 8	Ø 7	24	0,7	●	1,70
93156 5	Ø 7	24	0,7	●	1,70
93157 2	Ø 7	24	0,7	○	1,70





93222  
1,1 ltr.

93223  
1,1 ltr.

93224  
1,1 ltr.

mit Verschlusskappe

**Quetschflasche**  
**squeeze bottle**  
**bote dosificador flexible**  
**bouteille verseuse souple**



	□ cm	↑ cm	ltr.		€
93222 7	Ø 9,5	25,5	1,1	●	5,10
93223 4	Ø 9,5	25,5	1,1	●	5,10
93224 1	Ø 9,5	25,5	1,1	●	5,10



93150  
1,35 ltr.

93151  
1,25 ltr.

88271

**Dosierspender**  
**dispenser**  
**dispensador de salsa**  
**doseur à sauce**



	□ cm	↑ cm	ltr.	€
93150 3	Ø 11	27	1,35	34,70
93151 0	13 x 7,5	27	1,25	34,70

**Dosierpumpe**  
**dosing pump / riser tube**  
**bomba de salsa, sola**  
**pompe à sauce**



Hubvolumen 30 ml / swept volume 30 ml / cada dosis 30 ml / 30 ml par dose

88271 3	Ø 4,5	40	10,00
---------	-------	----	-------



4 - 8 - 14  
Liter / liters

**Schüssel**  
**bowl**  
**ensaladera**  
**saladier**



	□ cm	↑ cm	ltr.		€
30260 0	Ø 32,5	10	4	○	4,70
30263 1	Ø 40	12	8	○	9,40
30266 2	Ø 47	14,5	14	○	14,70
30261 7	Ø 32,5	10	4	●	4,70
30264 8	Ø 40	12	8	●	9,40
30267 9	Ø 47	14,5	14	●	14,70



**Salatschleuder „XXL“**  
**salad spinner**  
**escurreverdurás**  
**essoreuse à salade**



ideal um größere Mengen Gemüse, Früchte oder Salat nach dem Waschen zu trocknen, inkl. Ablaufschlauch

ideal for drying large amounts and fruits after washing, removable inner basket with crank handle

ideal para escurrir gran cantidad de frutas y verduras después del lavado, cesta interior desmontable

idéale pour essorer une grande quantité de salade ou légumes après leur lavage, panier intérieur

	□ cm	↑ cm	ltr.	€
88733 6	Ø 43	52	25	179,00



**Seiher  
strainer  
colador  
passoire**



mit 2 Muschelgriffen  
with 2 shell shaped grips  
con dos asas  
à 2 anses moulées

	□ cm	↑ cm	€
00780 2	Ø 36	19	9,40

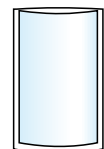

doppelwandig  
double wall



**3 Größen  
3 sizes**

**Edelstahlschale, doppelwandig  
stainless bowl, double wall  
bol inox doble pared  
bol inox double paroi**

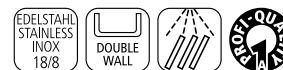

beste Isoliereigenschaften  
best insulating properties  
muy aislante  
très isolant

	□ cm	↑ cm	ltr.	€
30040 8	Ø 14	6,5	0,5	17,80
30041 5	Ø 20	9	1,5	23,00
30042 2	Ø 23	10	2,5	29,00

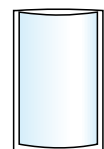

doppelwandig  
double wall



**1,8 ltr.**

**Dressingtopf, doppelwandig  
bowl, double wall  
salsera alta, doble pared  
pot à sauce, double paroi**



beste Isoliereigenschaften  
best insulating properties  
muy aislante  
très isolant

	□ cm	↑ cm	ltr.	€
30043 9	Ø 15	18	1,8	41,00



93306



93307

**Schneidebrett  
cutting board  
tabla para cortar  
planche à découper**



HDPE, mit Safrinne, mit Antirutsch-Füßchen  
HDPE, with juice groove and non-slip feet  
HDPE, con ranura para líquidos y pies antideslizantes  
HDPE, avec rigole et pieds antidérapants

	□ cm	↑ cm	●	€
93306 4	30 x 20	2	●	39,00
93307 1	50 x 30	2	●	54,00



**Backhandschuhe**  
baking mittens  
manoplas de panadero  
gants de boulanger

Leder, gefüttert, one size, mit Stulpen, extrem hitzebeständig bis 250°C  
leather, inner lining, one size, with cuffs, extremely heat resistant up to 250°C  
cuero interior forrado, talla única, resiste a temperaturas hasta 250°C  
cuir intérieur doublé, taille unique, résiste à maxi 250°C

	→ cm	€
88090 0	45	29,00



**Pizzaschaufel**  
pizza peel  
pala de pizza  
pelle à pizza



	□ cm	→ cm	€
88080 1	35 x 30,5	90	34,00
88081 8	35 x 30,5	130	41,00



**Pinsel**  
brush  
brocha  
pinceau pâtissier



weißgebleichte naphthalinfreie Borsten, temperaturbeständig von -40°C bis +95°C  
bleached bristles, heat-resistant from -40°C to +95°C  
cerdas blanqueadas, resistencia térmica -40°C hasta +95°C  
soies blanchies sans naphthaline, résistance de - 40°C à + 95°C

	□ cm	→ cm	€
77350 9	4 x 1	23,5	6,20
77351 6	5 x 1	23,5	8,20
77352 3	6 x 1	24	9,00
77353 0	7,5 x 1	24	11,80



**Gewürzkasten**  
condiment container  
especiero  
boîte à épices ou ingrédients



matt poliert, 4 herausnehmbare Einsatzschalen je 0,5 l, Scharnierdeckel aus Polycarbonat  
satin polished finish, 4 removable inserts each 0,5 l, hinged polycarbonate lid  
acabado mate, cuatro contenedores en propileno, capacidad de cada uno 0,5l, tapa policarbonato alta calidad con bisagra  
mat, 4 compartiments de 0,5 L en polypropilène, couvercle polycarbonate à charnières

	□ cm	↑ cm	ltr.	€
71700 8	31 x 15,5	9,5	4 x 0,5	23,00

**Einzelteile / spare parts / piezas sueltas / pièces détachées**

Einsatzschale / insert / contenedor 0,5 L / récipient 0,5 L

71701 5	14,2 x 7,5	7	0,5	3,70
---------	------------	---	-----	------



**NEW**



84531



84532

**Schale "MULTI"  
bowl  
cuenco  
bol**

inklusive 3 herausnehmbare Trennwände, 4 Kammern  
including 3 removable divider, 4 chambers  
con 3 divisores extraíbles, 4 compartimentos  
avec 3 parois de séparation amovibles, 4 compartiments

	cm	cm	litr.		€
84531 2	31,5 x 17,5	7	2,1	○ white	19,00
84532 9	31,5 x 17,5	7	2,1	● anthrazit	19,00

**Einzelteile / spare parts / piezas sueltas / pièces détachées**

Trenner, 6er Set / divider, 6 pcs. / divisor, 6 pz. / paroi de séparation, 6 pc.

	cm	mm		€
84533 6	16,5 x 5	3,5	○ white	6,90
84534 3	16,5 x 5	3,5	● anthrazit	6,90



**Vorratsdose mit Deckel  
canister with lid  
contenedor con tapa  
pot en verre avec couvercle**



Glaskugel mit Schraubdeckel, aromadichtem Verschluss, 1 Stck.  
glass ball, aroma-tight screw cap, 1 pc.  
bola de cristal, tapa de rosca para conservar el aroma, 1 pz.  
boule de verre, bouchon à vis de l'arôme étanche, 1 pc.

	cm	cm	litr.	€
00637 9	12,5 x 19	18	1	6,40



inkl. Löffel

**Vorratsdose  
canister with spoon  
bote con cuchara  
pot en verre avec cuillère**



Glaskugel mit Löffel, Schraubdeckel mit aromadichtem Verschluss, Edelstahl-Löffel mit magnetischem Silikongriff, 1 Stck.  
tight cover, stainless steel spoon with magnetic silicone handle, 1 pc.  
acero inoxidable, tapa de vidrio ajustable, cuchara inox con mango magnético de silicona, 1pc.  
pot en verre avec cuillère avec manche aimanté revêtu de silicone, couvercle à visser pour conserver les arômes, 1 pz.

	cm	cm	litr.	€
00636 2	Ø 20	18	3	8,40



**Küchentuchständer  
kitchen roll holder  
porta-rollo de cocina  
dérouleur papier essuie-tout**



Lieferung ohne Deko  
delivery without paper towel roll  
se entrega sin rollo  
livré sans rouleau de papier

	cm	cm	€
70303 2	Ø 18	31	13,90



**Bonspieß  
bill spike  
pinchanotas  
pique-bons**



Spieße aus flexiblen Kunststoff, mit stumpfen Enden zur Unfallverhütung  
spikes made of flexible plastic, with blunt ends to prevent accidents  
pinchos de plástico flexible  
piques en plastique flexible

	☐ cm	↑ cm		€
88855 5	9 x 5,5	10,5	1 Spieß / 1 spike 1 pincho / 1 pic	3,20
88856 2	20 x 5,5	10,5	3 Spieße / 3 spikes 3 pinchos / 3 pics	5,40

3 Längen



**Bonleiste  
bill rail  
portafichas  
barre porte-bons**



matt poliert, mit Kugel-Greifsystem, zur Wandmontage geeignet, auch mit Magneten nutzbar  
satin polished finish, small balls hold the bills, suited for wall fastening, can also be used with magnets  
acabado satinado, con sistema de bolas para colgar las notas para fijar en la pared, puede usarse con imán  
mat satiné, avec billes pour fixer sans effort tous types de fiches et papiers, peut se fixer sur plaque aimantée

	☐ cm	↑ cm		€
88900 2	40 x 8	2		16,00
88901 9	50 x 8	2		17,40
88902 6	60 x 8	2		18,90

3 Längen



**Magnet-Messerhalter  
magnetic knife rack  
barra magnética para cuchillos  
barre aimantée pour couteaux**



mit 2 Magnetschienen und Haken, aus massivem Kunststoff, zur Wandmontage geeignet, Lieferung ohne Deko  
with 2 magnet racks and hooks, strong plastic, suited for wall fastening  
con 2 rails magnéticos y ganchos, plástico macizo, fijación en pared  
avec 2 rails aimantés et crochets, plastique robuste, fixation murale

	→ cm		€
88910 1	33		7,80
88911 8	45		9,80
88912 5	60		12,00



**Schneidbrett-Ständer  
cutting board rack  
soporte para tablas  
rack pour planches à découper**



für 6 Schneidbretter bis 25 mm Stärke, Lieferung ohne Deko  
for 6 chopping boards up to 25 mm thickness  
para 6 tablas de corte de 25 mm  
pour 6 planches de 25 mm

	☐ cm	↑ cm		€
88903 3	27 x 31	28		29,00



**Sterntüllen-Satz, 10er Set**  
**set of star tubes, 10 pcs. set**  
**juego de 10 boquillas estrella**  
**jeu de 10 douilles en étoile**



aus einem Stück gezogen, 10-teilig: 4, 5, 6, 7, 8, 9, 10, 12, 13, 15 mm  
 made in one piece, 10 pcs. set: 4, 5, 6, 7, 8, 9, 10, 12, 13, 15 mm  
 fabricación de 1 sola pieza 4, 5, 6, 7, 8, 9, 10, 12, 13 y 15 mm  
 fabrication d'une seule pièce 4, 5, 6, 7, 8, 9, 10, 12, 13 et 15 mm

77331 8	€ 24,00
---------	------------



**Lochtüllen-Satz, 10er Set**  
**set of plain tubes, 10 pcs. set**  
**juego de 10 boquillas lisas redondas**  
**jeu de 10 douilles lisses rondes**



aus einem Stück gezogen, 10-teilig: 4, 5, 6, 7, 8, 9, 10, 12, 13, 15 mm  
 made in one piece, 10 pcs. set: 4, 5, 6, 7, 8, 9, 10, 12, 13, 15 mm  
 fabricación de 1 sola pieza 4, 5, 6, 7, 8, 9, 10, 12, 13 y 15 mm  
 fabrication d'une seule pièce: 4, 5, 6, 7, 8, 9, 10, 12, 13 et 15 mm

77332 5	€ 24,20
---------	------------



**Tüllenkassetten-Set, 12er Set**  
**pipng tubes set, 12 pcs. set**  
**caja de 12 boquillas**  
**boîte de 12 douilles**



Farbe: elfenbein, 12 verschiedene Tüllen: 4 Sterntüllen, 4 Lochtüllen, 4 Garniertüllen  
 ivory-coloured, 12 different tubes: 4 star tubes, 4 plain tubes, 4 decoration tubes  
 polipropileno color marfil, 12 boquillas: 4 estrellas, 4 redondas, 4 decorados surtidos  
 polypropilène couleur ivoire, 12 motifs différents: 4 en étoile, 4 ronds, 4 décors assortis

77333 2	↑ cm 6	€ 16,90
---------	-----------	------------



**Spritzbeutel**  
**pastry bag**  
**manga pastelera**  
**poche pâtissière**

Baumwollgewebe mit starker Spezialbeschichtung, mit Saum und Tüllenverstärkung, verschweißte Längsnaht, mehrmals verwendbar, undurchlässig  
 cotton fabric with strong special coating, with upper seam and reinforced tip, welded seam, useable several times, impermeable  
 tejido algodón con revestimiento especial muy resistente y refuerzo en costura y punta para uso alimenticio, costura soldada, reutilizable, impermeable  
 toile de coton avec revêtement spécial très résistant, couture soudée, base pour la douille renforcée, réutilisable, imperméable

	Größe	→ cm	€
77322 6	2	34	3,70
77323 3	3	40	4,20
77324 0	4	45	4,40
77325 7	5	50	4,70



**Dessert- und Tortenring**  
**dessert and tart ring**  
**aro de tarta**  
**cercle à gâteaux**



nahtgeschweißt  
 welded seam  
 aluminio soldado  
 aluminium, soudé

	☐ cm	↑ cm	€
77380 6	Ø 18	6	4,40
77381 3	Ø 20	6	4,80
77382 0	Ø 22	6	5,20
77383 7	Ø 24	6	5,80
77384 4	Ø 26	6	6,20
77385 1	Ø 28	6	6,60



**Tortenring**  
**cake setting ring**  
**aro de tarta**  
**cercle à gâteaux**



stufenlos verstellbar  
 adjustable  
 ajustables  
 ajustables

	☐ cm	↑ cm	€
00040 7	Ø 16,5 - 32	7	ohne Griff / without handle 7,80



**Backform**  
**cake setting ring**  
**marco pastelero**  
**forme à gateaux**



stufenlos verstellbar, aus flexiblem Edelstahl  
 adjustable  
 ajustable  
 ajustable

	☐ cm	↑ cm	€
00042 1	19 x 28 - 34 x 54	5	16,40



**Kuchen- / Quiche-Form**  
**cake / quiche mould**  
**molde tarta o quiche**  
**moule à tarte ou quiche**



Metall, Antihaft-Beschichtung, mit herausnehmbaren Bodenteil, rund gewellt  
 metal, non-sticking coating, with removable bottom, round, fluted  
 metal con revestimiento antiadhrente, fondo desmontable, borde rizado  
 métal avec revêtement antiadhérent, fond démontable, bord cannelé

	☐ cm	↑ cm	€
77302 8	Ø 24	3,5	29,90
77304 2	Ø 28	3,5	32,00
77305 9	Ø 32	3,5	36,00



**2 Seiten = 2 Teilungen**  
**12/16 - 12/18 - 14/16**

**Tortenteiler**  
**cake marker**  
**marcador de pasteles**  
**disque à marquer les parts**



elfenbein, beidseitig verwendbar, mit 2 Griffen  
 ivory-coloured, double sided, with 2 handles  
 polipropileno, color marfil, doble cara, con 2 asas  
 polypropilène, couleur ivoire, 2 faces, avec 2 poignées

	☐ cm	↑ cm		€
88060 3	Ø 26,5	2,5	12 oder 16 Segmente / 12 or 16 pcs. 12 o 16 porciones / 12 ou 16 parts	6,20
88061 0	Ø 26,5	2,5	12 oder 18 Segmente / 12 or 18 pcs. 12 o 18 porciones / 12 ou 18 parts	6,20
88062 7	Ø 26,5	2,5	14 oder 16 Segmente / 14 or 16 pcs. 14 o 16 porciones / 14 ou 16 parts	6,20



**Backblech**  
**baking sheet**  
**bandeja pastelera**  
**plaque à pâtisserie**



geloht Ø 3 mm, Materialstärke 1,5 mm, Silikon beschichtet, temperaturbeständig bis 240°C  
 perforated Ø 3 mm, coated with silicon, heat resistant up to 240°C  
 aluminio con revestimiento de silicona perforada, resistente hasta 240°  
 aluminium avec revêtement silicone, perforée, température maxi 240°

	☐ cm	GN	€
88285 0	53 x 32,5	1/1	29,80



**hitzebeständig bis 500°C**

**Ausstellblech / Thekenblech**  
**display tray**  
**bandeja pastelera**  
**plaque pâtissière**



	☐ cm	↑ cm	€
13377 8	40 x 25	2	6,90
13378 5	48 x 32	2	8,60
13379 2	60 x 40	2	10,90



**Korkuntersetzer**  
**cork mat**  
**salvamanteles**  
**dessous-de-plat liège**



ideal für Servier- und Eisenpfannen  
 ideal for iron pan  
 ideal para servir en sartenes de chapa  
 idéal pour présenter les poèles forgées sur table

	☐ cm	↑ cm	€
73750 1	Ø 24	2	11,00





**Servier- / Tortenplatte**  
**cake stand**  
**soporte para pastel**  
**présentoir à gâteaux**



hochglanzpoliert, mit hohem Fuß (fest verbunden)  
mirror polished finish, with tall foot  
acabado brillante, con pie alto  
poli brillant, pied haut

	□ cm	↑ cm	€
00466 5	Ø 34,5	13,5	49,00

**passendes Zubehör / suitable accessories**  
**accesorios a juego / accessoires assortis**



Frischhalte-Haube / cover / campana / cloche

06517 8	Ø 33	12,5	6,90
---------	------	------	------

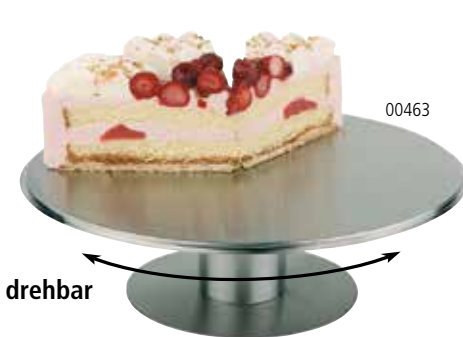

**Servierplatte / Tortenplatte „INOX“**  
**plate / cake plate**  
**porta tartas**  
**guéridon à gâteau**



matt poliert, drehbar, möbelschonende Moosgummi-Unterseite  
satin polished finish, rotating, foam rubber below to save your furniture  
acabado pulido satinado, giratorio, base revestida de goma para no rallar el mobiliario  
poli satiné, plateau tournant, revêtement mousse sous le pied pour ne pas rayer les meubles

	□ cm	↑ cm	€
00463 4	Ø 30,5	9	38,00

passende Abdeckhaube  
06510



**passendes Zubehör / suitable accessories**  
**accesorios a juego / accessoires assortis**



Frischhalte-Haube / cover / campana / cloche

06510 9	Ø 30	11,5	4,40
---------	------	------	------



**Tortenplatte**  
**cake plate**  
**porta tarta**  
**guéridon à gâteau**



Fuß hochglanzpoliert, Platte matt poliert, stabil und sehr standsicher  
foot mirror polished finish, plate satin polished finish  
pie pulido brillante, bandeja pulida mate  
pied brillant, plateau poli satin mat

	□ cm	↑ cm	€
00462 7	Ø 30	11	42,00

passende Abdeckhaube  
06510



**passendes Zubehör / suitable accessories**  
**accesorios a juego / accessoires assortis**



Frischhalte-Haube / cover / campana / cloche

06510 9	Ø 30	11,5	4,40
---------	------	------	------



**Tablett „BAKERY“  
tray  
bandeja  
plateau**



	□ cm	↑ cm		€
15130 7	Ø 18,5	1,5	○	8,40
15131 4	Ø 23,5	1,5	○	13,00
15132 1	Ø 35	1,5	○	26,00
15133 8	Ø 42,5	1,5	○	39,00



**Konditorplatte  
cake plate  
porta tartas confitería  
plateau à gâteaux avec pied**



matt poliert  
satin polished finish  
acabado efecto satinado  
poli mat effet satin

	□ cm	↑ cm		€
00046 9	Ø 31	3		12,50



**Kuchenheber  
cake lifter  
pala / bandeja para tarta  
pelle / plateau à gâteau**



spiegelblank, bessere Handhabung durch ergonomischen Griff  
shiny surface, easy handling, ergonomic handle  
superficie brillante, manejo fácil, ergonómico  
brillant, pratique, sûr et ergonomique

	□ cm		€
00045 2	Ø 30		9,90



**Tortenplatte  
cake tray  
bandeja para tarta  
plat à tarte**



Rand fixiert die Haube, mit Antirutsch-Füßchen  
carved edge fixes the cover, non-slip feet  
ranura para fijar bien la campana, pies antideslizantes  
bord rainuré pour maintenir ferme la cloche, pieds antiglisse

	□ cm	↑ cm		€
00468 9	Ø 31	4	○	15,00
00469 6	Ø 31	4	●	15,00

passende Abdeckhaube  
06510



**passendes Zubehör / suitable accessories  
accesorios a juego / accessoires assortis**



Frischhalte-Haube / cover / campana / cloche

06510 9	Ø 30	11,5		4,40
---------	------	------	--	------



83890

↑ 8 cm



83891

↑ 16 cm

**Servier- und Tortenplatte „CASUAL“**  
 cake plate  
 porta pasteles  
 présentoir à gâteaux

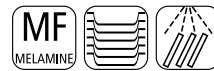

	□ cm	↑ cm	€
83890 1	∅ 31	8	24,00
83891 8	∅ 31	16	30,00



83892

↑ 8 cm



83893

↑ 16 cm

**Servier- und Tortenplatte „CASUAL“**  
 cake plate  
 porta pasteles  
 présentoir à gâteaux



	□ cm	↑ cm	€
83892 5	31 x 31	8	27,00
83893 2	31 x 31	16	32,50



83893



**Folien-Abreibvorrichtung, mit Abreibkante / Säge**  
**clingfilm tear-off-dispenser**  
**dispensador de film**  
**dérouleur de film**



**in 2 Breiten lieferbar:  
30 oder 45 cm**

mit Abreibkante / Säge-Messer, für Endlosfolie, als Tischgerät oder Wandgerät verwendbar  
 with saw, for endless rolls, can be fixed on the wall  
 con sierra para rollo de film continuo, se puede fijar en la pared  
 avec lame dentée pour rouleau de film, peut être fixé au mur

	cm	cm		€
88288 1	34 x 16	9	für Folienbreite 30 cm for film width 30 cm para film ancho 30 cm pour film largeur 30 cm	43,00
88287 4	49 x 16	9	für Folienbreite 45 cm for film width 45 cm para film ancho 45 cm pour film largeur 45 cm	48,00



**Messerabstreihbehälter**  
**knife cleaner**  
**limpiador de cuchillos**  
**dispositif pour nettoyer les lames de couteaux**



mit Aufsatz, schwere Qualität, Abstreihbacken aus Gummi in Lebensmittelqualität (verstellbar), hitzebeständig bis 80°C, Bodeneinlagen aus weichem Kunststoff zum Schonen der Messerspitzen

heavy gauge, with rubber top insert adequate for food contact and heat-resistant up to 80°C, soft plastic lower base to protect blade tips

alta calidad, limpiador de goma apto para alimentos, resistente hasta 80°C, base de plástico blando para proteger las puntas de los cuchillos

qualité professionnelle, insert supérieur nettoyeur de lames en caoutchouc alimentaire résistant maxi 80°C, base en plastique pour protéger les pointes des lames

	cm	cm	ltr.	€
88111 2	13	18	1,3	64,00



**Eiswaffel-Ständer**  
**cornet stand**  
**soporte cucuruchos**  
**support à cornets**



mit 4 Löchern, 2 x Ø 31 mm + 2 x Ø 26 mm  
 with 4 holes, 2 x Ø 31 mm + 2 x Ø 26 mm  
 con 4 agujeros, 2 x Ø 31 mm + 2 x Ø 26 mm  
 4 trous, 2 x Ø 31 mm + 2 x Ø 26 mm

	cm	cm	€
11894 2	24,5 x 9,5	9	17,60



**Eiswaffel-Ständer**  
**cornet stand**  
**soporte cucuruchos**  
**support à cornets**



matt poliert, mit 4 Löchern, 2 x Ø 31 mm + 2 x Ø 26 mm  
 satin polished finish, with 4 holes, 2 x Ø 31 mm + 2 x Ø 26 mm  
 acero inoxidable con 4 agujeros 2 x Ø 31 mm + 2 x Ø 26 mm  
 inox, 4 trous - 2 x Ø 31 mm + 2 x Ø 26 mm

	cm	cm	€
11881 2	9,5 x 27,5	9	18,50

Kellen . Rührer . Schnitzer . Wender . Zangen  
ladles . stirrer . carver . turner . tongs  
cucharones . batidores . talladores . espátulas . pinzas  
louches . fouets . bourdes . spatules . pince



**Kugelausstecher - doppelt „ORANGE“**  
**melon baller - double**  
**vaciador doble de bola**  
**moule à boule double**



zum Formen von Kugeln aus Obst, Gemüse oder Butter, Edelstahl mit geschärften Rändern  
 to form balls out of fruits, vegetables, butter, etc., stainless steel with sharpened edge  
 para hacer bolas con frutas, verduras, mantequilla, etc. acero inoxidable con borde afilado  
 pour faire des boules de fruits, légumes, beurre, etc. inox, bord affûté

	☐ cm	→ cm	€
88810 4	Ø 2,2 + 2,5	16,5	6,20
88811 1	Ø 2,2 + 3,0	17	6,30



**Kugelausstecher - oval gerippt „ORANGE“**  
**melon baller - oval fluted**  
**vaciador ovalado, acanalado**  
**moule à boule, ovale cannelée**



zum Formen von oval gerippten Kugeln aus Obst, Gemüse oder Butter, Edelstahl mit geschärften Rändern  
 to form oval fluted balls out of fruits, vegetables, butter, etc., stainless steel with sharpened edge  
 para hacer bolas con frutas, verduras, mantequilla, etc. acero inoxidable con borde afilado  
 pour faire des boules de fruits, légumes, beurre, etc. inox, bord affûté

	☐ cm	→ cm	€
88812 8	3,3 x 1,9	16	4,20



**Kugelausstecher - oval „ORANGE“**  
**melon baller - oval**  
**vaciador ovalado, liso**  
**moule à boule, ovale lisse**



zum Formen von ovalen Kugeln aus Obst, Gemüse oder Butter, Edelstahl mit geschärften Rändern  
 to form oval balls out of fruits, vegetables, butter, etc., stainless steel with sharpened edge  
 para hacer bolas con frutas, verduras, mantequilla, etc. acero inoxidable con borde afilado  
 pour faire des boules de fruits, légumes, beurre, etc. inox, bord affûté

	☐ cm	→ cm	€
88813 5	3,3 x 1,9	16	4,00



Herz-Ausstecher

**Kugelausstecher - Herzform „ORANGE“**  
**melon baller - heart-shaped**  
**vaciador - forma de corazón**  
**moule à boule en coeur**



zum Formen von Herzen aus Obst, Gemüse oder Butter, Edelstahl mit geschärften Rändern  
 to form hearts out of fruits, vegetables, butter, etc., stainless steel with sharpened edge  
 para hacer bolas con frutas, verduras, mantequilla, etc. acero inoxidable con borde afilado  
 pour faire des boules de fruits, légumes, beurre, etc. inox, bord affûté

	☐ cm	→ cm	€
88851 7	3 x 2,5	16	4,00



**Kugelausstecher „ORANGE“**  
**melon baller**  
**vaciador de melón redondo**  
**moule à boule ronde simple**



zum Formen von Kugeln aus Obst, Gemüse oder Butter, Edelstahl mit geschärften Rändern  
 to form balls out of fruits, vegetables, butter, etc., stainless steel with sharpened edge  
 para hacer bolas con frutas, verduras, mantequilla, etc. acero inoxidable con borde afilado  
 pour faire des boules de fruits, légumes, beurre, etc. inox, bord affûté

	□ cm	→ cm	€
88814 2	Ø 3	16	3,60
88815 9	Ø 2,5	16	3,50
88816 6	Ø 2,2	15,5	3,50
88817 3	Ø 1,8	15	3,50
88818 0	Ø 1,5	15	3,50
88819 7	Ø 1,0	14,5	3,50



88820



88821

**Ziseliermesser „ORANGE“**  
**lemon stripper**  
**cuchillo de decoración cincelador**  
**décore-citron ou zesteur**



zum Einritzen von Linien und Mustern in hartschaliges Obst und Gemüse, zum Schälen von Zitrusfrüchten, Edelstahl mit geschärften Rändern  
 to score lines or design in hard fruits and vegetables, to peel citrus fruits, stainless steel with sharpened edge

para esculpir líneas o hacer dibujos sobre frutas o verduras, bastante duras para pelar cítricos, acero inoxidable con borde afilado

pour découper des lignes et motifs sur fruits et légumes à peau dure ou pour peler les zestes des citrons ou oranges, inox, bord affûté

	→ cm	€
88820 3	15 für Rechtshänder / for right-handers para diestros / pour droitiers	3,00
88821 0	15 für Rechts- und Linkshänder for right- and left-handers para diestros y zurdos pour gauchers ou droitiers	3,00



**Spargelschäler „ORANGE“**  
**asparagus knife / asparagus peeler**  
**pelador de espárragos**  
**peleur à asperges**



schält Spargel sparsam und gleichmäßig, mit Stellschraube für variable Schneiddicken  
 peels asparagus curt and consistant, with adjustable screw to change the thickness of peeling  
 pela los espárragos uniformemente, tornillo para regular el grosor del pelado  
 pèle les asperges uniformément, avec vis de réglage pour l'épaisseur des pelures

	→ cm	€
88822 7	22	8,70



**Fadenschneider / Zester „ORANGE“**  
decorator / zester  
cuchillo de decoración cincelador  
couteau zesteur



zum Abziehen von feinsten Schalenstreifen, ideal zum Dekorieren von Torten und Desserts  
to peel off very fine stripes of paring, these stripes are ideal to decorate desserts, cakes, etc.  
para pelar tiras muy finas, ideal para decorar postres, tartas, etc.  
pour couper en lanières fines, idéal pour la décoration de gâteaux et desserts, etc.



	cm	→ cm	€
88823 4	Ø 0,2 + 0,5	14,5	3,50
88824 1	Ø 0,2	15	3,20



**Fadenschneider - seitlich „ORANGE“**  
decorator / zester - sideways  
cuchillo de decoración cincelador  
couteau zesteur „de côté“



zum Abziehen von feinsten Schalenstreifen, ideal zum Dekorieren von Torten und Desserts  
to peel off very fine stripes of paring, these stripes are ideal to decorate desserts, cakes, etc.  
para pelar tiras muy finas, ideal para decorar postres, tartas, etc.  
pour couper en fines lanières, idéal pour la décoration de gâteaux et desserts, etc.



	cm	→ cm	€
88825 8	Ø 0,3 + 0,4	15	3,50



**Ziseliermesser „ORANGE“**  
canele / decorating knife  
cuchillo de decoración cincelador acanalado  
couteau zesteur cannelé



zum Einritzen von Linien und Mustern in hartschaliges Obst und Gemüse, Edelstahl mit geschärften Rändern  
to score lines or design in hard fruits and vegetables, stainless steel with sharpened edge  
para dibujar líneas en frutas o verduras de piel dura, acero inoxidable con borde afilado  
pour découper des lignes et motifs sur fruits et légumes à peau dure ou pour peler les zestes des citrons ou oranges, inox, bord affûté



	→ cm	€
88826 5	15	3,50



**Sparschäler „ORANGE“**  
peeler  
pelador de espárragos  
peleur à asperges



für Links- und Rechtshänder geeignet, mit zwei starren Klingen aus extra geschärftem + gehärtetem Edelstahl  
useable left- and right handed, with 2 inflexible blades made out off sharpened, extra hardened stainless steel  
para diestros y zurdos, con 2 cuchillas rígidas inox afiladas y muy resistentes  
pour gauchers ou droitiers, 2 lames rigides affûtés en inox extra-résistant



	→ cm	€
88827 2	17	2,30





**Orangenschäler „ORANGE“**  
**orange peeler**  
**pelador de naranjas**  
**peleur à oranges**



zum Einritzen von Linien in hartschaligen Zitrusfrüchten, zum Schälen von Zitrusfrüchten, ohne das Fruchtfleisch zu verletzen, Edelstahl mit Ziselierhaken

to score lines and design hard fruits and vegetables, to peel fruits without bashing the pulp, stainless steel with hook

para dibujar líneas en frutas y verduras de piel dura para pelar cítricos sin dañar la pulpa, acero inoxidable con gancho

pour découper des lignes et motifs sur fruits et légumes à peau dure ou pour peler les citrons ou oranges sans endommager la pulpe, inox, bord affûté



	→ cm	€
88828 9	17,5	3,10



**Pizzateigschneider „ORANGE“**  
**pizza cutter**  
**cortador de pizza**  
**roulette à pizza**



zum einfachen Zerteilen von Pizza

to cut pizza easily

para cortar pizza fácilmente

pour une coupe facile de la pizza



	cm	→ cm	€
88829 6	∅ 6	18,5	4,30



**Teigrad - gewellt „ORANGE“**  
**pastry cutter - fluted wheel**  
**cortador de pastelería- rueda dentada**  
**roulette à pâte, cannelée**



ideal zur Pasta-Herstellung, zum leichten Trennen von Teig

ideal for making pasta, to cut dough easily

ideal para la pasta

idéal pour les pâtes maison



	cm	→ cm	€
88830 2	∅ 6	18,5	4,30



**Butterroller „ORANGE“**  
**butter curler**  
**rizador de mantequilla**  
**coquilleur à beurre**



zum Formen von dekorativen Butterflocken

to form decorative curls out of butter

para formar rizos decorativos con mantequilla

pour faire des rubans et coquilles de beurre



	→ cm	€
88831 9	19	3,60



**Dekoriermesser „ORANGE“**  
**fruit decorating knife**  
**cuchillo para decorar fruta**  
**denteleur**



zur attraktiven Dekorierung von Früchten und Gemüse, Edelstahl mit geschärften Rändern  
 to decorate fruits and vegetables attractive, stainless steel with sharpened edge  
 para decorados atractivos de frutas y verduras, acero inoxidable con borde afilado  
 pour une découpe attractive et originale des kiwis, tomates, melons et autres fruits ou légumes

	→ cm	€
88832 6	16	3,50



**Pellkartoffelgabel „ORANGE“**  
**potato holder**  
**tenedor aguanta patatas**  
**pic à pommes de terre**



zum Aufnehmen und Halten von heißen Kartoffeln, mit drei Drahtzinken  
 to pick up and hold hot potatoes with three prongs  
 para sujetar patatas calientes con 3 pinchos  
 pour tenir les pommes de terre et ainsi les peler sans se brûler, trident

	→ cm	€
88833 3	16	3,20



**Pendelschäler „ORANGE“**  
**swivel peeler**  
**pelador lama pivotante**  
**peleur lame pivotante**



zum schnellen und sparsamen Schälen von Obst und Gemüse, mit beweglicher Klinge  
 to peel fruits and vegetables with flexible blade  
 para pelar frutas y verduras con hoja flexible  
 pour couper des fruits et légumes avec lame flexible

	→ cm	€
88834 0	17	4,30



**Entstieler / Entkerner „ORANGE“**  
**tomato corer**  
**quita-rabillo de tomate**  
**équeuteur à tomates**



zum einfachen Entfernen des Tomatenstiels, aus Edelstahl mit gezackter Krone  
 to remove the peduncles from tomatoes in one movement, can be used to remove the pulp of the tomato

ideal para cortar el rabo de los tomates de 1 gesto, o para hacer bolas de pulpa de tomate, inox, dentado

pour ôter la queue de la tomate en 1 seul geste ou pour former des boules avec la pulpe, inox, dentelé

	□ cm	→ cm	€
88835 7	2 x 2	15	3,70



**Apfelentkerner „ORANGE“**  
**apple corer**  
**descorazonador de manzana**  
**vide-pomme**



durch leichtes Drehen kann das Kerngehäuse von Äpfeln, Birnen und anderen Früchten sorgsam herausgeholt werden, Edelstahl mit geschärften Rändern

with a light turn cores of apples, pears and other fruits can be cut off easily, stainless steel with sharpened edge

para descorazonar muy fácilmente manzanas, peras y otras frutas

pour évider facilement les pommes, poires ou autres fruits



	□ cm	→ cm	€
88836 4	Ø 2,2	21	2,70
88837 1	Ø 1,6	18,5	2,60



**Dreieck-Garnierschneider „ORANGE“**  
**decorator / radish decorator**  
**cincelador triangular**  
**couteau ciseleur triangle**



zur Herstellung von Radieschenkronen, zur Verzierung von Gemüse und Obst, Edelstahl mit geschärften Rändern

to cut lines and design in fruits and vegetables, stainless steel with sharpened edge

para cortar líneas y hacer dibujos en frutas y verduras, acero inoxidable con borde afilado

pour dessiner ligne et motifs sur les fruits et légumes à peau dure, lame affûtée, inox



	→ cm	€
88838 8	14	3,20



**Austernöffner „ORANGE“**  
**oyster knife**  
**abre ostras**  
**couteau à huîtres**



zum einfachen Aufbrechen von Austern, mit Fingerschutz, Edelstahl mit geschärften Rändern

to open oysters easily, with guard, stainless steel with sharpened edge

para abrir ostras fácilmente con protección para los dedos, acero inoxidable con punta afilada

pour ouvrir facilement les huîtres avec protection pour les doigts, inox, pointe affûtée



	→ cm	€
88839 5	14,5	6,00



**Austernmesser „ORANGE“**  
**oyster knife**  
**abre ostras**  
**couteau à huîtres**



Edelstahl-Klinge zum Einstechen in die Schale, mit Fingerschutz

to open oysters easily, with guard

para abrir ostras fácilmente con protección para los dedos

pour ouvrir facilement les huîtres avec protection pour les doigts



	→ cm	€
88840 1	15	3,40



**Grapefruitmesser „ORANGE“**  
**grapefruit knife**  
**cuchillo para pomelo**  
**couteau à pamplemousse**



zum Filetieren von Zitrusfrüchten, inkl. Ziselierhaken zum Einritzen der Schale, Edelstahl mit beidseitigem Sägeschliff

to fillet citrus fruits incl. sharpened hook, to open the paring, stainless steel serrated on both sides

para cortar la pulpa del pomelo, hoja curvada dentada por ambos lados para zurdos y diestros, final en punta para pinchar, inox

lame fine recourbée microdentée des 2 côtés pour droitiers/gauchers, coupe aisément la chair du fruit et la lame en pointe permet de la piquer, inox

	→ cm	€
88841 8	21	4,40



**Zucchinienkerner „ORANGE“**  
**courgette / zucchini cutter**  
**vaciador para calabacín**  
**évideur à courgette**



zum Entkernen von Zucchini oder ähnlichem Obst und Gemüse, Edelstahl mit geschärfter Spitze und gezackter Klinge

to remove cores out of zucchini and alike fruits and vegetables, stainless steel with sharpened top and serrated blade

para vaciar el corazón del calabacín o de cualquier otra fruta o verdura, acero inoxidable con hoja de sierra afilada

pour évider courgettes, aubergines, concombres ou autres fruits et légumes allongés, lame inox dentée et pointe affûtée

	→ cm	€
88842 5	23	3,00



**Dekoriermesser „ORANGE“**  
**decorating knife „cannelé“**  
**cuchillo acanalador**  
**couteau cannelé**



gezahnte Klinge aus geschärftem Edelstahl

serrated sharpened blade, stainless steel

hoja de sierra afilada, acero inoxidable

lame inox microdentée

	→ cm	€
88843 2	19	4,90



**Tourniermesser „ORANGE“**  
**paring knife**  
**cuchillo curvado**  
**couteau d'office bec d'oiseau**



Klinge in Schnabelform, Klinge passt sich Rundungen perfekt an

with curved blade, blade adaptes perfect to curves

con hoja curva, acero inoxidable, hoja perfecta para productos redondos

lame inox, idéale pour produits ronds

	→ cm	€
88844 9	17,5	3,80



**Gemüsemesser „ORANGE“**  
paring knife  
cuchillo mondador  
couteau d'office



zum schnellen Schälen von Gemüse  
to cut vegetables and fruits quickly  
para cortar frutas y verduras con rapidez, acero inoxidable  
lame inox, idéale pour la coupe rapide de fruits et légumes



	→ cm	€
88845 6	21	3,80



**Cocktailmesser**  
bar knife  
cuchillo para cóctel  
couteau cocktail



mit 2 Zinken zum Aufspießen von Zitruscheiben  
with 2 prongs to pick up slices of lemon  
con 2 dientes para pinchar las rodajas de limón, etc.  
avec 2 dents pour les rondelles de citron et autres décorations



	→ cm	€
88846 3	21	3,80



**Käsemesser „ORANGE“**  
cheese knife  
cuchillo de queso  
couteau à fromage



	→ cm	€
88847 0	21	3,80



**Julienneschneider „ORANGE“**  
julienne cutting knife  
cuchillo para cortar juliana  
couteau à julienne



zum Schneiden feiner Streifen aus Gemüse oder Obst  
to cut fine stripes out off fruits and vegetables  
para cortar a tiras finas las frutas y verduras, inox, hoja afilada  
pour couper en fines lanières les fruits et légumes



	→ cm	€
88848 7	18,5	15,00



**Pendelschäler „ORANGE“**  
**swivel peeler**  
**pelador reversible**  
**éplucheur droitier/gaucher**



für Links- und Rechtshänder geeignet, mit 2 beweglichen Klingen  
 suitable for right and left handed, with 2 flexibles blades  
 apto para zurdos como para diestros, con 2 hojas flexibles acero inoxidable  
 adapté pour droitiers ou gauchers, lame inox flexible

	→ cm	€
88849 4	19	3,80



**Pendelschäler „ORANGE“**  
**swivel peeler**  
**pelador de tomate**  
**éplucheur à tomates**



für Links- und Rechtshänder geeignet, ideal für das Schälen von Tomaten, mit 2 beweglichen Klingen

suitable for right and left handed, ideal to peel tomatoes, with 2 flexibles blades  
 apto para diestros y zurdos, ideal para pelar tomates, con 2 hojas flexibles  
 pour gauchers ou droitiers, idéal pour peler les tomates, 2 lames flexibles

	→ cm	€
88850 0	16,5	3,70



**Fischentschupper / Fischschaber „ORANGE“**  
**fish scaler**  
**escamador**  
**écailleur à poisson**



zum einfachen Entfernen von Schuppen, ohne die Fischhaut einzureißen

to scale fish easily  
 para quitar las escamas con facilidad  
 pour ôter facilement les écailles

	→ cm	€
88852 4	20	6,30



**Käsehobel „ORANGE“**  
**cheese slicer**  
**rebanador de queso**  
**couteau tranche-fromage**



zum Schneiden von dünnen Käsescheiben

to cut thin slices of cheese  
 para cortar lonchas finas de queso  
 pour couper de fines tranches de fromage

	→ cm	€
88853 1	21,5	4,90



**Apfel- / Zwiebelteiler**  
**apple / onion divider**  
**porcionador de manzana / -cebolla**  
**coupe-pomme ou oignon en quartiers**



stabile Profiausführung, Klingen aus gehärtetem, geschärften Klingenstahl, geeignet für Früchte max. Ø 10 cm

heavy gauge, extra sharpened steel blades, max. Ø 10 cm

aluminio fundido de alta calidad, cuchillas de acero afilado extra max. Ø 10 cm

fonte d'aluminium, qualité extra, lames inox affûtées, Ø 10 cm

	□ cm	↑ cm	€
88854 8	11 x 17	4,5	7,60



**Streichpalette „BLUE“**  
**spatula**  
**espátula**  
**spatule**



flexible Edelstahl-Klinge, rutschfester Griff, hitzebeständig

flexible blade stainless steel, non-slip handle, heat-resistant

hoja flexible acero inoxidable mango polipropileno termoresistente anti-deslizante

lame inox flexible, manche antiglisse en polypropilène thermorésistant



	□ cm	→ cm	€
88920 0	35 x 5	48,5	8,20
88921 7	30,5 x 4,5	43,5	7,20
88922 4	25 x 4	38	6,60
88923 1	20 x 3	33,5	5,60
88924 8	15 x 4	28	5,20
88925 5	15 x 3	28	5,00



**Palette „BLUE“**  
**spatula**  
**espátula**  
**spatule**



flexible Edelstahl-Klinge, rutschfester Griff, hitzebeständig

flexible blade stainless steel, non-slip handle, heat-resistant

hoja flexible acero inoxidable mango polipropileno termoresistente anti-deslizante

lame inox flexible, manche antiglisse en polypropilène thermorésistant



	□ cm	→ cm	€
88926 2	15 x 5,5	27	5,90
88927 9	17 x 5	30,5	6,00



**Winkelpalette „BLUE“**  
**spatula**  
**espátula**  
**spatule**

flexible Edelstahl-Klinge  
 flexible blade stainless steel  
 hoja flexible acero inoxidable  
 lame inox flexible



	cm	→ cm	€
88928 6	17 x 5	30	6,10



**Spachtel / Schaber „BLUE“**  
**spatula**  
**paleta triangular**  
**spatule triangulaire**

starre Edelstahl-Klinge  
 rigid blade stainless steel  
 hoja rígida acero inoxidable  
 lame inox rigide



	cm	→ cm	€
88929 3	12 x 10	25	6,80



**Gebäckpalette „BLUE“**  
**pastry spatula**  
**paleta pastelera**  
**spatule pâtissière**

flexible Edelstahl-Klinge  
 flexible blade stainless steel  
 hoja rígida acero inoxidable  
 lame inox rigide



	cm	→ cm	€
88931 6	15,5 x 5,5	28	5,50
88932 3	17 x 7,5	29,5	6,40



**Wender „BLUE“**  
**turner**  
**espátula**  
**spatula**

flexible Edelstahl-Klinge  
 flexible blade stainless steel  
 hoja flexible acero inoxidable  
 lame inox flexible



	cm	→ cm	€
88933 0	15 x 6	27,5	5,40
88934 7	9 x 6	19	3,60





**Winkelpalette „BLUE“**  
**spatula**  
**espátula**  
**spatule**



flexible Edelstahl-Klinge  
 flexible blade stainless steel  
 hoja flexible acero inoxidable  
 lame inox flexible



	cm	→ cm	€
88935 4	34 x 5	47,5	8,40
88936 1	29 x 4,5	42,5	7,20
88937 8	24 x 4	36	6,40
88938 5	18,5 x 3	32	5,70



**Wender „BLUE“**  
**turner**  
**espátula**  
**spatule large coudée XL**



flexible Edelstahl-Klinge  
 flexible blade stainless steel  
 hoja flexible de acero inoxidable  
 lame flexible inox



	cm	→ cm	€
88939 2	24 x 7,5	37,5	8,20



**Wender „BLUE“**  
**turner**  
**espátula**  
**spatule**



perforiert, flexible Edelstahl-Klinge  
 perforated, flexible blade stainless steel  
 hoja flexible inox agujereada  
 lame ajourée inox flexible



	cm	→ cm	€
88940 8	24,5 x 7,5	37,5	8,50



**Wender „BLUE“**  
**turner**  
**espátula para plancha**  
**spatule large coudée**



flexible Edelstahl-Klinge  
 flexible blade stainless steel  
 hoja flexible de acero inoxidable  
 lame flexible inox



	cm	→ cm	€
88941 5	20 x 7,5	33	7,20
88942 2	15 x 9	28	7,20
88943 9	14,5 x 5,5	27	6,00



**Wender „BLUE“  
turner  
espátula  
spatule**



geschlitzt, flexible Edelstahl-Klinge  
slotted, flexible blade stainless steel  
hoja flexible inox agujereada  
lame ajourée inox flexible



	cm	→ cm	€
88944 6	17 x 8,5	30	5,40



**Spachtel / Fettabstecher „BLUE“  
scraper  
espátula plancha  
spatule coudée spéciale grill**



starre Edelstahl-Klinge  
rigid blade stainless steel  
hoja rígida de acero inoxidable  
lame rigide inox



	cm	→ cm	€
88945 3	17,5 x 8	30	7,40
88946 0	17 x 10	30	8,20
88947 7	15 x 7,5	28	6,80



**Aufstrichmesser „BLUE“  
sandwich knife  
cuchillo para untar  
couteau à tartiner**



flexible Edelstahl-Klinge  
flexible blade stainless steel  
hoja flexible de acero inoxidable  
lame flexible inox



	cm	→ cm	€
88948 4	8,5 x 3	18,5	2,40



**Pizzaschneider „BLUE“  
pizza cutter  
cortador de pizza  
coupe-pizza**



ergonomischer Griff  
ergonomic handle  
mango ergonómico  
manche ergonomique



	cm	→ cm	€
88949 1	Ø 10	20	6,00



**Teigschaber / Abstecher „BLUE“**  
**dough scraper**  
**corta pasta**  
**coupe-pâte**



starre Edelstahl-Klinge  
 rigid blade stainless steel  
 hoja rígida de acero inoxidable  
 lame rigide inox

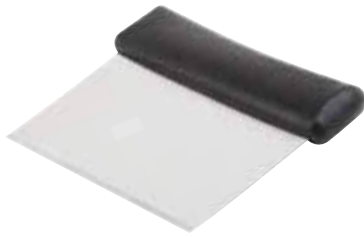

	cm		€
88930 9	15,5 x 8		4,60



**Wender „PRO“**  
**turner**  
**espátula**  
**spatule coudée**



flexible Edelstahl-Klinge  
 flexible blade stainless steel  
 hoja inox flexible  
 lame inox flexible

	cm	→ cm	€
88701 5	12 x 8,7	29	12,00



**Pizzaschneider „PRO“**  
**pizza cutter**  
**cortador de pizza**  
**coupe-pizza**



ergonomischer Griff  
 ergonomic handle  
 mango ergonómico  
 manche ergonomique

	cm	→ cm	€
88727 5	Ø 10	25	9,60

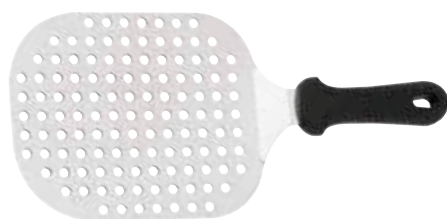

**Pizzaheber „PRO“**  
**pizza server**  
**pala pizza**  
**pelle à pizza**



geloht, ergonomischer Griff  
 perforated, ergonomic handle  
 perforada, mango ergonómica  
 perforée, manche ergonomique

	cm	→ cm	€
88631 5	22 x 18	38	23,00

# STOP-TOOLS designed by formel<sup>23</sup> PRODUKTDESIGN

Die **STOP**-Funktion verhindert, dass Gabel oder Löffel in das Gefäß rutschen.

The smart **STOP**-function prevent forks and spoon not to slip into the vessel.

La función **STOP** evita que los cubiertos se caigan dentro del recipiente. Antideslizante.

La fonction **STOP** empêche les couverts de glisser dans le récipient.



**Fleischgabel**  
meat fork  
tenedor de carne  
fourchette à viande



Materialdicke 2,5 mm, ergonomischer rutschfester Griff  
ergonomic antislip handle  
mango ergonómico antideslizante  
manche ergonomique antidérapante

	cm	→ cm	€
00831 1	10,5	38,5	9,40



**Schöpflöffel**  
ladle  
cucharón  
louche



Materialdicke 2,5 mm, ergonomischer rutschfester Griff  
ergonomic antislip handle  
mango ergonómico antideslizante  
manche ergonomique antidérapante

	cm	→ cm	€
00832 8	Ø 9	35	9,90



**Servierlöffel geschlitzt**  
slotted spoon  
cuchara de servicio  
cuillère de service



Materialdicke 2,5 mm, ergonomischer rutschfester Griff  
ergonomic antislip handle  
mango ergonómico antideslizante  
manche ergonomique antidérapante

	cm	→ cm	€
00833 5	10 x 7,5	37,5	9,60



**Servierlöffel**  
spoon  
cuchara de servicio  
cuillère de service



Materialdicke 2,5 mm, ergonomischer rutschfester Griff  
ergonomic antislip handle  
mango ergonómico antideslizante  
manche ergonomique antidérapante

	cm	→ cm	€
00834 2	10 x 7,5	37,5	9,60



Das Profimaterial Polyamid besteht aus Nylon und Fiberglas. Hitzebeständig bis 220°C, extra hochwertige Profi-Qualität, gut geeignet für antihafbeschichtete Pfannen, ergonomischer Griff.

Polyamide is made of nylon and fiberglass. Heat-resistant up to 220°C, extra high quality, perfect for non-stick-coated pots and pans, ergonomic handle.

Poliamide de nylon y fibra de vidrio. Brevemente al calor hasta 220°, calta calidad profesional, ideal para sartenes antiadherentes, mango ergonómico.

Polyamide de nylon et fibre de verre, haute résistance brièvement à la chaleur jusque 220°C, qualité professionnelle, idéal pour les poêles antiadhérentes, manche ergonomique.

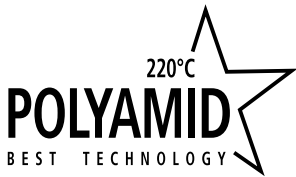

**Pfannenwender**  
turner  
espátula  
spatule



	cm	→ cm	€
00600 3	11,5 x 9,5	35	5,20



**Pfannenwender**  
turner  
espátula  
spatule



	cm	→ cm	€
00604 1	15 x 7,5	30	3,70



**Bratenwender**  
turner  
espátula  
spatule



	cm	→ cm	€
00603 4	11 x 9,5	35	5,30



**Pfannenwender**  
turner  
espátula  
spatule



	cm	→ cm	€
88640 7	13 x 6,5	29	3,70



**Pfannenwender**  
turner  
espátula  
spatule



	cm	→ cm	€
88642 1	14 x 7	29	3,80



**Schaumlöffel**  
skimmer  
espumadera  
écumoire



	cm	→ cm	€
00602 7	Ø 11,5	36,5	5,30



**Schöpflöffel**  
ladle  
cucharón  
louche



	cm	→ cm	€
00606 5	Ø 9	32	5,50



**Servierlöffel**  
spoon  
cuchara  
cuillère



	cm	→ cm	€
88608 7	12 x 7	35	5,20
00607 2	12 x 7	35	perforiert 5,00



**Spaghettizange**  
spoon  
pinza espaguetis  
pince universelle ou à spaghettis



	cm	→ cm	€
88637 7	9	24	5,30



**Salat-Zange**  
salad tong  
pinza ensalada  
pince à salade



	cm	→ cm	€
00605 8	10 x 6	33	5,50



**Toast-Zange**  
sandwich tong  
pinza para sandwich  
pince à toasts



	cm	→ cm	€
00601 0	10 x 8	28	6,80

NEW



Pfannenwender  
turner  
espátula  
spatule



	cm	→ cm	€
00645 4	9,0 x 8,5	21	3,90

NEW



Schaumlöffel  
skimmer  
espumadera  
écumoire



	cm	→ cm	€
00646 1	Ø 10,5	23	3,90

NEW



Servierlöffel  
spoon  
cuchara  
cuillère



	cm	→ cm	€
00647 8	10 x 6	21	3,90

NEW



Schöpflöffel  
ladle  
cucharón  
louche



	cm	→ cm	€
00648 5	9 x 8	23	3,90

NEW



Spaghettilöffel  
spaghetti spoon  
cuchara para espaguetis  
cuillère à spaghettis



	cm	→ cm	€
00649 2	9 x 7	23	3,90

Portionierhilfe = 1 Portion



**Fleischgabel**  
**meat fork**  
**tenedor de carne**  
**fourchette à viande**



	cm	→ cm	€
00666 9	7 / 10	34	6,40

**rutschsichere Griffe, schwarzer Griff, hitzebeständig bis 120°C**  
**antislip, black handle, heat-resistant up to 120°C**  
**antideslizante, mango negro, resiste hasta + 120°C**  
**antiglisse, manche noir, résistant à +120°C**



**Schöpflöffel**  
**ladle**  
**cucharón**  
**louche**



	cm	→ cm	ltr.	€
00670 6	9 x 9	34	0,15	7,00



**Servierlöffel**  
**spoon**  
**cuchara**  
**cuillère**



	cm	→ cm	€
00662 1	10,5 x 7	34	6,40



**Servierlöffel gelocht**  
**slotted spoon**  
**cuchara de servicio**  
**cuillère de service**



	cm	→ cm	€
00664 5	10,5 x 7	34	6,40



**Bratenwender**  
**slotted turner**  
**espátula para plancha**  
**spatule pour le grill**



	cm	→ cm	€
00668 3	10 x 8	36	7,00





**Schöpflöffel „PROFI“**  
ladle  
cacillo  
louche



	cm	→ cm	ltr.	€
00710 9	Ø 5	32,0	0,030	11,40
00711 6	Ø 6	34,0	0,050	12,00
00712 3	Ø 7	35,5	0,080	12,40
00713 0	Ø 8	38,0	0,125	13,50
00714 7	Ø 9	42,0	0,150	15,40
00715 4	Ø 10	43,5	0,250	16,20
00716 1	Ø 11	45,0	0,300	16,80
00717 8	Ø 14,5	48,0	0,550	17,80



**Schaumlöffel „PROFI“**  
skimmer  
espumadera  
écumoire



	cm	→ cm	€
00720 8	Ø 8	37,0	11,80
00721 5	Ø 10	40,5	13,00
00722 2	Ø 12	46,0	14,00
00723 9	Ø 14	50,5	15,20



**Wender „PROFI“**  
turner  
espátula  
spatule



	cm	→ cm	€
00730 7	10 x 11,5	52	15,20



**Servierlöffel „PROFI“**  
spoon  
cuchara de servicio  
cuillère de service



	cm	→ cm	€
00672 0	10,5 x 7	41	9,00



**Servierlöffel geschlitzt „PROFI“**  
slotted spoon  
cuchara de servicio agujereada  
cuillère de service ajourée



	cm	→ cm	€
00671 3	10,5 x 7	41	9,00



**Spaghettilöffel „PROFI“**  
spaghetti spoon  
cuchara de espaguetis  
cuillère à spaghettis



	cm	→ cm	€
00673 7	11 x 6,5	39	9,80

**Schneebeesen  
whisk  
batidor  
fouet professionnel**



**8 Drähte**

88708 - 88710



**11 Drähte**

88712 - 88714

	→ cm		€
88708 4	35	8 Drähte Ø 2,3 mm / 8 wires Ø 2,3 mm batidor 8 hilos Ø 2,3 mm / fouet 8 fils Ø 2,3 mm	16,80
88709 1	45	8 Drähte Ø 2,3 mm / 8 wires Ø 2,3 mm batidor 8 hilos Ø 2,3 mm / fouet 8 fils Ø 2,3 mm	17,90
88710 7	55	8 Drähte Ø 2,3 mm / 8 wires Ø 2,3 mm batidor 8 hilos Ø 2 mm / fouet 8 fils Ø 2 mm	22,00
88712 1	25	11 Drähte Ø 1,5 mm / 11 wires Ø 1,5 mm batidor 11 hilos Ø 1,5 mm / fouet 11 fils Ø 1,5 mm	11,80
88713 8	35	11 Drähte Ø 1,5 mm / 11 wires Ø 1,5 mm batidor 11 hilos Ø 1,5 mm / fouet 11 fils Ø 1,5 mm	14,50
88714 5	45	11 Drähte Ø 2,5 mm / 11 wires Ø 2,5 mm batidor 11 hilos Ø 2,5 mm / fouet 11 fils Ø 2,5 mm	17,90

**Schneebeesen  
whisk  
batidor  
fouet**



matt poliert, mit Hohlgriff, 8 Drähte  
satin polished finish, with hollow handle, 8 wires  
inox con mango hueco, 8 hilos  
inox, manche creux, 8 fils

	→ cm		€
00744 4	28	8 Drähte Ø 1,5 mm / 8 wires Ø 1,5 mm 8 hilos Ø 1,5 mm / fouet 8 fils Ø 1,5 mm	6,90
00745 1	33	8 Drähte Ø 1,5 mm / 8 wires Ø 1,5 mm 8 hilos Ø 1,5 mm / fouet 8 fils Ø 1,5 mm	6,90
00746 8	38	8 Drähte Ø 1,5 mm / 8 wires Ø 1,5 mm 8 hilos Ø 1,5 mm / fouet 8 fils Ø 1,5 mm	8,90
00747 5	43	8 Drähte Ø 1,5 mm / 8 wires Ø 1,5 mm 8 hilos Ø 1,5 mm / fouet 8 fils Ø 1,5 mm	10,20
00740 6	48	8 Drähte Ø 2,3 mm / 8 wires Ø 2,3 mm 8 hilos Ø 2,3 mm / fouet 8 fils Ø 2,3 mm	10,60

**Kesselbesen XXL  
large whisk  
batidor gigante  
fouet géant**



matt poliert / satin polished finish / inox / inox, mat

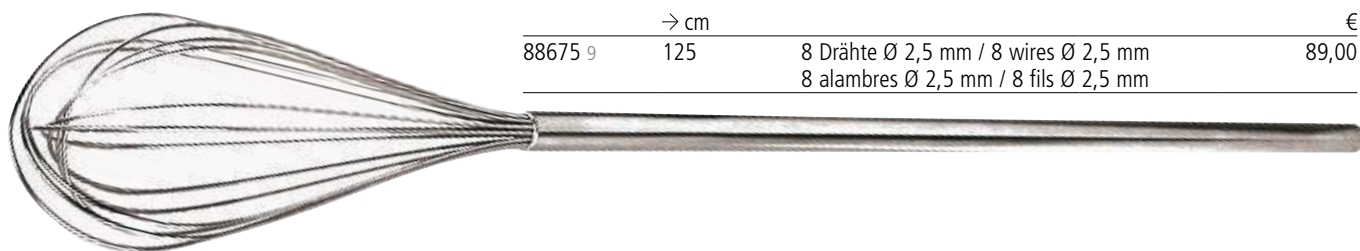

	→ cm		€
88675 9	125	8 Drähte Ø 2,5 mm / 8 wires Ø 2,5 mm 8 alambres Ø 2,5 mm / 8 fils Ø 2,5 mm	89,00

125 cm

**Kartoffelstampfer XXL**  
**masher**  
**machacador**  
**pilon**

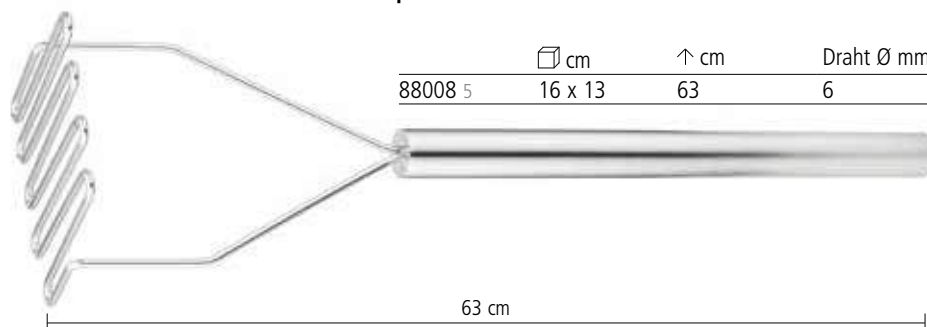

	□ cm	↑ cm	Draht Ø mm	€
88008 5	16 x 13	63	6	30,00

**Back- / Pommies-Frites Schaufel**  
**chip shovel**  
**pala para patatas fritas**  
**pelle à frites**



mit geschlossenem Hohlgriff, schwere Qualität  
 closed hollow handle, heavy gauge  
 mango hueco cerrado alta calidad  
 manche creux fermé, qualité extra

	→ cm	€
88601 8	33	36,00

**Pommies-Frites Abfüll-Schaufel**  
**chip bagger**  
**recogedor para patatas fritas**  
**pelle à frites**



matt poliert, Schaufel 23 x 21 cm, Stiel 14 cm  
 satin polished finish, shovel 23 x 21 cm, handle 14 cm  
 pulido satinado con asa, 23 x 21 cm, mango de 14 cm  
 mat, avec anse, 23 x 21 cm, manche 14 cm

		€
88019 1	für Rechtshänder / for right hander para diestros / pour droitiers	12,80

**Gemüsehobel, Mandoline**  
**mandolin**  
**mandolina**  
**mandoline**



mit 7 verschiedenen Klingen, Anti-Rutsch-Gestell, Schutzabdeckung, Klingenbreite 10 cm  
 with 7 interchangeable blades, non-slip folding stand, safety guard, blade width 10 cm  
 con 7 cuchillas intercambiables, pie plegable anti-deslizante, carro de seguridad, anchura de corte 10 cm

7 peignes interchangeables, pied repliable anti-glisse, chariot, largeur de coupe 10 cm

	□ cm	↑ cm	€
88688 9	40,5 x 12	5 / 25	72,00



mit 7 verschiedenen Klingen



rund

**Eisportionierer**  
**portioner / ice cream scoop**  
**racionador / cuchara para helado**  
**portionneur à glace**



hochglanzpoliert, mit Edelstahlfeder, Feder ist physikalisch bedingt nicht korrosionsbeständig  
 mirror polished finish, spring steel, spring is not stainless  
 pulido brillante, muelle de acero especial, no resistente al óxido  
 poli brillant, ressort acier spécial, non résistant à l'oxydation

	☐ cm	→ cm	ltr.	€
71001 6	Ø 4,5	21	1/36	10,50
71002 3	Ø 4,7	21,5	1/30	10,50
71003 0	Ø 5,0	21,5	1/24	10,50
71004 7	Ø 5,3	22	1/20	10,50
71005 4	Ø 5,5	22	1/16	10,50
71006 1	Ø 6,5	23	1/12	10,50



oval

**Eisportionierer**  
**ice cream scoop**  
**cuchara para helado, ovalada**  
**cuillère à glace ovale**



hochglanzpoliert, mit Edelstahlfeder, Feder ist physikalisch bedingt nicht korrosionsbeständig, Kugel-Größe 5,8 x 4,6 cm  
 mirror polished finish, spring steel, spring is not stainless, scoop size 5,8 x 4,6 cm  
 acabado brillante, muelle de acero especial no resistente al óxido, tamaño de la bola 5,8 x 4,6 cm  
 brillant, ressort acier spécial, non résistant à l'oxydation, boule 5,8 x 4,6 cm

	☐ cm	→ cm	ltr.	€
71008 5	22,5 x 6	22,5	1/30	12,00



**Spieße / Spießaufhänger**  
**skewer / espetada and kebab skewer rack**  
**soporte para brochetas**  
**support pour brochettes**



zum Servieren von Fleischspießen bis 40 cm, Gestell aus 8 mm Edelstahl  
 to serve skewers up to 40 cm, wire stainless steel 8 mm  
 para servir brochetas de carne hasta 40 cm, grosor del alambre 8 mm, inox  
 pour présenter les brochettes long. maxi 40 cm, fil 8 mm, inox

	☐ cm	↑ cm	€
75001 2	Ø 22	46	33,00
75002 9	Ø 0,3	40	8,00



**Messlöffelsatz**  
**set measuring spoon**  
**juego de cucharas medidoras**  
**jeu de cuillère à mesure**



Löffel hochglanzpoliert, Stiele matt poliert, Skalierung: 1 Essl., 1 Teel., 1/2 Teel., 1/4 Teel.  
 bowl mirror polished finish, handles satin polished finish, measures: table spoon, tea spoon, 1/2 tea spoon, 1/4 tea spoon  
 bol medidor brillante, mango mate medidas: 1 cuchara de sopa, 1 cuchara de té, 1/2 cuchara de té, 1/4 cuchara de té  
 corps brillant, manche mat, mesures: 1 cuillerée à soupe, 1 cuillerée à thé, 1/2 cuillère à thé, 1/4 de cuillère à thé

	cm		€
75600 7	14 x 4,5		5,80



**Teebrühsieb**  
**snap mesh tea ball**  
**infusor de té, pinza con malla**  
**boule à thé avec pince**



matt poliert, mit feinem Sieb, aufklappbar  
 satin polished finish, with fine mesh, hinged  
 acabado pulido efecto satinado, con malla fina, con bisagra  
 inox mat, maille fine, avec charnière

	cm	→ cm	€
74750 0	Ø 4,5	15,5	2,10



**Hummerbrecher**  
**lobster cracker**  
**pinza bogavante**  
**pince à homard**



	cm		€
74201 7	14 x 5,5		5,00



**Eierschneider**  
**egg cutter**  
**cortahuevos**  
**coupe-oeufs**



zum Längs- und Querteilen von hart gekochten Eiern  
 to cut hard-boiled eggs  
 corta a rodajas un huevo duro  
 en rondelles

	cm	↑ cm	€
88099 3	14,5 x 8	2,5	2,10



**Salatzange**  
**salad serving tong**  
**pinza de ensalada**  
**pince à servir la salade**



hochglanzpoliert, einfache Handhabung  
 mirror polished finish, convenient handling  
 pulido brillante, manejo cómodo  
 brillant, manipulation aisée



	cm	€
00685 0	25 x 6,5	15,00



**Universalzange**  
**multipurpose tong**  
**pinzas multiusos**  
**pince multi-usages**



hochglanzpoliert, einfache Handhabung  
 mirror polished finish, convenient handling  
 pulido brillante, manejo cómodo  
 brillant, manipulation aisée



	cm	€
00688 1	25 x 6,5	15,00



**Brot- und Gebäckzange**  
**bread and pastry tong**  
**pinza para pan y bollería**  
**pince à pain ou viennoiseries**



hochglanzpoliert, einfache Handhabung  
 mirror polished finish, convenient handling  
 pulido brillante, manejo cómodo  
 brillant, manipulation aisée



	cm	€
00686 7	25 x 6,5	15,00



**Brot- und Gebäckzange**  
**bread and pastry tong**  
**pinza para pan y bollería**  
**pince à pain ou viennoiseries**



hochglanzpoliert, einfache Handhabung  
 mirror polished finish, convenient handling  
 pulido brillante, manejo cómodo  
 brillant, manipulation aisée



	cm	€
00687 4	25 x 6,5	15,00

**Pfannenwender geschlitzt „CLASSIC“****turner**  
**espátula ranurada**  
**spatule rainurée**

	cm	→ cm	€
75910 7	9 x 8	33	8,80

**Schaumlöffel „CLASSIC“****skimmer**  
**espumadera**  
**écumoire**hochglanzpoliert, ergonomisch profilierter Hohl-Griff  
mirror polished finish, ergonomic designed handle  
pulido acabado brillante, mango ergonómico  
brillant, manche ergonomique

	cm	→ cm	€
75911 4	Ø 11	36	8,80

**Servierlöffel „CLASSIC“****serving spoon**  
**cuchara de servicio**  
**cuillère de service**hochglanzpoliert, ergonomisch profilierter Hohl-Griff  
mirror polished finish, ergonomic designed handle  
pulido brillante, asa ergonómica  
brillant, manche ergonomique

	cm	→ cm	€
75904 6	9 x 6	32,5	8,50

**Servierlöffel „CLASSIC“****spoon**  
**cuchara de servir agujereada**  
**cuillère de service ajourée**hochglanzpoliert, perforiert, Löcher Ø 4 mm, ergonomisch profilierter Hohl-Griff  
mirror polished finish, perforated, holes Ø 4 mm, ergonomic designed handle  
pulido brillante agujeros de Ø 4 mm, asa ergonómica  
brillant, trous Ø 4 mm, manche ergonomique

	cm	→ cm	€
75903 9	9 x 6	32	8,80

**Tranchiergabel „CLASSIC“****fork**  
**tenedor para carne**  
**fouchette à viande**hochglanzpoliert, ergonomisch profilierter Hohl-Griff, Zinkenlänge 8 cm  
mirror polished finish, ergonomic designed handle, length of prongs 8 cm  
pulido brillante, asa ergonómica, largo de las puas 8 cm  
brillant, manche ergonomique, dents long. 8 cm

	cm	→ cm	€
75905 3	8,5 x 2,5	32	7,80



**Salatgabel „CLASSIC“**  
**salad fork**  
**tenedor de servicio para ensalada**  
**fourchette de service pour la salade**



hochglanzpoliert, ergonomisch profilierter Hohl-Griff  
 mirror polished finish, ergonomic designed handle  
 pulido brillante, asa ergonómica  
 brillant, manche ergonomique

	cm	→ cm	€
75901 5	8 x 6	30	9,00



**Salatlöffel „CLASSIC“**  
**salad spoon**  
**cuchara para ensalada**  
**cuillère de service pour la salade**



hochglanzpoliert, ergonomisch profilierter Hohl-Griff  
 mirror polished finish, ergonomic designed handle  
 inox brillante, asa ergonómica  
 brillant, manche ergonomique

	cm	→ cm	€
75902 2	8 x 6	30	8,80



**Suppenkelle „CLASSIC“**  
**soup ladle**  
**cucharón de sopa**  
**louche de service**



hochglanzpoliert, ergonomisch profilierter Hohl-Griff  
 mirror polished finish, ergonomic designed handle  
 pulido brillante, asa ergonómica  
 brillant, manche ergonomique

	cm	→ cm	ltr.	€
75907 7	Ø 7	28	0,06	9,60



**Suppenkelle „CLASSIC“**  
**soup ladle**  
**cucharón de sopa**  
**louche de service**



hochglanzpoliert, ergonomisch profilierter Hohl-Griff  
 mirror polished finish, ergonomic designed handle  
 pulido brillante, asa ergonómica  
 brillant, manche ergonomique

	cm	→ cm	ltr.	€
75908 4	Ø 9	31	0,1	9,90





**Spaghettiheber „CLASSIC“**  
**spaghetti server**  
**tenedor espaguetis**  
**cuillère à spagettis**



hochglanzpoliert, ergonomisch profilierter Hohl-Griff  
 mirror polished finish, ergonomic designed handle  
 acabado brillante, asa ergonómica  
 brillant, manche ergonomique

	cm	→ cm	€
75909 1	8 x 6,5	32,5	9,40



**Saucengießlöffel „CLASSIC“**  
**sauce / gravy ladle**  
**cucharón de salsa**  
**cuillère à sauce**



hochglanzpoliert, ergonomisch profilierter Hohl-Griff, fugenlos  
 mirror polished finish, ergonomic designed handle, seamless  
 pulido brillante, asa ergonómica, sin soldadura  
 brillant, manche ergonomique, monobloc (sans soudure)

	cm	→ cm	ltr.	€
75906 0	7 x 5,5	28,5	0,02	8,20



**Tortennmesser „CLASSIC“**  
**cake slice**  
**porcionador de pastel**  
**couteau à tarte**



eine Kante gezahnt 15,5 cm  
 one edge serrated 15,5 cm  
 un borde serrado de 15,5 cm  
 denté sur un côté à 15,5 cm

	cm	→ cm	€
75912 1	4,5 x 1	29	9,60



**Tortenheber „CLASSIC“**  
**cake lifter**  
**pala de tartas**  
**pelle à gâteau**



hochglanzpoliert, mit einer gezahnten Kante, ergonomisch profilierter Hohl-Griff  
 mirror polished finish, one edge serrated, ergonomic designed handle  
 pulido brillante, canto dentado, mango ergonómico  
 brillant, bord microdenté, manche ergonomique

	cm	→ cm	€
75900 8	5 x 1	23	7,80



**Fischzange**  
**fish tong**  
**pinza de pescado**  
**pince pour le poisson**



hochglanzpoliert, längs perforiert  
 mirror polished finish, slotted  
 pulido brillante  
 brillant

	cm	→ cm	€
75802 5	10,5 x 3	24	6,90



**Grillzange  
barbecue tong  
pinza barbaocia  
pince à barbecue**



Edelstahl, mit schwarzem kunststoffummanteltem Griff  
black rubber coated handle  
asa revestida de goma negra  
poignée revêtue de résine noire

	cm	→ cm	€
75817 9	8 x 3,5	30,5	4,80



**Gebäck- / Tortenzange  
pastry tong  
pinza para pasteles  
pince à gâteaux**



hochglanzpoliert, fugenlos  
mirror polished finish, seamless  
acabado brillante, sin soldadura  
brillant, monobloc

	cm	→ cm	€
75803 2	7 x 3,5	17,5	4,90



**Gebäckzange  
pastry tong  
pinza para pasteles  
pince à gâteaux**



hochglanzpoliert, perforiert  
mirror polished finish, perforated  
pulido brillante, perforado  
brillant, perforée

	cm	→ cm	€
75804 9	6,5 x 3	19,5	7,80

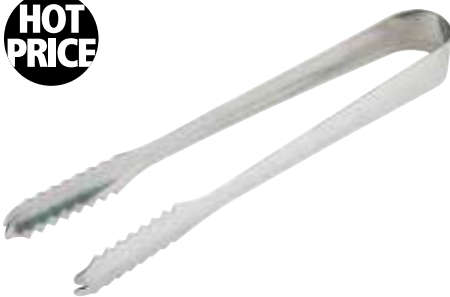

**Eiszange  
ice cube tong  
pinza para cubitos de hielo  
pince à glaçons**



hochglanzpoliert, fugenlos  
mirror polished finish, seamless  
pulido acabado brillante, de una sola pieza  
brillant, d'une seule pièce

	cm	→ cm	€
75805 6	5 x 2	17,5	2,00



**Allzweckzange  
multipurpose tong  
pinza multi-usos  
pince universelle multi-usages**



	cm	→ cm	€
88643 8	4 x 3	24	2,90
88644 5	4 x 3	30	3,60
88645 2	4 x 3	40	3,90



**Aufschnitt- / Allzweckzange**  
**sausage tong**  
**pinza salchichas**  
**pince à saucisses**



hochglanzpoliert, fugenlos  
mirror polished finish, seamless  
pulido brillante, sin soldadura  
brillant, monobloc

	cm	→ cm	€
75806 3	3 x 2,5	16	3,60



**Gebäckzange**  
**pastry tong**  
**pinza para pasteles**  
**pince à gâteaux**



hochglanzpoliert, fugenlos, extra schwere Qualität  
mirror polished finish, seamless, extra heavy gauge  
pulido brillante, sin soldadura, alta calidad, resistente  
brillant, monobloc, qualité extra, robuste

	cm	→ cm	€
75807 0	8,5 x 4	27,5	8,90



**Universalzange**  
**general tong**  
**pinza universal**  
**pince universelle**



hochglanzpoliert, einseitig geschlitzt  
mirror polished finish, slotted on one side  
acabado brillante, agujereada en un lado  
brillant, perforée d'un seul côté

	cm	→ cm	€
75800 1	5 x 2	24	4,50



**Salatzange**  
**salad tong**  
**pinza ensalada**  
**pince à salade**



hochglanzpoliert, beidseitig geschlitzt  
mirror polished finish, slotted on both side  
acabado brillante, agujereada en 2 lados  
brillant, perforéedes 2 côtés

	cm	→ cm	€
75801 8	5 x 2	24	5,80



**Spaghettizange**  
**spaghetti tong**  
**pinza espaguetis**  
**pince à spaghettis**



hochglanzpoliert, fugenlos  
 mirror polished finish, seamless  
 acabado brillante, sin soldaduras  
 brillant, monobloc

	cm	→ cm	€
75810 0	6 x 3	19	4,30

**ideal zum**  
**Grätenziehen**  
**oder Garnieren**  
**von edlen Speisen**



**Pinzettenzange**  
**fine tong / tweezer**  
**pinza de emplatar**  
**pince à dresser**



hochglanzpoliert, geriffelte Grifffläche, abgerundete Spitzen vorne, schwere Qualität  
 mirror polished finish, ribbed handle, rounded on the tops, heavy gauge  
 acabado brillante, mango cómodo ranurado, alta calidad, puntas redondeadas  
 brillant, manche rainuré antiglisse, qualité extra, pointes arrondies

	cm	→ cm	€
75808 7	1 x 1	14,5	5,00

**ideal zum**  
**Grätenziehen**  
**oder Garnieren**  
**von edlen Speisen**



**Pinzettenzange**  
**fine tong / tweezer**  
**pinza de emplatar**  
**pince à dresser**



hochglanzpoliert, geriffelte Grifffläche, schwere Qualität  
 mirror polished finish, ribbed handle, heavy gauge  
 acabado brillante, mango cómodo ranurado, alta calidad  
 brillant, manche rainuré antiglisse, qualité extra

	cm	→ cm	€
75809 4	1,5 x 1	30	7,80



**Zitronenschnitzelpresse**  
**lemon slice squeezer**  
**pinza exprimelimon**  
**pince presse-citron**



hochglanzpoliert, zum Auspressen von Zitronenscheiben  
 mirror polished finish, to press lemon slices  
 pulido brillante, para rodajas de limón  
 brillant, pour citrons en rondelle

	cm	€
71430 4	8 x 7	1,20



**Mehrweckschaufel**  
**scoop**  
**pala universal**  
**pelle multi-usages**



	□ cm	→ cm	€
93195 4	Ø 6	24	8,60
93196 1	Ø 8	26	13,00



**Eis- / Mehrweckschaufel**  
**scoop**  
**pala universal**  
**pelle multi-usages**



hochglanzpoliert, Hohlgriff, fugenlos verbunden mit Schaufel, extra schwere Qualität  
 mirror polished finish, hollow handle, seamless fixed, extra heavy gauge  
 brillante, mango hueco, sin soldadura con gancho, muy resistente  
 brillant, manche creux, monobloc, avec crochet, très robuste

	□ cm	→ cm	ltr.	€
71009 2	8,5 x 4,3	17,5	0,05	7,40
71010 8	9,5 x 5,9	21,5	0,07	8,20
71011 5	12 x 6	23	0,14	9,70
71012 2	14 x 7,5	23,5	0,24	10,80
71013 9	15,5 x 8,5	24,5	0,30	10,90
71014 6	18 x 10	29	0,36	13,90
71015 3	22 x 13	35	0,47	16,80



**Mehlschaufel**  
**scoop**  
**pala**  
**pelle à farine**



stehende Schaufel, auch für Flüssigkeiten geeignet  
 standing scoop, also applicable for liquids  
 pala, ápto también para líquidos  
 adaptée pour poudres et liquides

	□ cm	↑ cm	ltr.	€
00610 2	25 x 9	4,5	0,25	2,30
00611 9	31 x 12	5,5	0,5	2,80
00612 6	35 x 13	6	0,7	4,10



**Eisschaufel**  
**ice scoop**  
**pala para cubitos de hielo**  
**pelle à glaçons**



	□ cm	→ cm	ltr.	€
93192 3	10 x 6	29	0,7	7,80

**HOT  
PRICE**



**Feinkostlöffel, 6er Set**  
delicatessen spoon, 6 pcs. set  
juego de 6 cucharas gourmet  
jeu de 6 cuillères gourmet

**SAN**  
KUNSTSTOFF



	cm	→ cm	pcs.	€
88626 1	Ø 6	23	6	8,20

**HOT  
PRICE**



**Feinkostlöffel, 6er Set**  
delicatessen spoon, 6 pcs. set  
juego de 6 cucharas gourmet  
jeu de 6 cuillères gourmet

**SAN**  
KUNSTSTOFF



	cm	→ cm	pcs.	€
88627 8	Ø 6	23	6	8,20

**HOT  
PRICE**



**Feinkostlöffel, 6er Set**  
delicatessen spoon, 6 pcs. set  
juego de 6 cucharas gourmet  
jeu de 6 cuillères gourmet

**SAN**  
KUNSTSTOFF



	cm	→ cm	pcs.	€
88628 5	Ø 6	23	6	8,20

**HOT  
PRICE**



**Feinkost- / Olivenlöffel, 6er Set**  
delicatessen / olives spoon, 6 pcs. set  
juego de 6 cucharas para olivas  
jeu de 6 cuillères à olives

**SAN**  
KUNSTSTOFF



gelocht  
perforated  
perforadas  
perforées

	cm	→ cm	pcs.	€
88598 1	6 x 9	27	6	10,00

**HOT  
PRICE**



**Dressinglöffel**  
dressing spoon  
cuchara de aliño  
cuillère à sauce

**SAN**  
KUNSTSTOFF



	cm	→ cm	€
88609 4	Ø 6	34	3,30
88636 0	Ø 6	34	3,30



# QUALITÄTSHAUBEN



11041  
GN1/2

11042  
GN1/1



11041  
GN1/2



11042  
GN1/1

**Abdeckhaube GN**  
**cover GN**  
**cubierta GN**  
**cloche GN**



passend für GN Tablett, glasklarer Kunststoff, nahezu unzerbrechlich

suitable for GN trays, clear plastic, nearly unbreakable

apto para bandejas GN, plástico transparente, muy resistente a la rotura, resistencia hasta 60°C

pour bacs et plateaux GN, plastique transparent, très résistant à la casse, température maxi +60°C

	cm	cm	GN	Materialstärke mm	€
11041 0	32,5 x 26,5	9,5	1/2	3	19,00
11042 7	53,0 x 32,5	9,5	1/1	3	27,00

**Haube GN1/1 „HOCHSTAPLER“**  
**cover GN1/1 high stacker**  
**campana GN1/1 especial para apilar**  
**cloche GN1/1 spéciale empilage**



glasklarer Kunststoff, passend zum Tablett 11300, 11290, 11295, Tablett fixiert sich auf der Haube - kein Rutschen möglich, nahezu bruchfest

clear plastic, for tray 11300, 11290, 11295, tray fixes itself on the cover and can not slip off, nearly unbreakable

plástico transparente para bandejas 11300, 11290, 11295, la bandeja se fija a la tapa para que no se deslice, muy resistente a la rotura

en plastique transparent pour plats 11300, 11290, 11295, le plat se fixe sur le dessous de la cloche pour ne pas glisser, très résistant à la casse

	cm	cm	GN	€
11305 3	53 x 32,5	9	1/1	30,00



designed by **CULTURE FORM**

**PATENT**



**Rolltop-Haube „PURE“**  
rolltop cover  
campana abatible  
cloche basculante

verchromter Griff  
chrome plated handle  
pomo cromado  
bouton chromé



	cm	cm	€
09013 2	44 x 33,5	17	24,00

**PATENT**



**GN1/1 oder GN1/2**

**Rolltop-Haube GN1/1**  
rolltop cover  
campana rolltop  
cloche rolltop

patentiert, passend für GN-Behälter, -Tablets, etc., leichtgängig auf- und zuklappbar 90°, temperaturbeständig -30°C bis ca. 120°C  
patented, suitable for GN trays, solid quality, 90° opening, heat-resistant -30°C to 120°C  
patentada, para bandejas GN, apertura 90°, temperatura -30°C a +120°C  
brevetée, pour plateaux GN, ouverture 90°, température -30°C à +120°C



	cm	cm		€
11008 3	53,0 x 32,5	19	vergoldeter Griff / gold plated handle pomo dorado / bouton doré	59,90
11010 6	53,0 x 32,5	19	verchromter Griff / chrome plated handle pomo cromado / bouton chromé	59,90
12008 2	32,5 x 26,5	15	vergoldeter Griff / gold plated handle pomo dorado / bouton doré	54,20
12010 5	32,5 x 26,5	15	verchromter Griff / chrome plated handle pomo cromado / bouton chromé	54,20

designed by **KIRCHHOFF & EUWENS**

**PATENT**



**Rolltop-Haube GN1/1 „SUNDAY“**  
rolltop cover GN1/1  
campana rolltop GN1/1  
cloche rolltop GN1/1

patentiert, mit Designer-Griff, ABS verchromt, leichtgängig auf- und zuklappbar  
patent, with designer handle, chrome plated, easy to open and close  
campana sola, policarbonato, asa cromada, fácil de abrir y cerrar  
cloche seule, polycarbonate, bouton chromé, ouverture et fermeture faciles



	cm	cm	GN	€
11016 8	53,0 x 32,5	19	1/1	62,00



**bruchfest**

**klappbar**

**Haube GN1/1**  
cover GN1/1  
campana GN1/1  
cloche GN1/1

klappbar, passend für GN1/1-Behälter, GN1/1-Tablets, etc., nahezu bruchfest  
suitable for GN1/1 chafing dish, GN1/1 trays, GN1/1 pans  
para chafing dish GN1/1, bandejas GN1/1, cubetas GN1/1  
pour chafing dish, plateau, bac ou corbeille GN1/1



	cm	cm	GN	€
11013 7	53 x 32,5	6	1/1	27,50

**Rolltop-Haube**  
**rolltop cover**  
**campana abatible**  
**cloche basculante**



glasklarer Kunststoff, leichtgängig auf- und zuklappen 90°  
 solid quality, to be opened 90°  
 plástico transparente de alta calidad, apertura a 90°  
 plastique transparent résistant, ouverture 90°

**passend für alle APS-Tablets mit Ø 38 cm**  
**suitable for APS trays Ø 38 cm**  
**apta para todas las bandejas APS de Ø 38 cm**  
**pour tous les plateaux APS de Ø 38 cm**

	□ cm	↑ cm		€
18387 2	Ø 38	20	mit <b>vergoldetem</b> Kugelgriff gold plated handle pomo dorado bouton doré	19,40
18388 9	Ø 38	20	mit <b>verchromtem</b> Kugelgriff with chrome plated handle con pomo cromado avec bouton chromé	19,40



	□ cm	↑ cm		€
18380 3	Ø 50	26	mit <b>verchromtem</b> Zylindergriff chrome plated handle pomo cromado bouton chromé	54,00
18381 0	Ø 50	26	mit <b>verchromtem</b> Kreuzgriff chrome plated handle pomo cromado bouton chromé	54,00
18383 4	Ø 50	26	mit <b>vergoldetem</b> Kreuzgriff gold plated handle pomo dorado bouton doré	54,00

designed by **sieger design**

**Frischhalte-Haube**  
**cover**  
**campana**  
**cloche bombée**



glasklar, Griff verchromt, schwere stabile Ausführung  
 transparent, chrome knob, heavy stable quality  
 transparente, asa cromada, alta estabilidad  
 transparente, anse chromée, très stable

	□ cm	↑ cm	passend für / suitable for	€
15350 9	Ø 16,5	10	15130	10,00
15351 6	Ø 20,5	10	15131, 15141, 15136, 15271, 84241	12,00

**2 Größen / 2 sizes**  
**3 mm Materialstärke**



Ø 30 cm  
und  
Ø 33 cm



**Frischhalte-Haube**  
cover  
campana  
cloche



glasklar, schwere stabile Ausführung, stapelbar  
clear, heavy stable quality, stackable  
transparente, alta estabilidad, apilable  
transparente, très stable, empilable

	☐ cm	↑ cm		€
06510	9 Ø 30	11,5		4,40
06511	6 Ø 30	11,5	schwarzer Griff / black handle botón negro / bouton noir	5,50
06512	3 Ø 30	11,5	mit verchromtem Griff chrom plated handle botón cromado bouton chromé	5,90
06515	4 Ø 33	12,5		5,50
06516	1 Ø 33	12,5	schwarzer Griff / black handle botón negro / bouton noir	6,50
06517	8 Ø 33	12,5	mit verchromtem Griff chrom plated handle botón cromado bouton chromé	6,90



stapelbar



**Frischhalte-Haube**  
cover  
campana  
cloche



	☐ cm	↑ cm		€
06501	7 Ø 30	11		2,90
06504	8 Ø 30	9,5		4,90
06506	2 Ø 30	7		2,90



**Frischhaltehauben, 2er Set**  
covers, 2 pcs. set  
2 campanas  
set de 2 cloches



vielseitig einsetzbar, einzeln mit Farbbänderole  
multifunctional usable  
uso multifunción, -40° hasta + 95°C  
multi-usages, -40° à + 95°C

	☐ cm	↑ cm		€
40752	7 Ø 30	11		5,90



designed by **CULTURE FORM**



**GN Kuppelhaube**  
**GN cover**  
**GN cúpula**  
**GN cloche bombée**



glasklarer Kunststoff, Griff verchromt  
 clear, chrome knob  
 transparente, asa cromada  
 transparente, anse chromée



	▣ cm	↑ cm		€
11021 2 GN1/2	33 x 28	17	geschlossen / totally closed cerrada / totement fermée	22,00
11022 9 GN1/2	33 x 28	17	mit Front-Ausschnitt / one long side cut out gran apertura frontal / grande ouverture frontale	24,00
11026 7 GN1/1	54 x 33	20	geschlossen / totally closed cerrada / totement fermée	47,00
11027 4 GN1/1	54 x 33	20	mit Front-Ausschnitt / one long side cut out gran apertura frontal / grande ouverture frontale	49,00
11028 1 GN1/1	54 x 33	20	mit seitlichem Ausschnitt / one small side cut out pequeña apertura lateral / petite ouverture latérale	49,00

**Deckel „PURE“, mit Löffelaussparung**  
**cover, with notched for spoons**  
**tapa, con espacio para la cuchara**  
**couvercle, avec encoche pour la louche**



	□ cm	↑ cm	passend für / suitable for	€
83600 6	19 x 19	1,5	Schale / bowls „PURE“ 84410, 84417, 84422, 83409 83572, 83468, 83573, 84429	8,00
83601 3	25 x 25	1,5	Schale / bowls „PURE“ 84408, 84418, 84423, 83469, 83574, 83575, 83408, 84430	10,50



glasklar / clear / transparent

ergonomischer Griff

**Frischhaltedeckel**  
**airtight cover**  
**tapa hermética**  
**couvercle hermétique**



mit Silikondichtung, für luftdichtes Verschließen, Lebensmittel bleiben lange frisch  
with silicone sealing ring, bowls closed airtight, to keep food fresh for a long time  
junta de silicona para cerrar herméticamente los boles y mantener los alimentos frescos más tiempo  
joint silicone pour fermeture hermétique et meilleure conservation des aliments



	□ cm	€
10890 5	Ø 14	10,50
passend für Schalen 11865, 83700, 83701 suitable for bowls 11865, 83700, 83701 disponible para boles 11865, 83700, 83701 disponible pour bols 11865, 83700, 83701		
10887 5	Ø 23	19,00
passend für Schalen 11875, 11846, 11848, 83702, 83703 suitable for bowls 11875, 11846, 11848, 83702, 83703 disponible para boles 11875, 11846, 11848, 83703 disponible pour bols 11875, 11846, 11848, 83703		

designed by **KIRCHHOFF & EUWENS**

**Deckel klappbar**  
**cover hinged**  
**tapa con bisagra**  
**couvercle avec charnière**



glasklar, mit Designer-Griff, verchromt, ohne Beschriftungsschild  
clear, with designer handle, chrome plated, without card for inscription  
transparente, con pomo de diseño cromado, sin tarjetas para inscripción  
transparent, avec bouton chromé de design, sans étiquette pour inscription



	□ cm	€
10889 9	Ø 23,5	10,50

**Schutzdeckel**  
cover  
tapa  
couvercle



11868



11878

glasklar, klappbar, mit Beschriftungs-Schild  
transparent, with card for inscription  
plástico transparente, con etiqueta para inscripción  
plastique transparent, avec étiquette pour inscription

	cm		€
11867 6	Ø 14,5	mit vergoldetem Griff / gold plated handle botón dorado / bouton doré	11,40
11868 3	Ø 14,5	mit verchromtem Griff / chrome plated handle botón cromado / bouton chromé	10,40
11877 5	Ø 23,5	mit vergoldetem Griff / gold plated handle botón dorado / bouton doré	12,50
11878 2	Ø 23,5	mit verchromtem Griff / chrome plated handle botón cromado / bouton chromé	11,40

**Einzelteile / spare parts / piezas sueltas / pièces détachées**

passende Schilder, 10er Set / fitting signs, 10 pcs. set  
set de 10 cartelitos / set de 10 étiquettes

11879 9	für große Deckel / for big covers para tapas grandes / pour grands couvercles	4,90
12879 8	für kleine Deckel / for small covers para tapas pequeñas / pour petits couvercles	4,60



**Schale**  
bowl  
cuenco  
bol



	cm	cm	ltr.	VE / Unit	€ / pc.
11859 1	Ø 6	2,5	0,05	36	1,30
11865 2	Ø 14	6,5	0,5	6	2,20
11866 9	Ø 7,5	3,5	0,09	36	1,40
11875 1	Ø 23	10,5	2,5	6	4,20

**Kühlakku**  
cooler  
acumulador de frío  
accumulateur de froid



gefüllt mit Kühlflüssigkeit, nicht giftig, einfach im Gefrierfach einfrieren, unbegrenzt wiederverwendbar

freeze it in freezer, non toxic, filled with freezer-liquid, boundless reusable

se enfría en el congelador, no tóxico, se puede reutilizar sin límite

liquide eutectique qui accumule froid une fois dans le congélateur, non toxique, réutilisable sans limites



	cm	cm		€
10777 9	Ø 15	2,5	○	5,00
10779 3	25 x 19	2,5	●	7,40
10791 5	25 x 19	2,5	○	7,20
10781 6	Ø 10,5	2,5	○	3,00
10782 3	41 x 21	2,5	○	14,20
10661 1	Ø 10,5	2,0	○	3,20

ohne Abbildungen / without pictures / no fotografiado / fotos não estão disponíveis

	cm	cm	pcs.	€
11101 1	16 x 7,5	2,0	4 ●	4,70
10752 6	Ø 10,5	2,0	●	4,60

# Index

## 0

00013	367	00401	409	00687	494	00990	148, 192	466, 507	272, 510	11220	163, 224	11680	284
00015	442	00444	174	00688	494	00991	148, 194	06506	507	10778	228	11683	291
00016	442	00462	175, 465	00691	140	00992	148	06510	120, 167, 174, 465, 507	10779	244, 245, 246, 248, 510	11685	284
00017	367	00463	174, 465	00692	140	00993	148, 195	06511	120, 507	10781	197, 510	11686	283
00019	439	00464	174	00700	371	00994	148	06512	23, 25, 68, 120, 507	10782	203, 225, 510	11692	283
00020	439	00466	174, 465	00710	317, 489	00995	148	06515	94, 167, 507	10787	261	11693	294
00021	371	00468	120, 175, 466	00711	317, 489	00996	148	06516	94, 507	10788	263	11695	283
00022	369	00469	120, 175, 466	00712	317, 489	00997	150	06517	25, 29, 68, 94, 174, 465, 507	10789	263	11696	284
00023	371	00500	184	00713	317, 489	00998	150	06701	167, 176	10791	237, 510	11699	284
00024	441	00501	184	00714	317, 489	00999	150	08201	165	10793	268	11720	436
00025	439	00502	183	00715	317, 489	01000	151	09000	237	10794	268	11730	437
00026	439	00503	183	00716	317, 489	01309	166	09001	237	10795	268	11762	437
00027	439	00505	183	00717	317, 489	01310	166	09002	237	10796	268	11763	437
00028	439	00506	184	00720	317, 489	01311	166	09003	237	10797	268	11765	437
00029	439	00507	184	00721	317, 489	01312	166	09004	237	10798	268	11766	437
00030	370	00508	183	00722	317, 489	01313	166	09005	237	10799	268	11775	434
00031	443	00509	183	00723	317, 489	01314	166	09010	237	10800	264	11776	434
00032	179	00510	182	00730	317, 489	01317	166	09011	237	10801	272	11777	436
00033	431	00511	182	00740	490	01318	166	09012	237	10802	272	11778	436
00034	369	00512	182	00744	490	01322	166	09013	237, 505	10803	272	11780	436
00036	370	00513	182	00745	490	01323	166	09016	237	10804	272	11784	225
00037	369	00515	182	00746	490	01324	166	09020	237	10805	266, 267	11795	225
00038	368	00521	185	00747	490	01325	166	09021	237	10806	266, 267	11805	227
00039	368	00522	185	00765	420	01328	172	09022	237	10807	272	11807	227
00040	463	00523	185	00766	420	01332	166	09023	237	10808	272	11808	227, 230
00042	463	00524	185	00768	420	01335	166	09026	237	10809	272	11810	251
00043	363	00525	185	00770	450	01336	173, 352	09028	237	10810	268	11811	251
00044	363	00526	185	00771	450	01338	166	09080	240	10812	272	11812	251
00045	466	00527	185	00772	427	01348	166	09081	241	10814	272	11813	251
00046	175, 466	00528	185	00773	426	01349	166	09082	249	10820	265	11815	251
00048	362	00529	185	00774	426	01358	166	09083	249	10825	269	11816	251
00050	362	00530	183	00775	426	01415	162	09085	240	10830	270	11817	250
00051	361	00531	183	00776	426	01416	162	09090	242	10833	270	11818	250
00052	362	00532	183	00777	426	01420	162	09093	243	10835	270	11833	229
00053	440	00533	183	00778	426	01425	162	09099	240	10840	269	11834	229
00054	361	00535	183	00779	427	01437	163	09100	242	10850	269	11845	252
00055	361	00536	183	00780	458	01496	204	09102	242	10859	269	11846	252, 252
00058	443	00537	183	00781	427	01699	188	09104	242	10860	266	11847	252
00059	431	00538	183	00782	427	01709	166	09200	243	10862	267	11848	250, 252
00060	367	00540	183	00783	427	01710	166	09202	243	10864	267	11849	252
00062	178	00541	183	00785	451	01711	166	09204	243	10865	266	11859	510
00063	178	00543	183	00831	316, 484	01712	166	09923	107	10867	266, 267	11865	203, 223, 510
00064	167, 176	00544	183	00832	316, 484	01723	166	09924	107	10870	198, 271	11866	510
00065	168, 176	00547	182	00833	316, 484	01725	166	1		10871	198, 271	11867	223, 510
00066	167, 176	00548	182	00834	316, 484	01738	166	10316	430	10872	198, 271	11868	223, 251, 510
00069	366	00549	182	00860	144, 172, 238	01748	166	10317	430	10873	198, 271	11875	203, 222, 252, 510
00070	372	00550	184	00861	144, 238	02038	443	10318	430	10887	197, 203, 509	11877	222, 510
00071	370	00551	184	00862	144, 238	02310	168	10319	430	10889	509	11878	222, 250, 252, 510
00073	431	00552	183	00863	144, 238	02311	168	10320	430	10890	197, 203, 509	11879	133, 367, 368, 510
00074	371	00553	183	00865	143, 239	02312	168	10321	430	10907	269	11881	468
00075	164	00554	183	00866	143, 239	03012	379	10322	432	10910	445	11884	258
00076	372	00555	183	00867	142	03013	378	10323	432	10911	445	11885	258
00077	369	00572	367	00868	142	03014	378	10325	432	10912	445	11887	259
00078	369	00573	367	00869	142	03015	378	10326	432	10913	445	11888	259
00079	369	00574	364	00870	143	03016	379	10327	432	10914	445	11889	259
00081	164	00575	365	00871	143	03020	379	10328	429	10915	446	11891	259
00082	164	00576	363	00872	143	03025	379	10329	429	10916	446	11892	289
00084	164	00579	364	00873	143	03026	378	10330	429	10917	446	11901	289
00085	164	00580	365	00874	143	03027	378	10331	429	10921	444	11902	289
00086	164	00581	443	00875	143	03028	379	10332	429	10922	444	11910	290
00087	164	00582	361	00876	143	03033	378	10334	429	10923	444	11911	290
00088	164	00583	361	00877	143	03038	380	10335	429	10924	444	11912	290
00089	164	00584	361	00880	142	03039	380	10336	429	11000	158	11913	290
00090	362	00585	361	00881	142	03098	380	10608	272	11001	254	11915	290
00091	362	00600	485	00882	142	03099	380	10661	251, 510	11008	143, 239, 244, 248, 254, 394, 505	11916	290
00092	454	00601	486	00883	257	03610	372	10663	270	11013	505	11917	290
00093	454	00602	486	00884	257	03611	372	10668	228	11015	254	11919	290
00094	454	00603	485	00885	257	03614	212	10700	264	11016	143, 225, 239, 505	11920	292
00095	454	00604	485	00901	248	03615	212	10701	272	11017	254	11921	310
00096	454	00605	486	00929	153	03616	212	10703	272	11018	203	11922	310
00097	454	00606	486	00930	153	03617	212	10704	272	11019	254	11923	310
00098	454	00607	486	00931	153	03618	212	10707	272	11020	158	11925	438
00099	454	00610	501	00932	153	03619	212	10708	272	11021	394, 508	11927	309, 438
00100	291	00611	501	00935	150	03620	212	10709	272	11022	394, 508	11930	440
00105	455	00612	501	00936	150	03621	212	10710	272	11023	158	11931	440
00106	455	00615	328	00937	150	03622	211	10711	272	11024	158	11940	311
00107	455	00616	328	00938	150	03623	211	10712	272	11025	158	11941	311
00108	455	00617	328	00939	150	03814	164	10713	272	11026	394, 508	11942	311
00110	454	00618	328	00941	149	03824	164	10714	272	11027	393, 394, 508	11943	311
00111	360	00619	328	00942	149	04000	377	10715	272	11028	394, 508	11945	315
00113	454	00620	328	00945	149	04001	376	10716	272	11032	158	11946	315
00114	454	00621	328	00950	257	04002	376	10717	272	11038	158	11947	315
00116	454	00623	188	00951	257	04003	376	10718	272	11040	158	11950	308
00193	218	00625	188	00952	257	04004	376	10720	264	11041	160, 504	11951	311
00208	291	00626	188	00953	256	04005	376	10730	265	11042	160, 504	11952	311
00215	442	00627	188	00954	256	04006	376	10740	265	11044	158	11953	308
00216	442	00630	354	00955	257	04008	375	10750	270	11045	158	11955	311
00291	441	00632	354	00956	257	04012	377	10752	261	11048	158	11956	308
00292	441	00635	430	00957	257	04013	377	10753	261	11050	158	11957	308
00311	443	00636	258, 46										

11992	234	13960	202	15235	20	15462	39	30110	181	33271	209	40146	392	40440	414
11993	234	13965	227	15236	30	15463	39	30111	187, 432	33272	210	40148	254, 392, 394	40441	414, 415
11994	309	13966	207	15250	31	15464	39	30112	187, 432	33273	210	40149	393	40442	412, 413
11996	309	13980	197	15251	31	15465	39	30113	187, 432	33274	210	40150	394	40443	419
11997	309	13981	197	15252	31	15466	39	30114	170, 187	33275	210	40152	392	40444	419
11998	309	13985	199	15253	31	15467	39	30115	187, 432	33276	210	40153	393	40450	414
11999	309	13987	198, 229	15255	27	15468	39	30116	187, 432	33277	210	40154	253, 254, 395	40453	418
12000	158	13990	196	15256	27	15469	39	30117	187, 432	33280	210	40159	253, 392, 395	40454	418
12008	505	13995	199	15257	27	15470	39	30118	187	33281	210	40160	392	40455	417
12010	505	14910	205	15258	27	15471	39	30119	186	34247	114, 217	40161	253, 392, 395	40457	417
12040	158	14911	205	15259	27	15472	39	30120	106	34248	114, 217	40179	396	40458	417
12065	158	14915	205	15261	27	15473	39	30121	106	35050	296	40182	396	40460	417
12100	158	14916	205	15262	27	15474	39	30122	106	35065	296	40191	392	40461	416, 417
12221	287	14920	205	15263	27	15475	39	30123	187, 432	35070	296	40192	392	40462	416, 417
12222	288	14921	205	15270	23	15476	39	30124	187, 432	35343	296	40193	392	40463	417
12225	288	14925	205	15271	23	15477	39	30126	186, 432	35350	296	40194	392	40464	417
12228	288	14926	205	15272	23	15478	39	30127	186, 432	35711	181	40195	392	40470	416
12232	287	14930	204	15300	29	15479	39	30136	186, 432	35712	181	40196	392	40472	416
12233	281	14931	204	15301	29	15480	39	30137	186, 432	35720	180	40198	396	40474	416
12235	288	14935	204	15302	29	15481	39	30200	402	35730	180	40199	396	40476	416
12236	281	14940	202	15303	29	15482	39	30201	403	35734	180	40200	177	40478	416
12240	281	14941	202	15310	29	15483	39	30202	403	35735	180	40201	177	40480	416
12243	289	14942	202	15311	29	15484	39	30203	401	35912	181	40202	177	40482	418
12244	289	14950	203	15312	29	15485	39	30204	401	35930	180	40203	177	40485	419
12245	281	14951	203	15313	29	15486	39	30210	402	36002	330	40204	177	40486	421
12249	279, 280, 281	14952	203	15320	33	15487	39	30220	402	36003	322, 335, 350	40205	177	40487	421
12260	281	14953	206	15321	33	15488	39	30230	402	36004	322, 335, 350	40206	177	40488	421
12285	292	14954	206	15322	33	15489	39	30240	402	36007	340	40207	177	40490	420
12287	285, 293	14956	206	15323	33	15490	39	30250	402	36009	336	40208	177	40494	420
12290	280, 293	14965	227	15324	33	15491	39	30260	457	36010	341	40210	399	40498	420
12291	277, 278, 292	14966	207	15325	33	15492	39	30261	457	36011	341	40211	399	40499	420
12292	280, 293	14970	206	15326	33	15493	39	30263	457	36012	350	40212	399	40500	428
12294	280, 293	14980	197	15331	33	15494	39	30264	457	36013	334	40213	399	40501	428
12295	274, 275, 276, 277, 278, 292	14981	197	15332	33	15495	39	30266	457	36014	348	40214	399	40503	428
		14985	199	15334	33	15496	39	30267	457	36015	334	40215	399	40504	428
		14987	198, 229	15335	33	15497	40	30270	402	36017	336	40216	399	40505	428
12299	293	14990	196	15340	21, 36	15498	40	30272	402	36019	348	40220	391	40506	421
12300	282	14995	199	15341	21, 36	15499	40	30276	403	36020	322	40222	253, 391, 395	40507	428
12310	288	15100	19	15342	21, 36	15500	40	30277	403	36021	322	40223	390	40508	420
12320	280	15101	19	15343	21, 36	15501	43	30279	398	36022	334	40224	391	40520	423
12321	280	15102	19	15344	21, 36	15502	43	30280	398	36024	334	40225	390	40521	423
12340	286	15103	19	15345	21	15503	43	30281	398	36025	322	40226	391	40522	423
12350	279	15104	19	15346	21	15504	43	30282	398	36026	321	40227	390	40524	423
12352	274	15105	19	15347	21	15505	43	30283	398	36027	334	40228	391	40530	423
12353	275	15106	19	15348	21	15506	43	30284	398	36028	321	40229	390	40531	423
12354	275	15107	19	15350	25, 68, 506	15507	42	30285	398	36029	334	40230	391	40532	423
12355	286	15108	19	15351	23, 25, 68, 506	15508	42	30286	253, 395, 398	36030	330	40234	399	40534	423
12356	286	15110	19	506		15509	42	30287	398	36032	332	40235	399	40535	424
12357	286	15111	19	15400	36	15510	42	30288	253, 395, 398	36033	335	40236	399	40536	424
12360	287	15112	19	15401	36	15511	42	30299	179, 400	36034	332	40237	399	40537	424
12366	275, 278	15113	19	15402	36	15512	42	30310	403	36036	331	40240	212, 391	40540	423
12370	274	15114	19	15403	36	15513	43, 211	30320	403	36037	335	40242	253, 391, 395	40541	423
12371	275	15115	19	15404	36	15514	43, 211	30325	218	36038	330	40243	390	40542	423
12372	275	15116	19	15405	36	15921	178	30332	323	36042	331	40244	391	40543	423
12385	278	15117	19	15406	36	15925	178	30333	360	36044	325	40245	390	40544	425
12386	276	15120	30	15407	36	15926	178	30340	401	36045	325	40246	391	40545	425
12390	278	15125	31	15408	36	17910	202	30341	401	36046	325	40247	390	40546	424
12391	276	15126	31	15409	36	17920	204	30342	400	36047	325	40248	391	40547	424
12393	278	15127	31	15410	36	17921	204	30343	400	36048	327	40249	390	40548	424
12394	276	15128	31	15411	36	17922	203	30350	401	36049	326	40250	391	40600	136
12396	277	15130	25, 176, 466	15412	36	18380	143, 239, 506	30351	401	36050	331	40260	391	40601	136
12397	275, 277	15131	25, 176, 466	15413	36	18381	506	30352	400	36052	327	40262	253, 391, 395	40602	137
12398	277	15132	25, 176, 466	15414	36	18383	506	30353	400	36053	327	40263	391	40603	137
12399	277	15133	25, 176, 466	15415	36	18387	245, 393, 506	30360	401	36054	327	40264	391	40605	138
12403	278	15135	23	15416	36	18388	25, 29, 120, 144, 238, 241, 245, 247, 249, 393, 506	30361	401	36055	326	40266	391	40606	138
12404	276	15136	23	15417	36			30362	400	36056	326	40268	391	40607	138
12415	207	15137	23	15418	36			30363	400	36057	326	40270	212, 391	40610	136
12483	279	15140	22	15419	36	18389	203	30370	401	36062	329	40272	253, 391, 395	40611	136
12484	279	15141	22	15420	36			30371	401	36063	329	40274	391	40612	137
12879	133, 367, 368, 510	15142	22	15421	36	18394	241	30372	400	36065	325	40276	391	40613	137
		15422	36	15422	36			30373	400	36066	320	40278	391	40616	138
12910	205	15151	27	15423	36	23642	168	30380	401	36068	323	40280	391	40617	138
12911	205	15152	27	15424	37	24330	213	30385	401	36069	323	40286	397	40618	138
12915	205	15160	25	15425	37	24331	213	30390	401	36071	327	40287	397	40620	136
12916	205	15165	28	15426	37	24332	213	33210	207	36072	327	40290	205, 390	40621	136
12920	205	15166	28	15427	37	24334	213	33211	215	36073	327	40291	205, 390	40622	137
12921	205	15167	28	15428	37	24335	213	33212	215	36074	330	40292	205, 390	40623	137
12925	205	15200	21	15429	37	24336	213	33214	214	36075	332	40293	205, 390	40630	139
12926	205	15201	21	15430	37	24338	213	33215	215	36076	324	40294	205	40631	139
12940	202	15202	21	15431	37	24339	213	33216	214	36077	199, 324	40295	205	40632	145
12941	202	15203	21	15432	37			33217	214	36078	320	40296	237, 385	40633	145
12942	202														



49638	313	60033	408	71450	367	75911	495	81997	301	83311	190	83630	89	83798	112
49738	313	60034	408	71451	367	75912	497	81998	301	83400	103	83631	89	83799	90
5		60035	408	71452	367	77302	463	81999	301	83401	102	83633	89	83800	95
50002	219	60036	408	71453	367	77304	463	82001	129, 304	83402	103	83634	89	83801	118, 282
50100	383	60037	408	71454	367	77305	463	82003	304	83403	103	83636	89	83802	95
50105	383	60038	408	71455	367	77322	462	82004	304	83404	103	83637	89	83803	118, 282
50110	383	60039	408	71460	371	77323	462	82005	304	83405	103, 216	83639	89	83804	95
50205	383	60040	408	71461	371	77324	462	82006	304	83406	103, 216	83640	89	83805	95
50210	383	60270	169	71462	371	77325	462	82007	304	83407	103, 216	83642	89	83806	95
50215	383	60275	169	71470	133, 368	77331	462	82008	304	83408	104	83643	89	83810	95
50300	384	60310	169	71471	133, 368	77332	462	82010	304	83409	104	83645	89	83812	95
50305	384	60315	169	71472	133, 367	77333	462	82012	304	83410	104	83646	89	83814	95
50310	384	60380	169	71473	133, 367	77338	450	82013	129, 304	83411	103	83648	88	83816	95
50315	384	60385	169	71474	133, 367	77350	459	82014	304	83412	103	83649	88	83818	95
50400	384	60501	408	71475	133, 367	77351	459	82016	304	83414	104	83651	88	83820	95
50500	385	60502	408	71480	133, 368	77352	459	82017	304	83415	104	83652	88	83822	95
50501	385	60503	408	71481	133, 368	77353	459	82018	304	83417	103	83654	88	83824	95
50510	384	60504	408	71482	133, 368	77380	463	82019	129, 304	83418	103	83655	88	83826	95
50600	386	60505	408	71483	133, 368	77381	463	82020	304	83419	104	83657	88	83828	94, 116
50601	386	60509	407	71487	366	77382	463	82022	304	83424	125	83658	88	83830	94
50602	386	60510	407	71488	366	77383	463	82023	304	83426	125	83660	88	83832	94
50603	386	60511	407	71489	366	77384	463	82028	304	83433	102	83661	88	83834	94
50605	386	60512	407	71490	366, 372	77385	463	82029	129, 304	83434	102	83663	88	83836	94
50606	386	60514	408	71491	366, 372	79553	219	82030	304	83435	111	83664	88	83838	94
50607	386	60520	406	71498	366	79554	219	82032	304	83436	111	83666	88	83840	94
50608	386	60521	406	71499	366	8		82034	304	83437	111	83669	112	83842	125
50610	386	60522	406	71700	459	80021	302	82036	304	83438	111	83698	112	83843	125
50611	386	60523	406	71701	459	80022	302	82037	129, 304	83439	111	83699	112	83844	125
50612	386	60524	406	73500	449	80023	301	82038	304	83440	111	83700	112, 197, 203,	83845	125
50613	386	60525	404	73501	449	80024	301	82040	304	83441	111		226, 235	83847	441
50620	389	60526	404	73502	449	80025	301	82042	304	83442	111	83701	112, 197, 203,	83848	122, 179
50621	389	60527	404	73503	449	80026	301	82050	304	83443	111		226, 235	83851	122, 179
50622	389	60528	404	73504	449	80027	301	82051	304	83444	111	83702	112, 197, 203,	83862	111
50623	389	60530	407	73505	449	81000	299	82059	129, 304	83445	111		226	83863	111
50624	389	60531	407	73506	449	81095	299	82100	306	83446	111	83703	112, 197, 203,	83864	111
50625	389	60532	407	73507	449	81100	299	82101	305	83447	111		226	83865	111
50626	389	60533	407	73508	449	81101	299	82104	305	83448	111	83704	112	83866	111
50627	389	60534	407	73509	449	81102	299	82106	305	83449	111	83705	112	83867	93, 132, 190
50628	389	60535	405	73510	449	81104	299	82108	305	83450	104	83710	78	83868	93, 132, 190
50629	389	60536	405	73511	449	81106	299	82110	305	83451	104	83712	78	83869	103, 120, 241
50630	389	60537	405	73512	449	81108	299	82112	305	83452	104	83714	79	83871	111
50631	389	60538	404	73513	449	81109	299	82113	305	83453	104	83716	79	83872	111
50632	389	60539	404	73700	448	81116	294	82114	305	83454	104	83718	80	83873	111
50633	389	60540	407	73701	448	81191	300	82116	305	83455	104	83720	80	83874	111
50634	389	60541	407	73702	448	81195	300	82117	305	83456	104	83721	80	83875	93
50635	389	60542	407	73703	448	81198	303	82118	305	83457	104	83722	81	83876	93
50700	387	60550	410, 433	73710	448	81199	303	82119	305	83466	104	83723	80	83877	93
50701	387	60551	410, 433	73711	448	81200	299	82120	305	83467	104	83724	81	83878	116
50702	387	60552	410, 433	73712	448	81201	299	82122	305	83468	104	83725	80	83879	116
50703	387	60553	410, 433	73713	448	81202	299	82123	305	83469	104	83726	80	83880	112, 235
50705	387	60554	410, 433	73714	448	81204	299	82128	305	83479	102	83727	80	83881	112, 235
50706	387	61150	169	73719	448	81206	299	82129	305	83480	102	83728	80	83882	102
50707	387	61155	169	73725	448	81208	299	82130	305	83481	102	83729	79	83884	103
50708	387	61190	169	73726	448	81209	299	82132	305	83482	102	83730	80	83886	103
50710	388	61195	169	73727	448	81292	300	82134	305	83483	103	83731	79	83887	125
50711	388	61280	169	73739	449	81295	300	82136	305	83484	103	83732	80	83888	125
50712	388	61285	169	73740	449	81296	303	82137	305	83486	125	83733	79	83889	125
50713	388	61400	169	73741	449	81300	299	82138	305	83487	125	83734	82	83890	121, 467
50720	388	64001	295	73742	449	81302	299	82140	305	83488	363	83735	79	83891	121, 467
50721	388	64051	295	73743	449	81304	299	82142	305	83489	363	83736	82	83892	121, 467
50722	388	64151	295	73744	449	81306	299	82150	305	83490	102	83737	79	83893	121, 467
50723	388	64201	295	73750	448, 464	81308	299	82151	305	83491	102	83738	82	83894	111
50800	386	65010	295	74201	493	81391	300	82159	305	83492	102	83739	79	83895	111
50801	386	65020	295	74207	173	81395	300	82200	306	83497	106	83740	82	83896	111
50802	386	65030	295	74400	450	81400	299	82210	278	83498	106	83742	82	83897	118, 282
50803	386	65033	295	74401	450	81401	299	82215	278	83499	106	83744	82	83900	99
50805	387	65034	295	74402	450	81402	299	82300	306	83500	122	83748	129, 306	83901	99
50806	387	65035	295	74403	450	81404	299	82307	154	83513	122	83749	129, 306	83902	99
50807	387	65065	294	74404	450	81406	299	82308	154	83514	122	83750	129, 306	83903	99
50808	387	65066	294	74698	451	81408	299	82309	154	83536	435, 442	83751	129, 306	83904	99
50815	386	7		74699	451	81492	300	82310	155	83537	442	83752	129, 306	83905	99
50816	386	70303	460	74700	451	81495	300	82312	155	83538	442	83753	129, 306	83906	99
50817	386	71001	492	74701	451	81502	299	82314	155	83560	105	83754	129, 306	83907	99
50818	386	71002	492	74702	451	81504	299	82316	155	83561	105	83755	129, 306	83908	99
50820	387	71003	492	74703	451	81506	299	82318	156	83562	105	83756	129, 306	83909	99
50821	387	71004	492	74704	451	81591	300	82319	156	83563	105	83757	129, 306	83910	99
50822	387	71005	492	74705	451	81595	300	82328	156, 277	83564	105	83758	129, 306	83911	99
50823	387	71006	492	74706	451	81602	299	82338	156	83565	105	83759	129, 306	83912	99, 116
50900	385	71008	492	74721	451	81604	299	82345	155	83566	105	83760	128, 307	83913	99, 116
50905	385	71009	501	74722	451	81606	299	82346	156	83567	105	83761	128, 307	83914	99
50910	385	71010	501	74731	452	81608	299	82347	156	83568	104	83762	128, 307	83915	99
50915	385	71011	501	74732	4										

83951	130	84103	75	84200	115	84312	123	84476	59	85042	92	88842	476	93151	457
83952	130	84104	75	84202	115	84314	123	84477	59	85043	92	88843	476	93152	342
83953	130	84105	75	84205	63	84315	123	84478	59	88008	491	88844	476	93153	342
83954	130	84106	75	84206	63	84317	123	84479	59	88019	491	88845	477	93154	456
83955	67	84107	77	84207	63	84320	72	84480	59	88060	464	88846	338, 477	93155	456
83956	67	84108	77	84208	63	84321	72	84481	59	88061	464	88847	477	93156	456
83957	67	84109	77	84209	63	84322	72	84482	59	88062	464	88848	477	93157	456
83958	67	84110	76	84212	362	84323	72	84483	59	88080	459	88849	478	93160	358
83960	97	84111	76	84213	362	84324	73	84484	59	88081	459	88850	478	93161	359
83961	97	84112	76	84215	116	84325	73	84490	101	88090	459	88851	478	93162	359
83962	97	84113	76	84216	116	84326	73	84491	101	88099	493	88852	470	93163	456
83963	97	84114	77	84217	84, 123	84327	73	84492	101	88111	468	88853	478	93164	345
83964	97	84115	77	84218	84, 123	84328	73	84493	101	88122	455	88854	479	93165	345
83965	97	84116	77	84220	116	84329	73	84494	101	88123	455	88855	461	93166	349
83966	97	84117	76	84221	115	84330	73	84509	47	88133	455	88856	461	93167	349
83967	97	84118	76	84222	115	84331	73	84510	46	88134	455	88900	461	93168	349
83968	130	84119	76	84225	261	84332	73	84511	46	88144	302	88901	461	93169	349
83969	130	84120	86	84226	84	84333	73	84512	46	88244	302	88902	461	93170	359
83971	67	84121	86	84227	84	84334	73	84514	47	88245	302	88903	461	93171	350
83980	67, 312	84122	86	84229	87	84335	73	84515	46	88246	302	88910	461	93172	352
83981	67	84123	86	84230	87	84336	73	84517	47	88247	302	88911	461	93173	349
83991	114	84124	86	84231	87	84337	73	84519	49	88248	302	88912	461	93174	350
83992	66	84125	86	84232	87	84340	79	84520	49	88249	302	88920	479	93175	336
83993	114	84126	86	84233	87	84341	79	84521	49	88250	302	88921	479	93179	341
83994	66	84127	86	84234	87	84342	79	84522	49	88255	449	88922	479	93180	339
83995	114	84128	85, 124	84235	117	84343	79	84523	48	88256	449	88923	479	93181	339
83996	115, 172	84129	85	84236	117	84344	79	84524	48	88271	457	88924	479	93182	339
83997	114	84130	85	84237	117	84345	79	84525	48	88285	303, 464	88925	479	93183	339
83998	438	84131	85	84238	117	84346	79	84526	48	88287	468	88926	479	93189	346
83999	438	84132	85	84240	68	84347	79	84528	48	88288	468	88927	479	93190	337
84000	109	84133	85	84241	68	84348	79	84529	48	88598	131, 502	88928	480	93191	337
84001	109	84134	85	84242	68	84349	79	84530	48	88601	491	88929	480	93192	337, 501
84002	109	84135	85	84243	68	84350	79	84531	113, 258, 311,	88607	452	88930	483	93193	338
84003	109	84136	85	84244	67, 106	84351	79	84532	79	88608	486	88931	480	93194	338
84004	109	84137	86	84245	67, 106	84352	79	84533	113, 258, 311,	88609	132, 502	88932	480	93195	501
84005	109	84140	124	84246	69	84353	79	84534	113, 258, 460	88617	451	88933	480	93196	501
84006	109	84141	124	84247	69	84354	79	84535	113, 258, 460	88618	451	88934	480	93200	335
84007	109	84142	124	84248	69	84355	79	84536	310, 397	88626	131, 502	88935	481	93201	340
84017	119	84143	124	84250	119, 186	84360	64	84535	310, 397	88627	131, 502	88936	481	93202	358
84018	119	84144	74	84251	119, 186	84361	64	84536	310, 397	88628	131, 502	88937	481	93206	358
84020	134	84145	74	84252	119, 186	84362	64	84540	52	88631	483	88938	481	93207	358
84021	134	84146	74	84253	119, 186	84363	64	84541	52	88636	132, 502	88939	481	93211	341
84022	83	84147	74	84255	62	84364	64	84542	52	88637	486	88940	481	93212	341
84023	83	84148	74	84256	60	84365	50	84543	52	88640	485	88941	481	93213	346
84024	83	84149	74	84257	69	84366	50	84544	52	88642	485	88942	481	93214	346
84025	83	84150	127	84258	69	84367	50	84545	53	88643	498	88943	481	93220	335
84026	83	84151	127	84259	69	84373	50	84546	53	88644	498	88944	482	93222	457
84028	117	84152	127	84260	87	84374	50	84549	53	88645	498	88945	482	93223	457
84029	117	84153	127	84261	87	84375	51	84550	53	88675	490	88946	482	93224	457
84035	132	84155	127	84262	62	84376	51	84551	53	88688	491	88947	482	93225	141, 456
84036	132	84156	127	84263	62	84377	51	84552	53	88701	483	88948	482	93226	141, 456
84039	423	84157	127	84264	62	84378	51	84553	53	88708	490	88949	482	93240	456
84040	92	84158	84, 124	84265	62, 172	84379	51	84554	53	88709	490	9		93241	456
84041	92	84159	127	84266	60	84380	51	84555	57	88710	490	90901	242	93242	456
84042	92	84160	127	84267	60	84381	51	84556	57	88712	490	90902	242, 243	93243	456
84043	92	84161	74	84268	60	84383	91	84557	58	88713	490	93034	342	93244	456
84045	182	84162	127	84269	60, 172	84385	91	84558	57	88714	490	93101	343	93245	456
84046	105, 121, 206	84163	127	84270	71	84387	91	84559	57	88717	450	93102	359	93298	356
84047	105, 121, 206	84164	127	84271	71	84405	216	84560	58	88718	450	93105	262, 343	93299	352
84048	105, 121, 206	84165	74	84272	71	84406	216	84561	57	88727	483	93108	357	93300	344
84050	127	84166	127	84273	71	84407	216	84562	57	88733	457	93109	357	93301	351
84051	127	84167	127	84274	71	84408	104	84563	58	88734	457	93110	355	93302	351
84052	127	84168	74	84275	71	84409	104	84564	57	88811	470	93111	356	93303	349
84053	127	84169	127	84276	71	84410	104	84565	57	88812	470	93112	355	93304	349
84054	127	84170	74	84277	71	84411	104	84566	58	88813	470	93114	355	93305	344
84055	127	84171	74	84280	71	84415	104	84567	55	88814	471	93115	355	93306	338, 458
84056	127	84172	74	84281	71	84416	104	84568	55	88815	471	93116	345	93307	338, 458
84057	127	84173	127	84282	71	84417	104	84569	55	88816	471	93120	345	93308	356
84058	127	84174	76	84283	71	84418	104	84570	55	88817	471	93121	345	93309	356
84059	127	84176	127	84284	71	84420	104	84571	55	88818	471	93122	351	93310	333
84060	127	84177	61	84285	71	84421	104	84572	55	88819	471	93123	359	93311	333
84061	127	84178	61	84286	71	84422	104	84573	55	88820	471	93124	352	93312	344
84062	127	84179	61	84287	71	84423	104	84574	55	88821	471	93125	351	93313	344
84063	127	84180	65	84290	70	84429	105	84575	54	88822	471	93126	357	93314	349
84064	127	84181	65	84291	70	84430	105	84576	54	88823	472	93127	357	93315	349
84065	127	84182	65	84292	70	84440	105	84577	55	88824	472	93128	342	93316	339
84066	127	84183	65	84293	70	84441	105	84578	55	88825	472	93129	342	93317	347
84067	127	84184	65	84295	70	84442	105	84579	55	88826	472	93134	342	93318	343
84068	127	84185	64, 192	84296	70	84450	123	84580	55	88827	472	93135	356	93319	355
84069	127	84186	64, 194	84297	70	84452	123	84581	55	88828	473	93136	340	93320	355
84073	127	84187	64	84298	70	84454	123	84582	55	88829	473	93137	340	93321	309
84076	127	84188	64	84300	129, 306	84456	123	84785	90	88830	473	93138	340	93400	354
84080	110	84189	64, 193	84301	129, 306	84458	123	84786	90	88831	473	93139	340	94144	353
84081</															

Nuove forme per la ristorazione  
**VULCANIA**

 **Tognana** PORCELLANE

E-mail: [info@tognanaporcellane.it](mailto:info@tognanaporcellane.it)  
<http://www.tognanaporcellane.it>



**DICK**

Traditionsmarke der Profis

Unsere Inspirierenden  
**Red Spirit**



**TYPISCH F. DICK!**

Messer – so individuell wie der Mensch



[www.dick.de](http://www.dick.de)

Messer . Werkzeuge . Wetzstähle . Schleifmaschinen



SUPPLIER OF GOODFOODMOOD®



# GOODFOODMOOD

MODERNE KONZEPTE FÜR  
DEN GEDECKTEN TISCH

## Atmosphäre schaffen. Mit Verantwortung.

Atmosphäre schaffen. Mit Verantwortung - dafür steht Duni und wir hören nicht auf, immer wieder neue, trendgerechte Varianten nachhaltiger Tischdekoration zu entwickeln. So können Sie sicher sein - mit Duni treffen Sie immer die erste Wahl in Sachen Nachhaltigkeit, Qualität und Stil.



gegr. 1892

## Wilh. Breuer

## Gastronomie - Vollausstatter

- Großküchentechnik von A - Z
- Geräte, Maschinen & Zubehör
- Porzellan, Besteck, Gläser ...
- Küchenwerkzeuge & Food
- Verpackungsbedarf
- Betriebshygiene

## Unser Plus an Service

- Zustellung durch eigenen Fuhrpark
- Fachberatung durch unser geschultes Team
- 3D Küchenplanung und Ausführung
- Reparaturservice vor Ort
- Finanzierung durch Leasing
- Hygiene Lösung nach HACCP



## Profi Center Düsseldorf

• Pinienstr. 11 • 40233 Düsseldorf • Tel.: 0211 - 944 06 0 • Mail: info@breuerinfo.de

[www.breuerinfo.de](http://www.breuerinfo.de)

no. 03826



€ 4 004133 038264